

FCC Information and Copyright

This equipment has been tested and found to comply with the limits of a Class B digital device, pursuant to Part 15 of the FCC Rules. These limits are designed to provide reasonable protection against harmful interference in a residential installation. This equipment generates, uses, and can radiate radio frequency energy and, if not installed and used in accordance with the instructions, may cause harmful interference to radio communications. There is no guarantee that interference will not occur in a particular installation.

The vendor makes no representations or warranties with respect to the contents here and specially disclaims any implied warranties of merchantability or fitness for any purpose. Further the vendor reserves the right to revise this publication and to make changes to the contents here without obligation to notify any party beforehand.

Duplication of this publication, in part or in whole, is not allowed without first obtaining the vendor's approval in writing.

The content of this user's manual is subject to be changed without notice and we will not be responsible for any mistakes found in this user's manual. All the brand and product names are trademarks of their respective companies.

Table of Contents

Chapter 1: INTRODUCTION	3
1.1 Before You Start	3
1.2 Package Checklist	3
1.3 Motherboard Features	4
1.4 Rear Panel Connectors (for Ver 5.x)	6
1.5 Rear Panel Connectors (for Ver 6.x)	6
1.6 Motherboard Layout	7
Chapter 2: Hardware Installation	8
2.1 Installing Central Processing Unit (CPU)	8
2.2 Fan Headers	9
2.3 Installing System Memory	10
2.4 Connectors and Slots	11
Chapter 3: Headers & Jumpers Setup	13
3.1 How to Setup Jumpers	13
3.2 Detail Settings	13
Chapter 4: USEFUL HELP	19
4.1 Driver Installation Note	19
4.2 Award BIOS Beep Code	20
4.3 Extra Information	20
4.4 Troubleshooting	22
Chapter 5: WarpSpeeder™	23
5.1 Introduction	23
5.2 System Requirement	23
5.3 Installation	24
5.4 WarpSpeeder™	25
Appendices: SPEC In Other Language	32
German	32
France	34
Italian	36
Spanish	38
Portuguese	40
Polish	42
Russian	44
Arabic	46
Japanese	48

CHAPTER 1: INTRODUCTION

1.1 BEFORE YOU START

Thank you for choosing our product. Before you start installing the motherboard, please make sure you follow the instructions below:

- Prepare a dry and stable working environment with sufficient lighting.
- Always disconnect the computer from power outlet before operation.
- Before you take the motherboard out from anti-static bag, ground yourself properly by touching any safely grounded appliance, or use grounded wrist strap to remove the static charge.
- Avoid touching the components on motherboard or the rear side of the board unless necessary. Hold the board on the edge, do not try to bend or flex the board.
- Do not leave any unfastened small parts inside the case after installation. Loose parts will cause short circuits which may damage the equipment.
- Keep the computer from dangerous area, such as heat source, humid air and water.

1.2 PACKAGE CHECKLIST

- ✚ HDD Cable X 1
- ✚ User's Manual X 1
- ✚ Fully Setup Driver CD X 1
- ✚ Rear I/O Panel for ATX Case X 1
- ✚ FDD Cable X 1 (optional)
- ✚ Serial ATA Cable X 1 (optional)
- ✚ USB 2.0 Cable X1 (optional)
- ✚ S/PDIF Cable X 1 (optional)
- ✚ Serial ATA Power Cable X 1 (optional)

1.3 MOTHERBOARD FEATURES

	<i>Ver 5.x</i>	<i>Ver 6.x</i>
CPU	Socket 478 Intel Pentium 4 / Celeron D processor up to 3.4 GHz (Do not support Willamette CPU.) Supports Hyper Threading technology *It is recommended to use processors with 95W power consumption.	Socket 478 Intel Pentium 4 / Celeron D processor up to 3.4 GHz (Do not support Willamette CPU.) Supports Hyper Threading technology *It is recommended to use processors with 95W power consumption.
FSB	400 / 533 / 800 MHz	400 / 533 / 800 MHz
Chipset	VIA P4M900 VIA VT8237A	VIA P4M900 VIA VT8237A
Graphic	Chrome9 HC 3D / 2D Graphics Max Shared Video Memory is 256 MB	Chrome9 HC 3D / 2D Graphics Max Shared Video Memory is 256 MB
Super I/O	ITE 8712F Provides the most commonly used legacy Super I/O functionality. Low Pin Count Interface Environment Control initiatives, H/W Monitor Fan Speed Controller ITE's "Smart Guardian" function	ITE 8712F Provides the most commonly used legacy Super I/O functionality. Low Pin Count Interface Environment Control initiatives, H/W Monitor Fan Speed Controller ITE's "Smart Guardian" function
Main Memory	DIMM Slots x 2 Supports DDR2 533 / 667 Each DIMM supports 256/512MB/1GB/2GB DDR2 Max Memory Capacity 4GB Single Channel Mode DDR2 memory module Registered DIMM and ECC DIMM is not supported	DIMM Slots x 2 Supports DDR2 533 / 667 Each DIMM supports 256/512MB/1GB/2GB DDR2 Max Memory Capacity 4GB Single Channel Mode DDR2 memory module Registered DIMM and ECC DIMM is not supported
IDE	Integrated IDE Controller Ultra DMA 33~133 Bus Master Mode supports PIO Mode 0~4,	Integrated IDE Controller Ultra DMA 33~133 Bus Master Mode supports PIO Mode 0~4,
SATA	Integrated Serial ATA Controller Data transfer rates up to 1.5 Gb/s. SATA Version 1.0 specification compliant.	Integrated Serial ATA Controller Data transfer rates up to 1.5 Gb/s. SATA Version 1.0 specification compliant.

	<i>Ver 5.x</i>	<i>Ver 6.x</i>
LAN PHY	Realtek RTL 8201CL PHY 10 / 100 Mb/s auto negotiation Half / Full duplex capability	Realtek RTL 8201CL PHY 10 / 100 Mb/s auto negotiation Half / Full duplex capability
Sound Codec	ALC883 7.1 channels audio out High-Definition Audio support	ALC861VD 5.1 channels audio out High-Definition Audio support
Slots	PCI Express x 16 slot x1 PCI Express x 1 slot x1 PCI slot x2	PCI Express x 16 slot x1 PCI Express x 1 slot x1 PCI slot x2
On Board Connector	Floppy connector x1 Printer Port connector x1 IDE Connector x2 SATA Connector x2 Front Panel Connector x1 Front Audio Connector x1 CD-in Connector x1 S/PDIF out connector x1 CPU Fan header x1 System Fan header x1 Clear CMOS header x1 USB connector x2 Power Connector (24pin) x1 Power Connector (4pin) x1	Floppy connector x1 Printer Port connector x1 IDE Connector x2 SATA Connector x2 Front Panel Connector x1 Front Audio Connector x1 CD-in Connector x1 S/PDIF out connector x1 CPU Fan header x1 System Fan header x1 Clear CMOS header x1 USB connector x2 Power Connector (24pin) x1 Power Connector (4pin) x1
Back Panel I/O	PS/2 Keyboard x1 PS/2 Mouse x1 Serial Port x1 VGA Port x1 LAN port x1 USB Port x4 Audio Jack x6	PS/2 Keyboard x1 PS/2 Mouse x1 Serial Port x1 VGA Port x1 LAN port x1 USB Port x4 Audio Jack x3
Board Size	190 mm (W) x 244 mm (L)	190 mm (W) x 244 mm (L)
OS Support	Windows 2000 / XP / VISTA Biostar Reserves the right to add or remove support for any OS with or without notice.	Windows 2000 / XP / VISTA Biostar Reserves the right to add or remove support for any OS with or without notice.

1.4 REAR PANEL CONNECTORS (FOR VER 5.x)

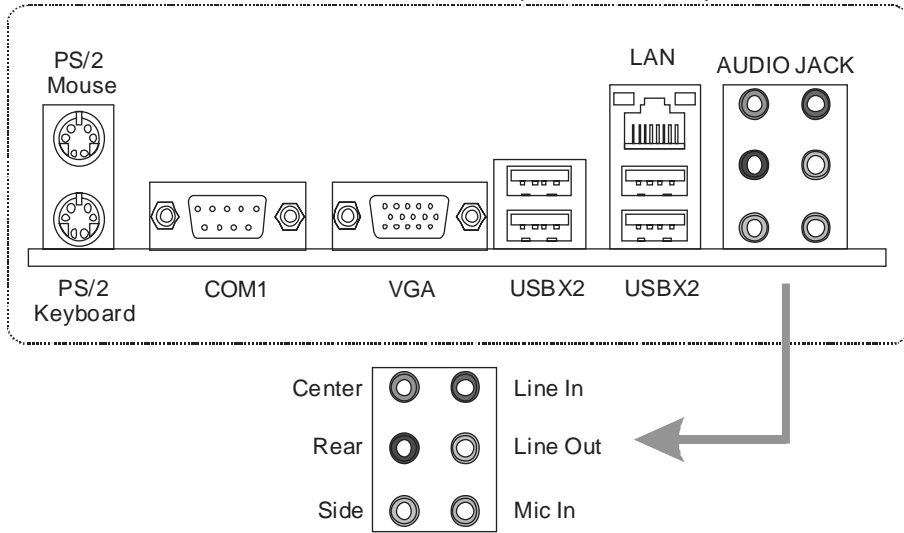

1.5 REAR PANEL CONNECTORS (FOR VER 6.x)

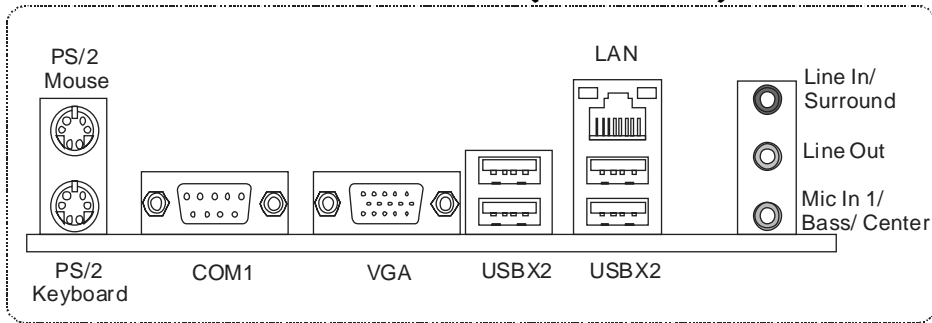

Since the audio chip supports High Definition Audio Specification, the function of each audio jack can be defined by software. The input / output function of each audio jack listed above represents the default setting. However, when connecting external microphone to the audio port, please use the Line In (blue) and Mic In (Pink) audio jack.

1.6 MOTHERBOARD LAYOUT

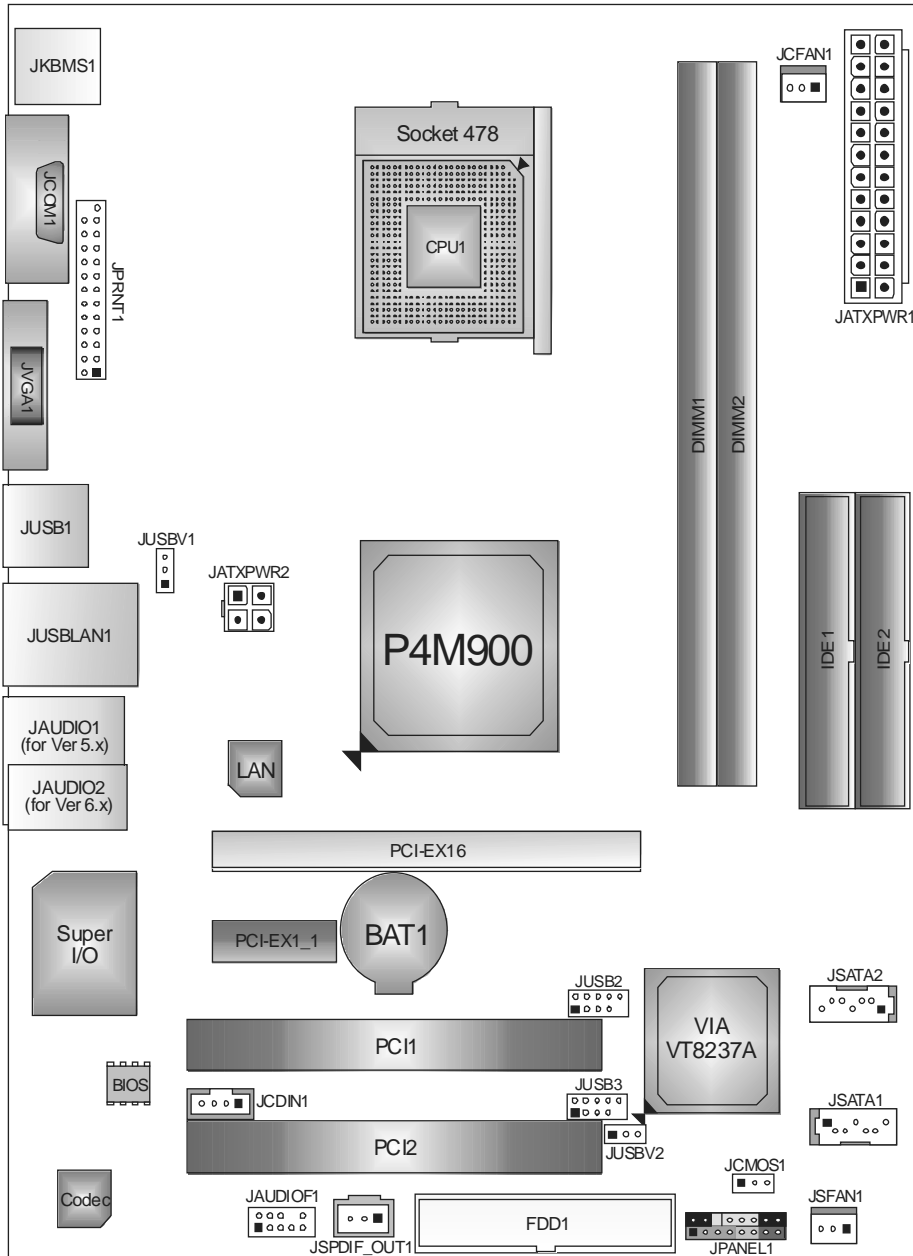

Note: ■ represents the 1st pin.

CHAPTER 2: HARDWARE INSTALLATION

2.1 INSTALLING CENTRAL PROCESSING UNIT (CPU)

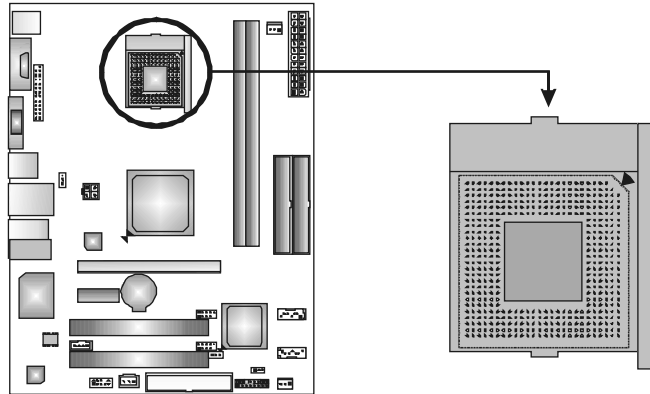

Step 1: Pull the lever sideways away from the socket and then raise the lever up to a 90-degree angle.

Step 2: Look for the white dot/cut edge. The white dot/cut edge should point wards the lever pivot. The CPU will fit only in the correct orientation.

Step 3: Hold the CPU down firmly, and then close the lever to complete the installation.

Step 4: Put the CPU Fan on the CPU and buckle it. Connect the CPU FAN power cable to the JCFAN1. This completes the installation.

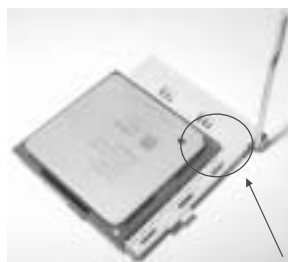

2.2 FAN HEADERS

These fan headers support cooling-fans built in the computer. The fan cable and connector may be different according to the fan manufacturer. Connect the fan cable to the connector while matching the black wire to pin#1.

JCFAN1: CPU Fan Header

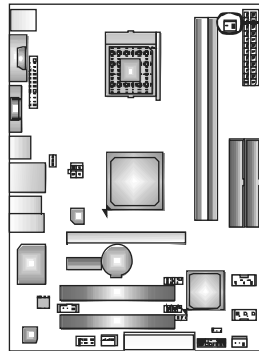

Pin	Assignment
1	Ground
2	+12V
3	FAN RPM rate sense

JSFAN1: System Fan Header

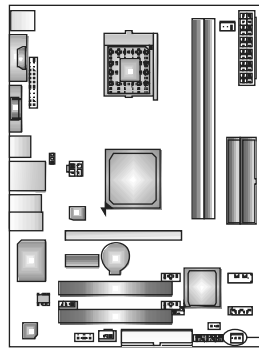

Pin	Assignment
1	Ground
2	+12V
3	FAN RPM rate sense

Note:

The JCFAN1/JSFAN1 support 3-pin head connector. When connecting with wires onto connectors, please note that the red wire is the positive and should be connected to pin#2, and the black wire is Ground and should be connected to GND.

2.3 INSTALLING SYSTEM MEMORY

A. Memory Modules

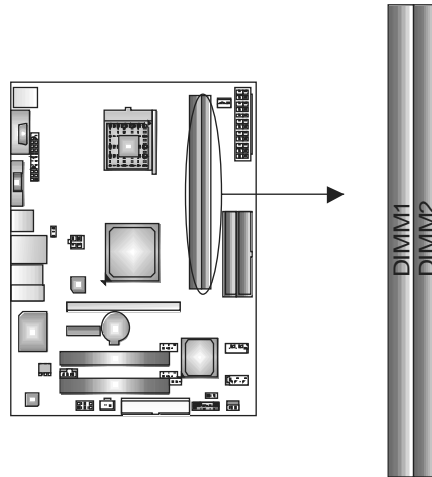

1. Unlock a DIMM slot by pressing the retaining clips outward. Align a DIMM on the slot such that the notch on the DIMM matches the break on the Slot.

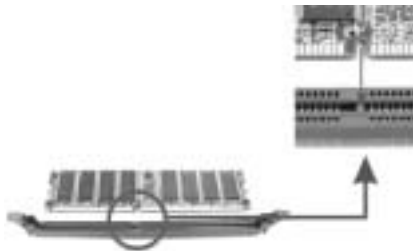

2. Insert the DIMM vertically and firmly into the slot until the retaining chip snap back in place and the DIMM is properly seated.

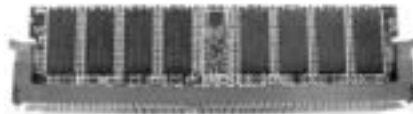

B. Memory Capacity

DIMM Socket Location	DDR Module	Total Memory Size
DIMM1	256MB/512MB/1GB/2GB	Max is 4GB.
DIMM2	256MB/512MB/1GB/2GB	

2.4 CONNECTORS AND SLOTS

FDD1: Floppy Disk Connector

The motherboard provides a standard floppy disk connector that supports 360K, 720K, 1.2M, 1.44M and 2.88M floppy disk types. This connector supports the provided floppy drive ribbon cables.

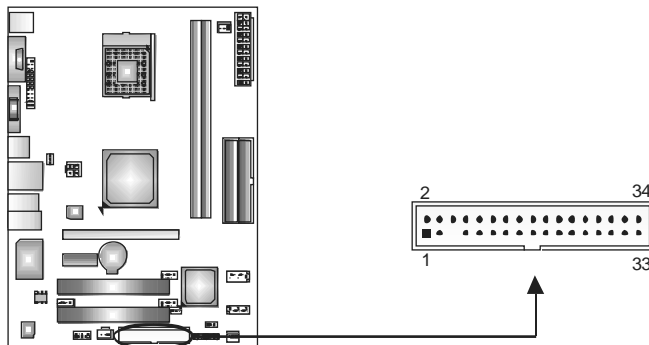

IDE1/IDE2: Hard Disk Connectors

The motherboard has a 32-bit Enhanced PCI IDE Controller that provides PIO Mode 0~4, Bus Master, and Ultra DMA 33/66/100/133 functionality. It has two HDD connectors IDE1 (primary) and IDE2 (secondary).

The IDE connectors can connect a master and a slave drive, so you can connect up to four hard disk drives. The first hard drive should always be connected to IDE1.

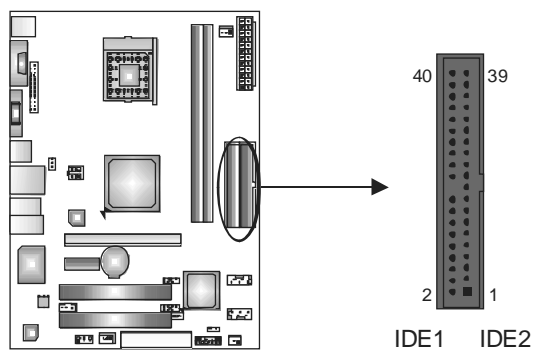

PCI-EX16: PCI-Express x16 Slot

- PCI-Express 1.0a compliant.
- Maximum theoretical realized bandwidth of 4GB/s simultaneously per direction, for an aggregate of 8GB/s totally.

PCI-EX1_1: PCI-Express x1 Slot

- PCI-Express 1.0a compliant.
- Data transfer bandwidth up to 250MB/s per direction; 500MB/s in total.
- PCI-Express supports a raw bit-rate of 2.5Gb/s on the data pins.
- 2X bandwidth over the traditional PCI architecture.

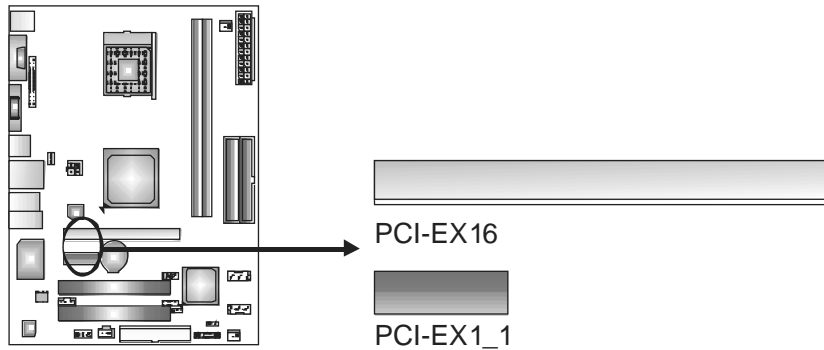

PCI1~PCI2: Peripheral Component Interconnect Slots

This motherboard is equipped with 2 standard PCI slots. PCI stands for Peripheral Component Interconnect, and it is a bus standard for expansion cards. This PCI slot is designated as 32 bits.

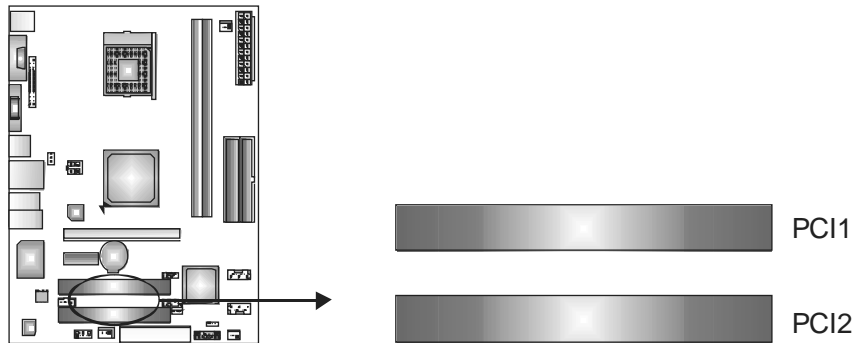

CHAPTER 3: HEADERS & JUMPERS SETUP

3.1 HOW TO SETUP JUMPERS

The illustration shows how to set up jumpers. When the jumper cap is placed on pins, the jumper is “close”, if not, that means the jumper is “open”.



3.2 DETAIL SETTINGS

JPANEL1: Front Panel Header

This 16-pin connector includes Power-on, Reset, HDD LED, Power LED, Sleep button and speaker connection. It allows user to connect the PC case's front panel switch functions.

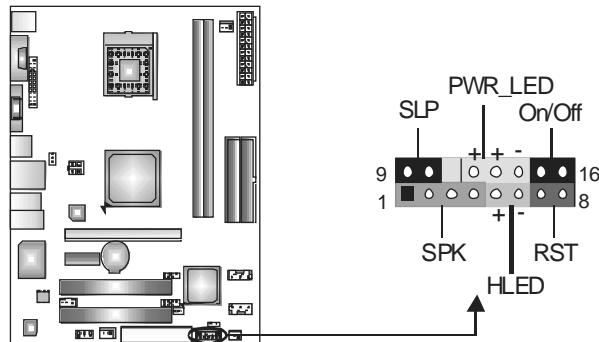

Pin	Assignment	Function	Pin	Assignment	Function
1	+5V	Speaker Connector	9	Sleep control	Sleep button
2	N/A		10	Ground	
3	N/A		11	N/A	N/A
4	Speaker	Hard drive LED	12	Power LED (+)	Power LED
5	HDD LED (+)		13	Power LED (+)	
6	HDD LED (-)		14	Power LED (-)	
7	Ground	Reset button	15	Power button	Power-on button
8	Reset control		16	Ground	

ATX Power Source Connector: JATXPWR1

JATXPWR1 allows user to connect 24-pin power connector on the ATX power supply.

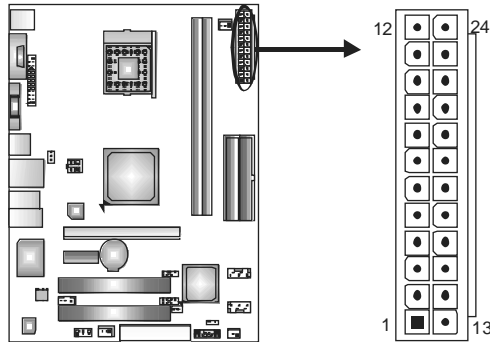

Pin	Assignment	Pin	Assignment
13	+3.3V	1	+3.3V
14	-12V	2	+3.3V
15	Ground	3	Ground
16	PS_ON	4	+5V
17	Ground	5	Ground
18	Ground	6	+5V
19	Ground	7	Ground
20	NC	8	PW_OK
21	+5V	9	Standby Voltage+5V
22	+5V	10	+12V
23	+5V	11	+12V
24	Ground	12	+3.3V

JATXPWR2: ATX Power Source Connector

By connecting this connector, it will provide +12V to CPU power circuit.

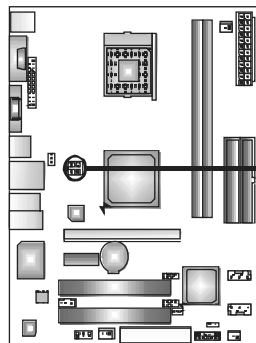

Pin	Assignment
1	+12V
2	+12V
3	Ground
4	Ground

JUSB2/JUSB3: Headers for USB 2.0 Ports at Front Panel

This header allows user to connect additional USB cable on the PC front panel, and also can be connected with internal USB devices, like USB card reader.

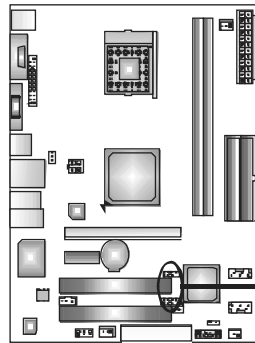

Pin	Assignment
1	+5V (fused)
2	+5V (fused)
3	USB-
4	USB-
5	USB+
6	USB+
7	Ground
8	Ground
9	Key
10	NC

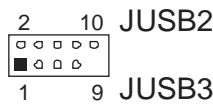

JUSBV1/JUSBV2: Power Source Headers for USB Ports

Pin 1-2 Close:

JUSBV1: +5V for USB ports at JUSB1/JUSBLAN1.

JUSBV2: +5V for USB ports at front panel (JUSB2/JUSB3).

Pin 2-3 Close:

JUSBV1: USB ports at JUSB1/JUSBLAN1 are powered by +5V standby voltage.

JUSBV2: USB ports at front panel (JUSB2/JUSB3) are powered by +5V standby voltage.

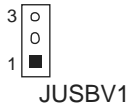
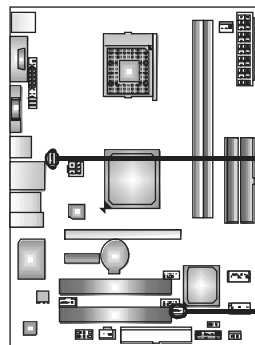

JUSBV1

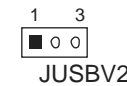

JUSBV2

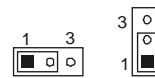

Pin 1-2 close

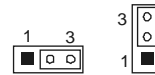

Pin 2-3 close

Note:

In order to support this function "Power-On system via USB device," "JUSBV1/ JUSBV2" jumper cap should be placed on Pin 2-3 individually.

JAUDIOF1: Front Panel Audio Header

This header allows user to connect the front audio output cable with the PC front panel. It will disable the output on back panel audio connectors.

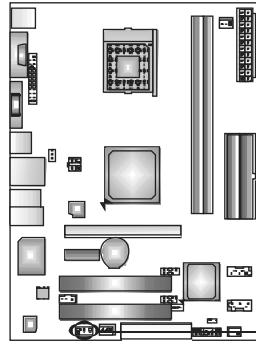

Pin	Assignment
1	Mic Left in
2	Ground
3	Mic Right in
4	GPIO
5	Right line in
6	Jack Sense
7	Front Sense
8	Key
9	Left line in
10	Jack Sense

JCDIN1: CD-ROM Audio-in Connector

This connector allows user to connect the audio source from the variety devices, like CD-ROM, DVD-ROM, PCI sound card, PCI TV turner card etc.

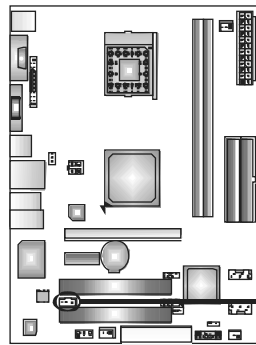

Pin	Assignment
1	Left Channel Input
2	Ground
3	Ground
4	Right Channel Input

JSPDIF_OUT1: Digital Audio-out Connector

This connector allows user to connect the PCI bracket SPDIF output header.

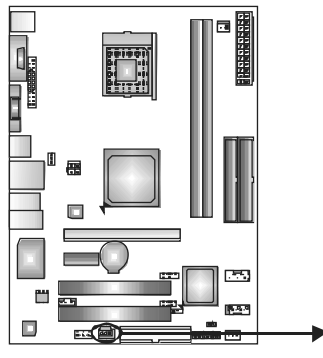

Pin	Assignment
1	+5V
2	SPDIF_OUT
3	Ground

JCMOS1: Clear CMOS Header

By placing the jumper on pin2-3, it allows user to restore the BIOS safe setting and the CMOS data, please carefully follow the procedures to avoid damaging the motherboard.

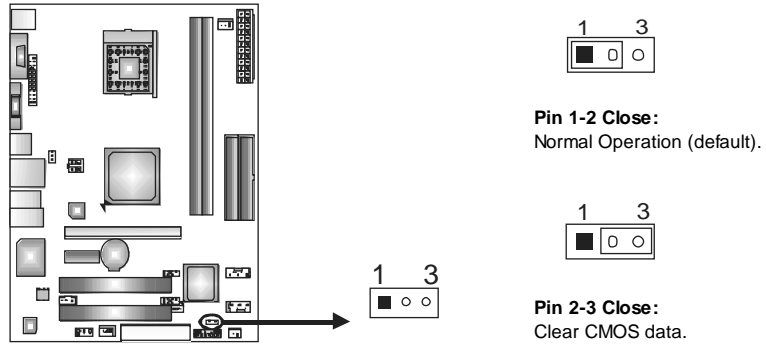

※ Clear CMOS Procedures:

1. Remove AC power line.
2. Set the jumper to "Pin 2-3 close".
3. Wait for five seconds.
4. Set the jumper to "Pin 1-2 close".
5. Power on the AC.
6. Reset your desired password or clear the CMOS data.

JSATA1~JSATA2: Serial ATA Connectors

The motherboard has a PCI to SATA Controller with 2 channels SATA interface, it satisfies the SATA 1.0 spec and with transfer rate of 1.5Gb/s.

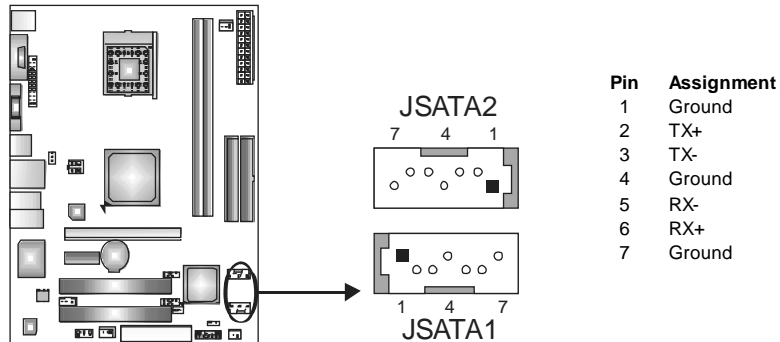

JPRNT1: Printer Port Connector

This header allows you to connector printer on the PC.

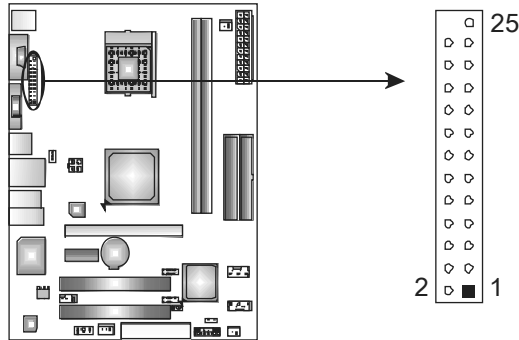

Pin	Assignment	Pin	Assignment
1	-Strobe	14	Ground
2	-ALF	15	Data 6
3	Data 0	16	Ground
4	-Error	17	Data 7
5	Data 1	18	Ground
6	-Init	19	-ACK
7	Data 2	20	Ground
8	-Sctin	21	Busy
9	Data 3	22	Ground
10	Ground	23	PE
11	Data 4	24	Ground
12	Ground	25	SCLT
13	Data 5	26	Key

CHAPTER 4: USEFUL HELP

4.1 DRIVER INSTALLATION NOTE

After you installed your operating system, please insert the Fully Setup Driver CD into your optical drive and install the driver for better system performance.

You will see the following window after you insert the CD

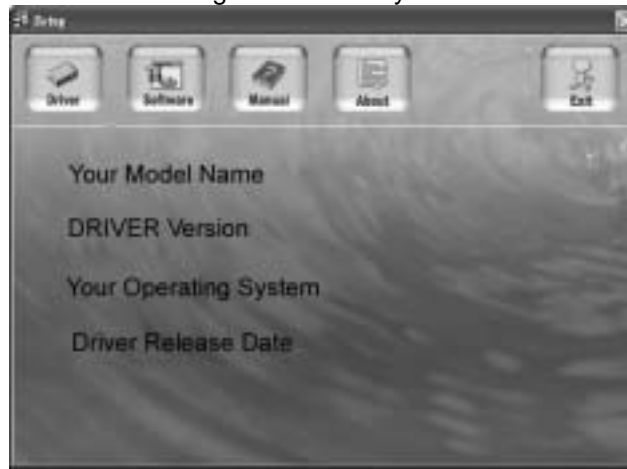

The setup guide will auto detect your motherboard and operating system.

Note:

If this window didn't show up after you insert the Driver CD, please use file browser to locate and execute the file **SETUP.EXE** under your optical drive.

A. Driver Installation

To install the driver, please click on the Driver icon. The setup guide will list the compatible driver for your motherboard and operating system. Click on each device driver to launch the installation program.

B. Software Installation

To install the software, please click on the Software icon. The setup guide will list the software available for your system, click on each software title to launch the installation program.

C. Manual

Aside from the paperback manual, we also provide manual in the Driver CD. Click on the Manual icon to browse for available manual.

Note:

You will need Acrobat Reader to open the manual file. Please download the latest version of Acrobat Reader software from <http://www.adobe.com/products/acrobat/readstep2.html>

4.2 AWARD BIOS BEEP CODE

Beep Sound	Meaning
One long beep followed by two short beeps	Video card not found or video card memory bad
High-low siren sound	CPU overheated System will shut down automatically
One Short beep when system boot-up	No error found during POST
Long beeps every other second	No DRAM detected or install

4.3 EXTRA INFORMATION

A. BIOS Update

After you fail to update BIOS or BIOS is invaded by virus, the Boot-Block function will help to restore BIOS. If the following message is shown after boot-up the system, it means the BIOS contents are corrupted.



In this Case, please follow the procedure below to restore the BIOS:

1. Make a bootable floppy disk.
2. Download the Flash Utility "AWDFLASH.exe" from the Biostar website: www.biostar.com.tw
3. Confirm motherboard model and download the respectively BIOS from Biostar website.
4. Copy "AWDFLASH.exe" and respectively BIOS into floppy disk.
5. Insert the bootable disk into floppy drive and press Enter.
6. System will boot-up to DOS prompt.
7. Type "*Awdflash xxxx.bf/sn/py/r*" in DOS prompt.
(xxxx means BIOS name.)
8. System will update BIOS automatically and restart.
9. The BIOS has been recovered and will work properly.

B. CPU Overheated

If the system shutdown automatically after power on system for seconds, that means the CPU protection function has been activated.

When the CPU is over heated, the motherboard will shutdown automatically to avoid a damage of the CPU, and the system may not power on again.

In this case, please double check:

1. The CPU cooler surface is placed evenly with the CPU surface.
2. CPU fan is rotated normally.
3. CPU fan speed is fulfilling with the CPU speed.

After confirmed, please follow steps below to relief the CPU protection function.

1. Remove the power cord from power supply for seconds.
2. Wait for seconds.
3. Plug in the power cord and boot up the system.

Or you can:

1. Clear the CMOS data.
(See "Close CMOS Header: JCMOS1" section)
2. Wait for seconds.
3. Power on the system again.

4.4 TROUBLESHOOTING

Probable	Solution
1. No power to the system at all Power light don't illuminate, fan inside power supply does not turn on. 2. Indicator light on keyboard does not turn on.	1. Make sure power cable is securely plugged in. 2. Replace cable. 3. Contact technical support.
System inoperative. Keyboard lights are on, power indicator lights are lit, and hard drive is spinning.	Using even pressure on both ends of the DIMM, press down firmly until the module snaps into place.
System does not boot from hard disk drive, can be booted from optical drive.	1. Check cable running from disk to disk controller board. Make sure both ends are securely plugged in; check the drive type in the standard CMOS setup. 2. Backing up the hard drive is extremely important. All hard disks are capable of breaking down at any time.
System only boots from optical drive. Hard disk can be read and applications can be used but booting from hard disk is impossible.	1. Back up data and applications files. 2. Reformat the hard drive. Re-install applications and data using backup disks.
Screen message says "Invalid Configuration" or "CMOS Failure."	Review system's equipment. Make sure correct information is in setup.
Cannot boot system after installing second hard drive.	1. Set master/slave jumpers correctly. 2. Run SETUP program and select correct drive types. Call the drive manufacturers for compatibility with other drives.

CHAPTER 5: WARPSPEEDER™



5.1 INTRODUCTION

[WarpSpeeder™], a new powerful control utility, features three user-friendly functions including Overclock Manager, Overvoltage Manager, and Hardware Monitor.

With the Overclock Manager, users can easily adjust the frequency they prefer or they can get the best CPU performance with just one click. The Overvoltage Manager, on the other hand, helps to power up CPU core voltage and Memory voltage. The cool Hardware Monitor smartly indicates the temperatures, voltage and CPU fan speed as well as the chipset information. Also, in the About panel, you can get detail descriptions about BIOS model and chipsets. In addition, the frequency status of CPU, memory, AGP and PCI along with the CPU speed are synchronically shown on our main panel.

Moreover, to protect users' computer systems if the setting is not appropriate when testing and results in system fail or hang, [WarpSpeeder™] technology assures the system stability by automatically rebooting the computer and then restart to a speed that is either the original system speed or a suitable one.

5.2 SYSTEM REQUIREMENT

OS Support: Windows 98 SE, Windows Me, Windows 2000, Windows XP
DirectX: DirectX 8.1 or above. (The Windows XP operating system includes DirectX 8.1. If you use Windows XP, you do not need to install DirectX 8.1.)

5.3 INSTALLATION

1. Execute the setup execution file, and then the following dialog will pop up. Please click “Next” button and follow the default procedure to install.

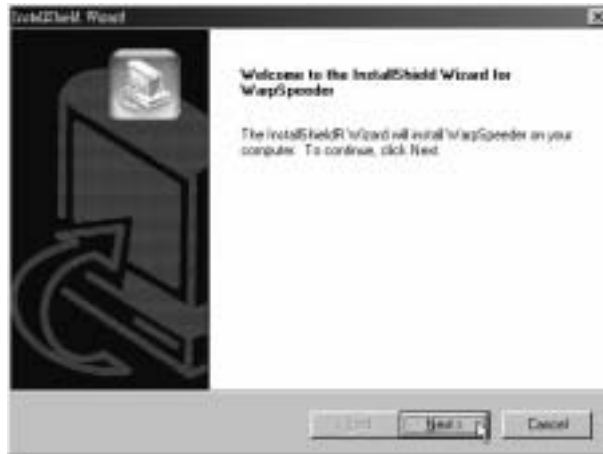

2. When you see the following dialog in setup procedure, it means setup is completed. If the “Launch the WarpSpeeder Tray Utility” checkbox is checked, the Tray Icon utility and [WarpSpeeder™] utility will be automatically and immediately launched after you click “Finish” button.



Usage:

The following figures are just only for reference, the screen printed in this user manual will change according to your motherboard on hand.

5.4 WARPSPEDER™

1. Tray Icon

Whenever the Tray Icon utility is launched, it will display a little tray icon on the right side of Windows Taskbar.



This utility is responsible for conveniently invoking [WarpSpeeder™] Utility. You can use the mouse by clicking the left button in order to invoke [WarpSpeeder™] directly from the little tray icon or you can right-click the little tray icon to pop up a popup menu as following figure. The "Launch Utility" item in the popup menu has the same function as mouse left-click on tray icon and "Exit" item will close Tray Icon utility if selected.



2. Main Panel

If you click the tray icon, [WarpSpeeder™] utility will be invoked. Please refer to the following figure; the utility's first window you will see is Main Panel.

Main Panel contains features as follows:

- Display the CPU Speed, CPU external clock, Memory clock, AGP clock, and PCI clock information.
- Contains About, Voltage, Overclock, and Hardware Monitor Buttons for invoking respective panels.
- With a user-friendly Status Animation, it can represent 3 overclock percentage stages:

Man walking → overclock percentage from 100% ~ 110 %

Panther running → overclock percentage from 110% ~ 120%

Car racing → overclock percentage from 120% ~ above

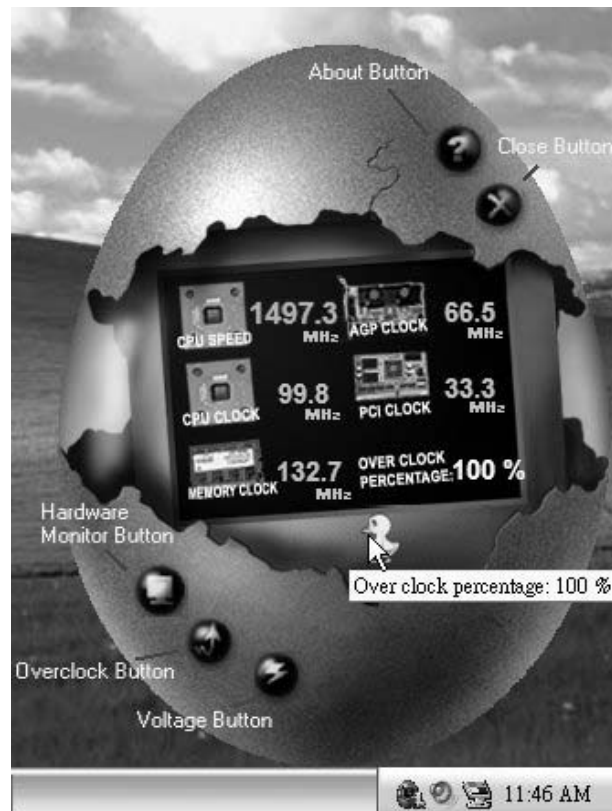

3. Voltage Panel

Click the Voltage button in Main Panel, the button will be highlighted and the Voltage Panel will slide out to up as the following figure.

In this panel, you can decide to increase CPU core voltage and Memory voltage or not. The default setting is "No". If you want to get the best performance of overclocking, we recommend you click the option "Yes".



4. Overclock Panel

Click the Overclock button in Main Panel, the button will be highlighted and the Overclock Panel will slide out to left as the following figure.



Overclock Panel contains the these features:

- a. “-3MHz button”, “-1MHz button”, “+1MHz button”, and “+3MHz button”: provide user the ability to do real-time overclock adjustment.

Warning:

Manually overclock is potentially dangerous, especially when the overclocking percentage is over 110 %. We strongly recommend you verify every speed you overclock by click the Verify button. Or, you can just click Auto overclock button and let [WarpSpeeder™] automatically gets the best result for you.

- b. “Recovery Dialog button”: Pop up the following dialog. Let user select a restoring way if system need to do a fail-safe reboot.

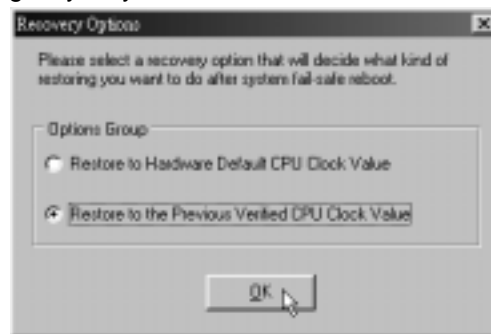

- c. “Auto-overclock button”: User can click this button and [WarpSpeeder™] will set the best and stable performance and frequency automatically. [WarpSpeeder™] utility will execute a series of testing until system fail. Then system will do fail-safe reboot by using Watchdog function. After reboot, the [WarpSpeeder™] utility will restore to the hardware default setting or load the verified best and stable frequency according to the Recovery Dialog’s setting.
- d. “Verify button”: User can click this button and [WarpSpeeder™] will proceed a testing for current frequency. If the testing is ok, then the current frequency will be saved into system registry. If the testing fail, system will do a fail-safe rebooting. After reboot, the [WarpSpeeder™] utility will restore to the hardware default setting or load the verified best and stable frequency according to the Recovery Dialog’s setting.

Note:

Because the testing programs, invoked in Auto-overclock and Verify, include DirectDraw, Direct3D and DirectShow tests, the DirectX 8.1 or newer runtime library is required. And please make sure your display card’s color depth is High color (16 bit) or True color (24/32 bit) that is required for Direct3D rendering.

5. Hardware Monitor Panel

Click the Hardware Monitor button in Main Panel, the button will be highlighted and the Hardware Monitor panel will slide out to left as the following figure.

In this panel, you can get the real-time status information of your system. The information will be refreshed every 1 second.



6. About Panel

Click the “about” button in Main Panel, the button will be highlighted and the About Panel will slide out to up as the following figure.

In this panel, you can get model name and detail information in hints of all the chipset that are related to overclocking. You can also get the mainboard’s BIOS model and the Version number of [WarpSpeeder™] utility.

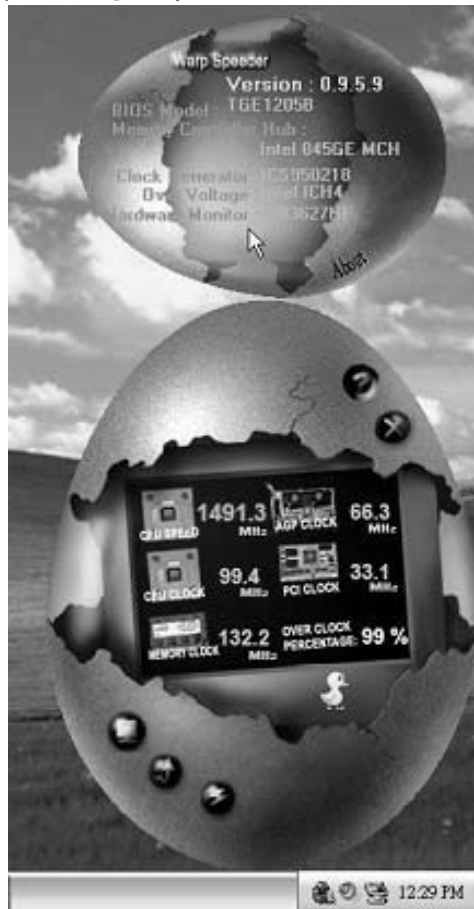

Note:

Because the overclock, overvoltage, and hardware monitor features are controlled by several separate chipset, [WarpSpeeder™] divide these features to separate panels. If one chipset is not on board, the correlative button in Main panel will be disabled, but will not interfere other panels’ functions. This property can make [WarpSpeeder™] utility more robust.

This page is intentionally left blank.

APPENDENCIES: SPEC IN OTHER LANGUAGE**GERMAN**

	<i>Ver 5.x</i>	<i>Ver 6.x</i>
CPU	Sockel 478 Intel Pentium 4 / Celeron D Prozessoren mit bis zu 3,4 GHz (Unterstützt keine Willamette CPUs) Unterstützt Hyper-Threading Technology *It is recommended to use processors with 95W power consumption.	Sockel 478 Intel Pentium 4 / Celeron D Prozessoren mit bis zu 3,4 GHz (Unterstützt keine Willamette CPUs) Unterstützt Hyper-Threading Technology *It is recommended to use processors with 95W power consumption.
FSB	400 / 533 / 800 MHz	400 / 533 / 800 MHz
Chipsatz	VIA P4M900 VIA VT8237A	VIA P4M900 VIA VT8237A
Grafik	Chrome9 HC 3D / 2D Graphics Max. 256MB gemeinsam benutzter Videospeicher	Chrome9 HC 3D / 2D Graphics Max. 256MB gemeinsam benutzter Videospeicher
Super E/A	ITE 8712F Bietet die häufig verwendeten alten Super E/A-Funktionen. Low Pin Count-Schnittstelle Umgebungskontrolle, Hardware-Überwachung Lüfterdrehzahl-Controller "Smart Guardian"-Funktion von ITE	ITE 8712F Bietet die häufig verwendeten alten Super E/A-Funktionen. Low Pin Count-Schnittstelle Umgebungskontrolle, Hardware-Überwachung Lüfterdrehzahl-Controller "Smart Guardian"-Funktion von ITE
Arbeitsspeicher	DDR2 DIMM-Steckplätze x 2 Unterstützt DDR2 533 / 667 Jeder DIMM unterstützt 256/512MB/1GB/2GB DDR2. Max. 4GB Arbeitsspeicher Ein-Kanal DDR2 Speichermodul registrierte DIMMs. ECC DIMMs werden nicht unterstützt.	DDR2 DIMM-Steckplätze x 2 Unterstützt DDR2 533 / 667 Jeder DIMM unterstützt 256/512MB/1GB/2GB DDR2. Max. 4GB Arbeitsspeicher Ein-Kanal DDR2 Speichermodul registrierte DIMMs. ECC DIMMs werden nicht unterstützt.
IDE	Integrierter IDE-Controller Ultra DMA 33 / 66 / 100 / 133 Bus Master-Modus Unterstützt PIO-Modus 0~4,	Integrierter IDE-Controller Ultra DMA 33 / 66 / 100 / 133 Bus Master-Modus Unterstützt PIO-Modus 0~4,
SATA	Integrierter Serial ATA-Controller Datentransferrate bis zu 1.5Gb/s Konform mit der SATA-Spezifikation Version 1.0.	Integrierter Serial ATA-Controller Datentransferrate bis zu 1.5Gb/s Konform mit der SATA-Spezifikation Version 1.0.

	Ver 5.x	Ver 6.x
LAN PHY	Realtek RTL 8201CL PHY 10 / 100 Mb/s Auto-Negotiation Halb-/ Vollduplex-Funktion	Realtek RTL 8201CL PHY 10 / 100 Mb/s Auto-Negotiation Halb-/ Vollduplex-Funktion
Audio-Code c	ALC883 Unterstützt High-Definition Audio 7.1-Kanal-Audioausgabe	ALC861VD Unterstützt High-Definition Audio 5.1-Kanal-Audioausgabe
Steckplätze	PCI-Steckplatz x2 PCI Express x16 Steckplatz x1 PCI Express x 1-Steckplatz x1	PCI-Steckplatz x2 PCI Express x16 Steckplatz x1 PCI Express x 1-Steckplatz x1
Onboard-An schluss	Diskettenlaufwerkanschluss x1 Druckeranschluss Anschluss x1 IDE-Anschluss x2 SATA-Anschluss x2 Fronttafelanschluss x1 Front-Audioanschluss x1 CD-IN-Anschluss x1 S/PDIF-Ausgangsanschluss x1 CPU-Lüfter-Sockel x1 System-Lüfter-Sockel x1 "CMOS löschen"-Sockel x1 USB-Anschluss x2 Stromanschluss (24-polig) x1 Stromanschluss (4-polig) x1	Diskettenlaufwerkanschluss x1 Druckeranschluss Anschluss x1 IDE-Anschluss x2 SATA-Anschluss x2 Fronttafelanschluss x1 Front-Audioanschluss x1 CD-IN-Anschluss x1 S/PDIF-Ausgangsanschluss x1 CPU-Lüfter-Sockel x1 System-Lüfter-Sockel x1 "CMOS löschen"-Sockel x1 USB-Anschluss x2 Stromanschluss (24-polig) x1 Stromanschluss (4-polig) x1
Rückseiten- E/A	PS/2-Tastatur x1 PS/2-Maus x1 Serieller Anschluss x1 VGA-Anschluss x1 LAN-Anschluss x1 USB-Anschluss x4 Audioanschluss x6	PS/2-Tastatur x1 PS/2-Maus x1 Serieller Anschluss x1 VGA-Anschluss x1 LAN-Anschluss x1 USB-Anschluss x4 Audioanschluss x3
Platinengrö ße.	190 mm (B) X 244 mm (L)	190 mm (B) X 244 mm (L)
OS-Unterstützung	Windows 2K / XP / VISTA Biostar behält sich das Recht vor, ohne Ankündigung die Unterstützung für ein Betriebssystem hinzuzufügen oder zu entfernen.	Windows 2K / XP / VISTA Biostar behält sich das Recht vor, ohne Ankündigung die Unterstützung für ein Betriebssystem hinzuzufügen oder zu entfernen.

FRANCE

	<i>Ver 5.x</i>	<i>Ver 6.x</i>
UC	Socket 478 Processeurs Intel Pentium 4 / Celeron D jusqu'à 3,4 GHz (pas de prise en charge des UC Willamette) Prend en charge les technologies Hyper-Threading *It is recommended to use processors with 95W power consumption.	Socket 478 Processeurs Intel Pentium 4 / Celeron D jusqu'à 3,4 GHz (pas de prise en charge des UC Willamette) Prend en charge les technologies Hyper-Threading *It is recommended to use processors with 95W power consumption.
Bus frontal	400 / 533 / 800 MHz	400 / 533 / 800 MHz
Chipset	VIA P4M900 VIA VT8237A	VIA P4M900 VIA VT8237A
Graphiques	Chrome9 HC 3D / 2D Graphics Mémoire vidéo partagée maximale de 256 Mo	Chrome9 HC 3D / 2D Graphics Mémoire vidéo partagée maximale de 256 Mo
Super E/S	ITE 8712F Fournit la fonctionnalité de Super E/S patrimoniales la plus utilisée. Interface à faible compte de broches Initiatives de contrôle environnementales, Moniteur de matériel Contrôleur de vitesse de ventilateur Fonction "Gardien intelligent" de l'ITE	ITE 8712F Fournit la fonctionnalité de Super E/S patrimoniales la plus utilisée. Interface à faible compte de broches Initiatives de contrôle environnementales, Moniteur de matériel Contrôleur de vitesse de ventilateur Fonction "Gardien intelligent" de l'ITE
Mémoire principale	Fentes DDR2 DIMM x 2 Prend en charge la DDR2 533 / 667 Chaque DIMM prend en charge des DDR2 de 256 Mo / 512 Mo / 1Go / 2 Go Capacité mémoire maximale de 4 Go Module de mémoire DDR2 à mode à simple voie Les DIMM à registres et DIMM avec code correcteurs d'erreurs ne sont pas prises en charge	Fentes DDR2 DIMM x 2 Prend en charge la DDR2 533 / 667 Chaque DIMM prend en charge des DDR2 de 256 Mo / 512 Mo / 1Go / 2 Go Capacité mémoire maximale de 4 Go Module de mémoire DDR2 à mode à simple voie Les DIMM à registres et DIMM avec code correcteurs d'erreurs ne sont pas prises en charge
IDE	Contrôleur IDE intégré Mode principale de Bus Ultra DMA 33 / 66 / 100 / 133 Prend en charge le mode PIO 0~4,	Contrôleur IDE intégré Mode principale de Bus Ultra DMA 33 / 66 / 100 / 133 Prend en charge le mode PIO 0~4,
SATA	Contrôleur Serial ATA intégré : Taux de transfert jusqu'à 1.5 Go/s. Conforme à la spécification SATA Version 1.0	Contrôleur Serial ATA intégré : Taux de transfert jusqu'à 1.5 Go/s. Conforme à la spécification SATA Version 1.0

		Ver 5.x	Ver 6.x
LAN PHY	Realtek RTL 8201CL PHY 10 / 100 Mb/s négociation automatique Half / Full duplex capability	Realtek RTL 8201CL PHY 10 / 100 Mb/s négociation automatique Half / Full duplex capability	Realtek RTL 8201CL PHY 10 / 100 Mb/s négociation automatique Half / Full duplex capability
Codec audio	ALC883 Prise en charge de l'audio haute définition Sortie audio à 7.1 voies	ALC861VD Prise en charge de l'audio haute définition Sortie audio à 5.1 voies	ALC861VD Prise en charge de l'audio haute définition Sortie audio à 5.1 voies
Fentes	Fente PCI x2 Slot PCI Express x16 x1 Slot PCI Express x 1 x1	Fente PCI x2 Slot PCI Express x16 x1 Slot PCI Express x 1 x1	Fente PCI x2 Slot PCI Express x16 x1 Slot PCI Express x 1 x1
Connecteur embarqué	Connecteur de disquette x1 Connecteur de Port d'imprimante x1 Connecteur IDE x2 Connecteur SATA x2 Connecteur du panneau avant x1 Connecteur Audio du panneau avant x1 Connecteur d'entrée CD x1 Connecteur de sortie S/PDIF x1 Embase de ventilateur UC x1 Embase de ventilateur système x1 Embase d'effacement CMOS x1 Connecteur USB x2 Connecteur d'alimentation x1 (24 broches) Connecteur d'alimentation x1 (4 broches)	Connecteur de disquette x1 Connecteur de Port d'imprimante x1 Connecteur IDE x2 Connecteur SATA x2 Connecteur du panneau avant x1 Connecteur Audio du panneau avant x1 Connecteur d'entrée CD x1 Connecteur de sortie S/PDIF x1 Embase de ventilateur UC x1 Embase de ventilateur système x1 Embase d'effacement CMOS x1 Connecteur USB x2 Connecteur d'alimentation x1 (24 broches) Connecteur d'alimentation x1 (4 broches)	Connecteur de disquette x1 Connecteur de Port d'imprimante x1 Connecteur IDE x2 Connecteur SATA x2 Connecteur du panneau avant x1 Connecteur Audio du panneau avant x1 Connecteur d'entrée CD x1 Connecteur de sortie S/PDIF x1 Embase de ventilateur UC x1 Embase de ventilateur système x1 Embase d'effacement CMOS x1 Connecteur USB x2 Connecteur d'alimentation x1 (24 broches) Connecteur d'alimentation x1 (4 broches)
E/S du panneau arrière	Clavier PS/2 x1 Souris PS/2 x1 Port série x1 Port VGA x1 Port LAN x1 Port USB x4 Fiche audio x6	Clavier PS/2 x1 Souris PS/2 x1 Port série x1 Port VGA x1 Port LAN x1 Port USB x4 Fiche audio x3	Clavier PS/2 x1 Souris PS/2 x1 Port série x1 Port VGA x1 Port LAN x1 Port USB x4 Fiche audio x3
Dimensions de la carte	190 mm (l) X 244 mm (H)	190 mm (l) X 244 mm (H)	190 mm (l) X 244 mm (H)
Support SE	Windows 2K / XP / VISTA Biostar se réserve le droit d'ajouter ou de supprimer le support de SE avec ou sans préavis.	Windows 2K / XP / VISTA Biostar se réserve le droit d'ajouter ou de supprimer le support de SE avec ou sans préavis.	Windows 2K / XP / VISTA Biostar se réserve le droit d'ajouter ou de supprimer le support de SE avec ou sans préavis.

ITALIAN

	<i>Ver 5.x</i>	<i>Ver 6.x</i>
CPU	Socket 478 Processore Intel Pentium 4 / Celeron D fino a 3.4 GHz (Non supporta CPU Willamette) Supporto di Hyper-Threading *It is recommended to use processors with 95W power consumption.	Socket 478 Processore Intel Pentium 4 / Celeron D fino a 3.4 GHz (Non supporta CPU Willamette) Supporto di Hyper-Threading *It is recommended to use processors with 95W power consumption.
FSB	400 / 533 / 800 MHz	400 / 533 / 800 MHz
Chipset	VIA P4M900 VIA VT8237A	VIA P4M900 VIA VT8237A
Grafica	Chrome9 HC 3D / 2D Graphics La memoria video condivisa massima è di 256MB	Chrome9 HC 3D / 2D Graphics La memoria video condivisa massima è di 256MB
Super I/O	ITE 8712F Fornisce le funzionalità legacy Super I/O usate più comunemente. Interfaccia LPC (Low Pin Count) Funzioni di controllo dell'ambiente: Monitoraggio hardware Controller velocità ventolina Funzione "Smart Guardian" di ITE	ITE 8712F Fornisce le funzionalità legacy Super I/O usate più comunemente. Interfaccia LPC (Low Pin Count) Funzioni di controllo dell'ambiente: Monitoraggio hardware Controller velocità ventolina Funzione "Smart Guardian" di ITE
Memoria principale	Alloggi DIMM DDR2 x 2 Supporto di DDR2 533 / 667 Ciascun DIMM supporta DDR2 256MB / 512MB / 1GB / 2GB Capacità massima della memoria 4GB Modulo di memoria DDR2 a canale singolo DIMM registrati e DIMM ECC non sono supportati	Alloggi DIMM DDR2 x 2 Supporto di DDR2 533 / 667 Ciascun DIMM supporta DDR2 256MB / 512MB / 1GB / 2GB Capacità massima della memoria 4GB Modulo di memoria DDR2 a canale singolo DIMM registrati e DIMM ECC non sono supportati
IDE	Controller IDE integrato Modalità Bus Master Ultra DMA 33 / 66 / 100 / 133 Supporto modalità PIO Mode 0-4	Controller IDE integrato Modalità Bus Master Ultra DMA 33 / 66 / 100 / 133 Supporto modalità PIO Mode 0-4
SATA	Controller Serial ATA integrato Velocità di trasferimento dei dati fino a 1.5 Gb/s. Compatibile specifiche SATA Versione 1.0.	Controller Serial ATA integrato Velocità di trasferimento dei dati fino a 1.5 Gb/s. Compatibile specifiche SATA Versione 1.0.
LAN PHY	Realtek RTL 8201CL PHY Negoziazione automatica 10 / 100 Mb/s Capacità Half / Full Duplex	Realtek RTL 8201CL PHY Negoziazione automatica 10 / 100 Mb/s Capacità Half / Full Duplex

		<i>Ver 5.x</i>		<i>Ver 6.x</i>		
Codec audio	ALC883			ALC861VD		
	Supporto audio High-Definition (HD) Uscita audio 7.1 canali			Supporto audio High-Definition (HD) Uscita audio 5.1 canali		
Alloggi	Alloggio PCI	x2		Alloggio PCI	x2	
	Alloggio PCI Express x16	x1		Alloggio PCI Express x16	x1	
	Alloggio PCI Express x1	x1		Alloggio PCI Express x1	x1	
Connettori su scheda	Connettore floppy	x1		Connettore floppy	x1	
	Connettore Porta stampante	x1		Connettore Porta stampante	x1	
	Connettore IDE	x2		Connettore IDE	x2	
	Connettore SATA	x2		Connettore SATA	x2	
	Connettore pannello frontale	x1		Connettore pannello frontale	x1	
	Connettore audio frontale	x1		Connettore audio frontale	x1	
	Connettore CD-in	x1		Connettore CD-in	x1	
	Connettore output SPDIF	x1		Connettore output SPDIF	x1	
	Collettore ventolina CPU	x1		Collettore ventolina CPU	x1	
	Collettore ventolina sistema	x1		Collettore ventolina sistema	x1	
	Collettore cancellazione CMOS	x1		Collettore cancellazione CMOS	x1	
	Connettore USB	x2		Connettore USB	x2	
	Connettore alimentazione (24 pin)	x1		Connettore alimentazione (24 pin)	x1	
Connettore alimentazione (4 pin)	x1		Connettore alimentazione (4 pin)	x1		
I/O pannello posteriore	Tastiera PS/2	x1		Tastiera PS/2	x1	
	Mouse PS/2	x1		Mouse PS/2	x1	
	Porta seriale	x1		Porta seriale	x1	
	Porta VGA	x1		Porta VGA	x1	
	Porta LAN	x1		Porta LAN	x1	
	Porta USB	x4		Porta USB	x4	
	Connettore audio	x6		Connettore audio	x3	
Dimensioni scheda	190 mm (larghezza) x 244 mm (altezza)		190 mm (larghezza) x 244 mm (altezza)			
Sistemi operativi supportati	Windows 2K / XP / VISTA Biostar si riserva il diritto di aggiungere o rimuovere il supporto di qualsiasi sistema operativo senza preavviso.		Windows 2K / XP / VISTA Biostar si riserva il diritto di aggiungere o rimuovere il supporto di qualsiasi sistema operativo senza preavviso.			

SPANISH

	<i>Ver 5.x</i>	<i>Ver 6.x</i>
CPU	Conector 478 Procesador Intel Pentium 4 / Celeron D hasta 3,4 GHz (no soporta CPU Willamette) Admite Hyper-Threading *It is recommended to use processors with 95W power consumption.	Conector 478 Procesador Intel Pentium 4 / Celeron D hasta 3,4 GHz (no soporta CPU Willamette) Admite Hyper-Threading *It is recommended to use processors with 95W power consumption.
FSB	400 / 533 / 800 MHz	400 / 533 / 800 MHz
Conjunto de chips	VIA P4M900 VIA VT8237A	VIA P4M900 VIA VT8237A
Gráficos	Chrome9 HC 3D / 2D Graphics Memoria máxima de vídeo compartida de 256MB	Chrome9 HC 3D / 2D Graphics Memoria máxima de vídeo compartida de 256MB
Súper E/S	ITE 8712F Le ofrece las funcionalidades heredadas de uso más común Súper E/S. Interfaz de cuenta Low Pin Iniciativas de control de entorno, Monitor hardware Controlador de velocidad de ventilador Función "Guardia inteligente" de ITE	ITE 8712F Le ofrece las funcionalidades heredadas de uso más común Súper E/S. Interfaz de cuenta Low Pin Iniciativas de control de entorno, Monitor hardware Controlador de velocidad de ventilador Función "Guardia inteligente" de ITE
Memoria principal	Ranuras DIMM DDR2 x 2 Admite DDR2 de 533 / 667 Cada DIMM admite DDR de 256MB /512MB /1GB / 2GB Capacidad máxima de memoria de 4GB Módulo de memoria DDR2 de canal Sencillo No admite DIMM registrados o DIMM compatibles con ECC	Ranuras DIMM DDR2 x 2 Admite DDR2 de 533 / 667 Cada DIMM admite DDR de 256MB /512MB /1GB / 2GB Capacidad máxima de memoria de 4GB Módulo de memoria DDR2 de canal Sencillo No admite DIMM registrados o DIMM compatibles con ECC
IDE	Controlador IDE integrado Modo bus maestro Ultra DMA 33 / 66 / 100 / 133 Soporte los Modos PIO 0~4,	Controlador IDE integrado Modo bus maestro Ultra DMA 33 / 66 / 100 / 133 Soporte los Modos PIO 0~4,
SATA	Controlador ATA Serie Integrado Tasas de transferencia de hasta 1.5 Gb/s. Compatible con la versión SATA 1.0.	Controlador ATA Serie Integrado Tasas de transferencia de hasta 1.5 Gb/s. Compatible con la versión SATA 1.0.
Red Local	Realtek RTL 8201CL PHY Negociación de 10 / 100 Mb/s Funciones Half / Full dúplex	Realtek RTL 8201CL PHY Negociación de 10 / 100 Mb/s Funciones Half / Full dúplex

	<i>Ver 5.x</i>		<i>Ver 6.x</i>	
Códecs de sonido	ALC883 Soporte de sonido de Alta Definición Salida de sonido de 7.1 canales		ALC861VD Soporte de sonido de Alta Definición Salida de sonido de 5.1 canales	
Ranuras	Ranura PCI X2		Ranura PCI X2	
	Ranura PCI Express x16 X1		Ranura PCI Express x16 X1	
	Ranura PCI express x 1 X1		Ranura PCI express x 1 X1	
Conectores en placa	Conector disco flexible X1		Conector disco flexible X1	
	Conector Puerto de impresora X1		Conector Puerto de impresora X1	
	Conector IDE X2		Conector IDE X2	
	Conector SATA X2		Conector SATA X2	
	Conector de panel frontal X1		Conector de panel frontal X1	
	Conector de sonido frontal X1		Conector de sonido frontal X1	
	Conector de entrada de CD X1		Conector de entrada de CD X1	
	Conector de salida S/PDIF X1		Conector de salida S/PDIF X1	
	Cabecera de ventilador de CPU X1		Cabecera de ventilador de CPU X1	
	Cabecera de ventilador de sistema X1		Cabecera de ventilador de sistema X1	
	Cabecera de borrado de CMOS X1		Cabecera de borrado de CMOS X1	
	Conector USB X2		Conector USB X2	
	Conector de alimentación (24 patillas) X1		Conector de alimentación (24 patillas) X1	
	Conector de alimentación (4 patillas) X1		Conector de alimentación (4 patillas) X1	
Panel trasero de E/S	Teclado PS/2 X1		Teclado PS/2 X1	
	Ratón PS/2 X1		Ratón PS/2 X1	
	Puerto serie X1		Puerto serie X1	
	Puerto VGA X1		Puerto VGA X1	
	Puerto de red local X1		Puerto de red local X1	
	Puerto USB X4		Puerto USB X4	
	Conector de sonido X6		Conector de sonido X3	
Tamaño de la placa	190mm. (A) X 244 Mm. (H)		190mm. (A) X 244 Mm. (H)	
Soporte de sistema operativo	Windows 2K / XP / VISTA Biostar se reserva el derecho de añadir o retirar el soporte de cualquier SO con o sin aviso previo.		Windows 2K / XP / VISTA Biostar se reserva el derecho de añadir o retirar el soporte de cualquier SO con o sin aviso previo.	

PORTUGUESE

	<i>Ver 5.x</i>	<i>Ver 6.x</i>
CPU	Socket 478 Processador Intel Pentium 4 / Celeron D até 3,4 GHz (não suporta a CPU Willamette) Suporta as tecnologias Hyper-Threading *It is recommended to use processors with 95W power consumption.	Socket 478 Processador Intel Pentium 4 / Celeron D até 3,4 GHz (não suporta a CPU Willamette) Suporta as tecnologias Hyper-Threading *It is recommended to use processors with 95W power consumption.
FSB	400 / 533 / 800 MHz	400 / 533 / 800 MHz
Chipset	VIA P4M900 VIA VT8237A	VIA P4M900 VIA VT8237A
Placa gráfica	Chrome9 HC 3D / 2D Graphics Memória de vídeo máxima partilhada: 256 MB	Chrome9 HC 3D / 2D Graphics Memória de vídeo máxima partilhada: 256 MB
Especificação Super I/O	ITE 8712F Proporciona as funcionalidades mais utilizadas em termos da especificação Super I/O. Interface LPC (Low Pin Count). Iniciativas para controlo do ambiente Monitorização do hardware Controlador da velocidade da ventoinha Função "Smart Guardian" da ITE	ITE 8712F Proporciona as funcionalidades mais utilizadas em termos da especificação Super I/O. Interface LPC (Low Pin Count). Iniciativas para controlo do ambiente Monitorização do hardware Controlador da velocidade da ventoinha Função "Smart Guardian" da ITE
Memória principal	Ranuras DIMM DDR2 x 2 Suporta módulos DDR2 533 / 667 Cada módulo DIMM suporta uma memória DDR2 de 256MB / 512 MB / 1 GB / 2GB Capacidade máxima de memória: 4 GB Módulo de memória DDR2 de canal simples Os módulos DIMM registados e os DIMM ECC não são suportados	Ranuras DIMM DDR2 x 2 Suporta módulos DDR2 533 / 667 Cada módulo DIMM suporta uma memória DDR2 de 256MB / 512 MB / 1 GB / 2GB Capacidade máxima de memória: 4 GB Módulo de memória DDR2 de canal simples Os módulos DIMM registados e os DIMM ECC não são suportados
IDE	Controlador IDE integrado Modo Bus master Ultra DMA 33 / 66 / 100 / 133 Suporta o modo PIO 0~4,	Controlador IDE integrado Modo Bus master Ultra DMA 33 / 66 / 100 / 133 Suporta o modo PIO 0~4,
SATA	Controlador Serial ATA integrado Velocidades de transmissão de dados até 1.5 Gb/s. Compatibilidade com a especificação SATA versão 1.0.	Controlador Serial ATA integrado Velocidades de transmissão de dados até 1.5 Gb/s. Compatibilidade com a especificação SATA versão 1.0.
LAN PHY	Realtek RTL 8201CL PHY Auto negociação de 10 / 100 MB/s Capacidade semi/full-duplex	Realtek RTL 8201CL PHY Auto negociação de 10 / 100 MB/s Capacidade semi/full-duplex

	<i>Ver 5.x</i>	<i>Ver 6.x</i>
Codec de som	ALC883 Suporta a especificação High-Definition Audio Saída de áudio de 7.1 canais	ALC861VD Suporta a especificação High-Definition Audio Saída de áudio de 5.1 canais
Ranhuradas	Ranhura PCI x2 Ranhura PCI Express x16 x1 Ranhura PCI Express x 1 x1	Ranhura PCI x2 Ranhura PCI Express x16 x1 Ranhura PCI Express x 1 x1
Conectores na placa	Conector da unidade de disquetes x1 Conector da para impressora x1 Conector IDE x2 Conector SATA x2 Conector do painel frontal x1 Conector de áudio frontal x1 Conector para entrada de CDs x1 Conector de saída S/PDIF x1 Conector da ventoinha da CPU x1 Conector da ventoinha do sistema x1 Conector para limpeza do CMOS x1 Conector USB x2 Conector de alimentação (24 pinos) x1 Conector de alimentação (4 pinos) x1	Conector da unidade de disquetes x1 Conector da para impressora x1 Conector IDE x2 Conector SATA x2 Conector do painel frontal x1 Conector de áudio frontal x1 Conector para entrada de CDs x1 Conector de saída S/PDIF x1 Conector da ventoinha da CPU x1 Conector da ventoinha do sistema x1 Conector para limpeza do CMOS x1 Conector USB x2 Conector de alimentação (24 pinos) x1 Conector de alimentação (4 pinos) x1
Entradas/Saídas no painel traseiro	Teclado PS/2 x1 Rato PS/2 x1 Porta série x1 Porta VGA x1 Porta LAN x1 Porta USB x4 Tomada de áudio x6	Teclado PS/2 x1 Rato PS/2 x1 Porta série x1 Porta VGA x1 Porta LAN x1 Porta USB x4 Tomada de áudio x3
Tamanho da placa	190 mm (L) X 244 mm (A)	190 mm (L) X 244 mm (A)
Sistemas operativos suportados	Windows 2K / XP / VISTA A Biostar reserva-se o direito de adicionar ou remover suporte para qualquer sistema operativo com ou sem aviso prévio.	Windows 2K / XP / VISTA A Biostar reserva-se o direito de adicionar ou remover suporte para qualquer sistema operativo com ou sem aviso prévio.

POLISH

	<i>Ver 5.x</i>	<i>Ver 6.x</i>
Procesor	Socket 478 Procesor Intel Pentium 4 / Celeron D do 3,4 GHz (brak obsługi procesorów Willamette) Obsługa Hyper-Threading Technology *It is recommended to use processors with 95W power consumption.	Socket 478 Procesor Intel Pentium 4 / Celeron D do 3,4 GHz (brak obsługi procesorów Willamette) Obsługa Hyper-Threading Technology *It is recommended to use processors with 95W power consumption.
FSB	400 / 533 / 800 MHz	400 / 533 / 800 MHz
Chipset	VIA P4M900 VIA VT8237A	VIA P4M900 VIA VT8237A
Grafika	Chrome9 HC 3D / 2D Graphics Maks. wielkość współdzielonej pamięci video wynosi 256MB	Chrome9 HC 3D / 2D Graphics Maks. wielkość współdzielonej pamięci video wynosi 256MB
Pamięć główna	Gniazda DDR2 DIMM x 2 Obsługa DDR2 533 / 667 Każde gniazdo DIMM obsługuje moduły 256MB / 512MB / 1GB / 2GB DDR2 Maks. wielkość pamięci 4GB Moduł pamięci DDR2 z trybem pojedynczego kanału Brak obsługi Registered DIMM oraz ECC DIMM	Gniazda DDR2 DIMM x 2 Obsługa DDR2 533 / 667 Każde gniazdo DIMM obsługuje moduły 256MB / 512MB / 1GB / 2GB DDR2 Maks. wielkość pamięci 4GB Moduł pamięci DDR2 z trybem pojedynczego kanału Brak obsługi Registered DIMM oraz ECC DIMM
Super I/O	ITE 8712F Zapewnia najbardziej powszechne funkcje Super I/O. Interfejs Low Pin Count Funkcje kontroli warunków pracy, Monitor H/W Kontroler prędkości wentylatora Funkcja ITE "Smart Guardian "	ITE 8712F Zapewnia najbardziej powszechne funkcje Super I/O. Interfejs Low Pin Count Funkcje kontroli warunków pracy, Monitor H/W Kontroler prędkości wentylatora Funkcja ITE "Smart Guardian "
IDE	Zintegrowany kontroler IDE Ultra DMA 33 / 66 / 100 / 133 Tryb Bus Master obsługa PIO tryb 0~4,	Zintegrowany kontroler IDE Ultra DMA 33 / 66 / 100 / 133 Tryb Bus Master obsługa PIO tryb 0~4,
SATA	Zintegrowany kontroler Serial ATA Transfer danych do 1.5 Gb/s. Zgodność ze specyfikacją SATA w wersji 1.0.	Zintegrowany kontroler Serial ATA Transfer danych do 1.5 Gb/s. Zgodność ze specyfikacją SATA w wersji 1.0.

		Ver 5.x	Ver 6.x
LAN PHY	Realtek RTL 8201CL PHY 10 / 100 Mb/s z automatyczną negocjacją szybkości Działanie w trybie połówicznego / pełnego dupleksu	Realtek RTL 8201CL PHY 10 / 100 Mb/s z automatyczną negocjacją szybkości Działanie w trybie połówicznego / pełnego dupleksu	Realtek RTL 8201CL PHY 10 / 100 Mb/s z automatyczną negocjacją szybkości Działanie w trybie połówicznego / pełnego dupleksu
Kodek dźwiękowy	ALC883 Obsługa High-Definition Audio 7.1 kanałowe wyjście audio	ALC861VD Obsługa High-Definition Audio 5.1 kanałowe wyjście audio	ALC861VD Obsługa High-Definition Audio 5.1 kanałowe wyjście audio
Gniazda	Gniazdo PCI x2 Gniazdo PCI Express x16 x1 Gniazdo PCI Express x 1 x1	Gniazdo PCI x2 Gniazdo PCI Express x16 x1 Gniazdo PCI Express x 1 x1	Gniazdo PCI x2 Gniazdo PCI Express x16 x1 Gniazdo PCI Express x 1 x1
Złącza wbudowan e	Złącze napędu dyskietek x1 Złącze Port drukarki x1 Złącze IDE x2 Złącze SATA x2 Złącze panela przedniego x1 Przednie złącze audio x1 Złącze wejścia CD x1 Złącze wyjścia S/PDIF x1 Złącze główkowe wentylatora procesora x1 Złącze główkowe wentylatora systemowego x1 Złącze główkowe kasowania CMOS x1 Złącze USB x2 Złącze zasilania (24 pinowe) x1 Złącze zasilania (4 pinowe) x1	Złącze napędu dyskietek x1 Złącze Port drukarki x1 Złącze IDE x2 Złącze SATA x2 Złącze panela przedniego x1 Przednie złącze audio x1 Złącze wejścia CD x1 Złącze wyjścia S/PDIF x1 Złącze główkowe wentylatora procesora x1 Złącze główkowe wentylatora systemowego x1 Złącze główkowe kasowania CMOS x1 Złącze USB x2 Złącze zasilania (24 pinowe) x1 Złącze zasilania (4 pinowe) x1	Złącze napędu dyskietek x1 Złącze Port drukarki x1 Złącze IDE x2 Złącze SATA x2 Złącze panela przedniego x1 Przednie złącze audio x1 Złącze wejścia CD x1 Złącze wyjścia S/PDIF x1 Złącze główkowe wentylatora procesora x1 Złącze główkowe wentylatora systemowego x1 Złącze główkowe kasowania CMOS x1 Złącze USB x2 Złącze zasilania (24 pinowe) x1 Złącze zasilania (4 pinowe) x1
Back Panel I/O	Klawiatura PS/2 x1 Mysz PS/2 x1 Port szeregowy x1 Port VGA x1 Port LAN x1 Port USB x4 Gniazdo audio x6	Klawiatura PS/2 x1 Mysz PS/2 x1 Port szeregowy x1 Port VGA x1 Port LAN x1 Port USB x4 Gniazdo audio x3	Klawiatura PS/2 x1 Mysz PS/2 x1 Port szeregowy x1 Port VGA x1 Port LAN x1 Port USB x4 Gniazdo audio x3
Wymiary płyty	190 mm (S) X 244 mm (W)	190 mm (S) X 244 mm (W)	190 mm (S) X 244 mm (W)
Obsługa systemu operacyjn ego	Windows 2K / XP / VISTA Biostar zastrzega sobie prawo dodawania lub odwoływania obsługi dowolnego systemu operacyjnego bez powiadomienia.	Windows 2K / XP / VISTA Biostar zastrzega sobie prawo dodawania lub odwoływania obsługi dowolnego systemu operacyjnego bez powiadomienia.	Windows 2K / XP / VISTA Biostar zastrzega sobie prawo dodawania lub odwoływania obsługi dowolnego systemu operacyjnego bez powiadomienia.

RUSSIAN

	<i>Ver 5.x</i>	<i>Ver 6.x</i>
СРU (центральный процессор)	Гнездо 478 Процессор Intel Pentium 4 / Celeron D до 3.4 ГГц (не поддерживает центральные процессоры Willamette) Поддержка технологий Hyper-Threading Technology *It is recommended to use processors with 95W power consumption.	Гнездо 478 Процессор Intel Pentium 4 / Celeron D до 3.4 ГГц (не поддерживает центральные процессоры Willamette) Поддержка технологий Hyper-Threading Technology *It is recommended to use processors with 95W power consumption.
FSB	400 / 533 / 800 МГц	400 / 533 / 800 МГц
Набор микросхем	VIA P4M900 VIA VT8237A	VIA P4M900 VIA VT8237A
Графика	Chrome9 HC 3D / 2D Graphics Максимальная совместно используемая видео память составляет 256 МБ	Chrome9 HC 3D / 2D Graphics Максимальная совместно используемая видео память составляет 256 МБ
Основная память	Слоты DDR2 DIMM x 2 Поддержка DDR2 533 / 667 Каждый модуль DIMM поддерживает 256МБ / 512МБ / 1ГБ / 2ГБ DDR2 Максимальная ёмкость памяти 4 ГБ Модуль памяти с одноканальным режимом DDR2 Не поддерживает зарегистрированные модули DIMM and ECC DIMM	Слоты DDR2 DIMM x 2 Поддержка DDR2 533 / 667 Каждый модуль DIMM поддерживает 256МБ / 512МБ / 1ГБ / 2ГБ DDR2 Максимальная ёмкость памяти 4 ГБ Модуль памяти с одноканальным режимом DDR2 Не поддерживает зарегистрированные модули DIMM and ECC DIMM
Super I/O	ITE 8712F Обеспечивает наиболее используемые действующие функциональные возможности Super I/O. Интерфейс с низким количеством выводов Инициативы по охране окружающей среды, Аппаратный монитор Регулятор скорости Функция ITE "Smart Guardian" (Интеллектуальная защита)	ITE 8712F Обеспечивает наиболее используемые действующие функциональные возможности Super I/O. Интерфейс с низким количеством выводов Инициативы по охране окружающей среды, Аппаратный монитор Регулятор скорости Функция ITE "Smart Guardian" (Интеллектуальная защита)
IDE	Встроенное устройство управления встроенными интерфейсами устройств Режим "хозяина" шины Ultra DMA 33 / 66 / 100 / 133 Поддержка режима PIO 0~4,	Встроенное устройство управления встроенными интерфейсами устройств Режим "хозяина" шины Ultra DMA 33 / 66 / 100 / 133 Поддержка режима PIO 0~4,
SATA	Встроенное последовательное устройство управления ATA скорость передачи данных до 1.5 гигабит/с. Соответствие спецификации SATA версия 1.0.	Встроенное последовательное устройство управления ATA скорость передачи данных до 1.5 гигабит/с. Соответствие спецификации SATA версия 1.0.

	Ver 5.x	Ver 6.x
Локальная сеть	Realtek RTL 8201CL PHY Автоматическое согласование 10 / 100 Мб/с Частичная / полная дуплексная способность	Realtek RTL 8201CL PHY Автоматическое согласование 10 / 100 Мб/с Частичная / полная дуплексная способность
Звуковой кодек	ALC883 Звуковая поддержка High-Definition 7.1канальный звуковой выход	ALC861VD Звуковая поддержка High-Definition 5.1канальный звуковой выход
Слоты	Слот PCI x2 Слот PCI Express x16 x1 Слот PCI Express x 1 x1	Слот PCI x2 Слот PCI Express x16 x1 Слот PCI Express x 1 x1
Встроенный разъём	Разъём НГМД x1 Разъём Порт подключения принтера x1 Разъём IDE x2 Разъём SATA x2 Разъём на лицевой панели x1 Входной звуковой разъём x1 Разъём ввода для CD x1 Разъём вывода для S/PDIF x1 Контактирующее приспособление вентилятора центрального процессора x1 Контактирующее приспособление вентилятора системы x1 Открытое контактирующее приспособление CMOS x1 USB-разъём x2 Разъем питания (24 вывод) x1 Разъем питания (4 вывод) x1	Разъём НГМД x1 Разъём Порт подключения принтера x1 Разъём IDE x2 Разъём SATA x2 Разъём на лицевой панели x1 Входной звуковой разъём x1 Разъём ввода для CD x1 Разъём вывода для S/PDIF x1 Контактирующее приспособление вентилятора центрального процессора x1 Контактирующее приспособление вентилятора системы x1 Открытое контактирующее приспособление CMOS x1 USB-разъём x2 Разъем питания (24 вывод) x1 Разъем питания (4 вывод) x1
Задняя панель средств ввода-вывода	Клавиатура PS/2 x1 Мышь PS/2 x1 Последовательный порт x1 Порт VGA x1 Порт LAN x1 USB-порт x4 Гнездо для подключения наушников x6	Клавиатура PS/2 x1 Мышь PS/2 x1 Последовательный порт x1 Порт VGA x1 Порт LAN x1 USB-порт x4 Гнездо для подключения наушников x3
Размер панели	190 мм (Ш) X 244 мм (В)	190 мм (Ш) X 244 мм (В)
Поддержка OS	Windows 2K / XP / VISTA Biostar сохраняет за собой право добавлять или удалять средства обеспечения для OS с или без предварительного уведомления.	Windows 2K / XP / VISTA Biostar сохраняет за собой право добавлять или удалять средства обеспечения для OS с или без предварительного уведомления.

ARABIC

Ver 6.x	Ver 5.x	
478مقيس بتردد يصل Intel Pentium 4 / Celeron D معالجات إلى 3.4 جيجا هرتز Willamette لا تدعم وحدة المعالجة المركزية Hyper-Threading Technology تدعم تقنيات *It is recommended to use processors with 95W power consumption.	478مقيس بتردد يصل Intel Pentium 4 / Celeron D معالجات إلى 3.4 جيجا هرتز Willamette لا تدعم وحدة المعالجة المركزية Hyper-Threading Technology تدعم تقنيات *It is recommended to use processors with 95W power consumption.	وحدة المعالجة المركزية
ميغا هرتز 400 / 533 / 800 تردد	ميغا هرتز 400 / 533 / 800 تردد	الناقل الأمامي الجانبية
VIA P4M900 VIA VT8237A	VIA P4M900 VIA VT8237A	مجموعة الشرائح
Chrome9 HC 3D / 2D Graphics ميغا بايت 256 أقصى سعة لذاكرة الفيديو المشتركة	Chrome9 HC 3D / 2D Graphics ميغا بايت 256 أقصى سعة لذاكرة الفيديو المشتركة	بطاقة الرسومات
عدد 2 قناة DDR2 DIMM ميغا بايت 533 / 667 سعات DDR2 تدعم الذاكرة من نوع سعة DDR2 تدعم ذاكرة من نوع DIMM تدعم كل قناة ميغا بايت و 1 جيجا بايت / 2 جيجا بايت / 512 / ميغا بايت 256 بايت سعة ذاكرة قصوى 4 جيجا بايت أحادية القناة DDR2 وحدة ذاكرة المسجلة وتلك التي لا تتوافق مع DIMM لا تدعم رقائق الذاكرة ECC	عدد 2 قناة DDR2 DIMM ميغا بايت 533 / 667 سعات DDR2 تدعم الذاكرة من نوع سعة DDR2 تدعم ذاكرة من نوع DIMM تدعم كل قناة ميغا بايت و 1 جيجا بايت / 2 جيجا بايت / 512 / ميغا بايت 256 بايت سعة ذاكرة قصوى 4 جيجا بايت أحادية القناة DDR2 وحدة ذاكرة المسجلة وتلك التي لا تتوافق مع DIMM لا تدعم رقائق الذاكرة ECC	الذاكرة الرئيسية
ITE 8712F الأكثر استخداماً، Super I/O يوفر وظيفة Low Pin Count Interface تدعم تقنية وسائل التحكم في البيئة: مراقب لمعرفة حالة الأجهزة مراقب في سرعة المروحة من ITE "Smart Guardian" وظيفة	ITE 8712F الأكثر استخداماً، Super I/O يوفر وظيفة Low Pin Count Interface تدعم تقنية وسائل التحكم في البيئة: مراقب لمعرفة حالة الأجهزة مراقب في سرعة المروحة من ITE "Smart Guardian" وظيفة	Super I/O
متكامل IDE متحكم Ultra DMA 33 / 66 / 100 / 133 ناقل بتقنية وضع رئيسي PIO Mode 0~4 دعم وضع	متكامل IDE متحكم Ultra DMA 33 / 66 / 100 / 133 ناقل بتقنية وضع رئيسي PIO Mode 0~4 دعم وضع	منفذ IDE
متكامل Serial ATA متحكم نقل البيانات بسرعات تصل إلى 1.5 جيجابت/ثانية. 1.0 الإصدار SATA مطابقة لمواصفات	متكامل Serial ATA متحكم نقل البيانات بسرعات تصل إلى 1.5 جيجابت/ثانية. 1.0 الإصدار SATA مطابقة لمواصفات	SATA

P4M900-M4

Ver 6.x	Ver 5.x	
Realtek RTL 8201CL PHY تفاوض تلقائي 100/10 ميجا بايت / ثانية إمكانية النقل المزدوج الكامل/النصفي	Realtek RTL 8201CL PHY تفاوض تلقائي 100/10 ميجا بايت / ثانية إمكانية النقل المزدوج الكامل/النصفي	شبكة داخلية
ALC861VD تدعم تقنية الصوت عالي التعريف من 5.1 قنوات لخرج الصوت	ALC883 تدعم تقنية الصوت عالي التعريف من 7.1 قنوات لخرج الصوت	كوديك الصوت
عدد 2 فتحة PCI عدد 1 فتحة PCI Express x16 عدد 1 فتحة PCI Express x1	عدد 2 فتحة PCI عدد 1 فتحة PCI Express x16 عدد 1 فتحة PCI Express x1	الفتحات
عدد 1 منفذ محرك أقراص مرنة عدد 1 منفذ طباعة عدد 2 منفذ IDE عدد 2 منفذ SATA عدد 1 منفذ اللوحة الأملية عدد 1 منفذ الصوت الأملي عدد 1 منفذ CD-IN عدد 1 منفذ خرج S/PDIF عدد 1 وصلة مروحة وحدة المعالجة المركزية عدد 1 وصلة مروحة النظام عدد 1 وصلة مسح CMOS عدد 2 منفذ USB عدد 1 منفذ توصيل الطاقة (24بيوس) عدد 1 منفذ توصيل الطاقة (4دبابيس)	عدد 1 منفذ محرك أقراص مرنة عدد 1 منفذ طباعة عدد 2 منفذ IDE عدد 2 منفذ SATA عدد 1 منفذ اللوحة الأملية عدد 1 منفذ الصوت الأملي عدد 1 منفذ CD-IN عدد 1 منفذ خرج S/PDIF عدد 1 وصلة مروحة وحدة المعالجة المركزية عدد 1 وصلة مروحة النظام عدد 1 وصلة مسح CMOS عدد 2 منفذ USB عدد 1 منفذ توصيل الطاقة (24بيوس) عدد 1 منفذ توصيل الطاقة (4دبابيس)	المنافذ على سطح اللوحة
عدد 1 لوحة مفاتيح PS/2 عدد 1 ملوس PS/2 عدد 1 منفذ تسلسلي عدد 1 منفذ VGA عدد 1 منفذ شبكة اتصال محلية عدد 4 منافذ USB عدد 3 مقيس صوت	عدد 1 لوحة مفاتيح PS/2 عدد 1 ملوس PS/2 عدد 1 منفذ تسلسلي عدد 1 منفذ VGA عدد 1 منفذ شبكة اتصال محلية عدد 4 منافذ USB عدد 6 مقيس صوت	منافذ دخل/خرج اللوحة الخلفية
190 مم (عرض) X 244 مم (ارتفاع)	190 مم (عرض) X 244 مم (ارتفاع)	حجم اللوحة
Windows 2K / XP / VISTA بحقها في إضافة أو إزالة الدعم لأي نظام Biostar تحتفظ تشغيل بإخطار أو بدون إخطار .	Windows 2K / XP / VISTA بحقها في إضافة أو إزالة الدعم لأي نظام Biostar تحتفظ تشغيل بإخطار أو بدون إخطار .	دعم أنظمة التشغيل

JAPANESE

	Ver 5.x	Ver 6.x
CPU	Socket 478 Intel Pentium 4 / Celeron D processor up to 3.4 GHz (Willamette CPUはサポートしません) Hyper-Threading Technology をサポートします *It is recommended to use processors with 95W power consumption.	Socket 478 Intel Pentium 4 / Celeron D processor up to 3.4 GHz (Willamette CPUはサポートしません) Hyper-Threading Technology をサポートします *It is recommended to use processors with 95W power consumption.
FSB	400 / 533 / 800 MHz	400 / 533 / 800 MHz
チップセット	VIA P4M900 VIA VT8237A	VIA P4M900 VIA VT8237A
グラフィックス	Chrome9 HC 3D / 2D Graphics 最大の共有ビデオメモリは256MBです	Chrome9 HC 3D / 2D Graphics 最大の共有ビデオメモリは256MBです
メインメモリ	DDR2 DIMMスロット × 2 DDR2 533 / 667をサポート 各DIMMは 256/512MB/1GB/2GB DDR2をサポート 最大メモリ容量4GB シングル チャンネルモードDDR2メモリモジュール 登録済みDIMMとECC DIMMはサポートされません	DDR2 DIMMスロット × 2 DDR2 533 / 667をサポート 各DIMMは 256/512MB/1GB/2GB DDR2をサポート 最大メモリ容量4GB シングル チャンネルモードDDR2メモリモジュール 登録済みDIMMとECC DIMMはサポートされません
Super I/O	ITE 8712F もつとも一般に使用されるレガシーSuper I/O機能を採用しています。 低ピンカウントインターフェイス 環境コントロールイニシアチブ、 H/Wモニター ファン速度コントローラ/ モニター ITEの「スマートガーディアン」機能	ITE 8712F もつとも一般に使用されるレガシーSuper I/O機能を採用しています。 低ピンカウントインターフェイス 環境コントロールイニシアチブ、 H/Wモニター ファン速度コントローラ/ モニター ITEの「スマートガーディアン」機能
IDE	統合IDEコントローラ Ultra DMA 33 / 66 / 100 / 133バスマスタモード PIO Mode 0~4のサポート、	統合IDEコントローラ Ultra DMA 33 / 66 / 100 / 133バスマスタモード PIO Mode 0~4のサポート、
SATA	統合シリアルATAコントローラ 最高1.5 Gb/秒のデータ転送速度 SATAバージョン1.0仕様に準拠。	統合シリアルATAコントローラ 最高1.5 Gb/秒のデータ転送速度 SATAバージョン1.0仕様に準拠。

		Ver 5.x	Ver 6.x
LAN PHY	Realtek RTL 8201CL PHY 10 / 100 Mb/秒のオートネゴシエーション 半/全二重機能	Realtek RTL 8201CL PHY 10 / 100 Mb/秒のオートネゴシエーション 半/全二重機能	Realtek RTL 8201CL PHY 10 / 100 Mb/秒のオートネゴシエーション 半/全二重機能
サウンド Codec	ALC883 ハイデフィニションオーディオのサポート 7.1 チャンネルオーディオアウト	ALC861VD ハイデフィニションオーディオのサポート 5.1 チャンネルオーディオアウト	ALC861VD ハイデフィニションオーディオのサポート 5.1 チャンネルオーディオアウト
スロット	PCIスロット	x2	PCIスロット x2
	PCI Express x16スロット	x1	PCI Express x16スロット x1
	PCI Express x 1スロット	x1	PCI Express x 1スロット x1
オンボード コネクタ	フロッピーコネクタ	x1	フロッピーコネクタ x1
	プリンタポートコネクタ	x1	プリンタポートコネクタ x1
	IDEコネクタ	x2	IDEコネクタ x2
	SATAコネクタ	x2	SATAコネクタ x2
	フロントパネルコネクタ	x1	フロントパネルコネクタ x1
	フロントオーディオコネクタ	x1	フロントオーディオコネクタ x1
	CDインコネクタ	x1	CDインコネクタ x1
	S/PDIFアウトコネクタ	x1	S/PDIFアウトコネクタ x1
	CPUファンヘッダ	x1	CPUファンヘッダ x1
	システムファンヘッダ	x1	システムファンヘッダ x1
	CMOSクリアヘッダ	x1	CMOSクリアヘッダ x1
	USBコネクタ	x2	USBコネクタ x2
	電源コネクタ(24ピン)	x1	電源コネクタ(24ピン) x1
電源コネクタ(4ピン)	x1	電源コネクタ(4ピン) x1	
背面パネル I/O	PS/2キーボード	x1	PS/2キーボード x1
	PS/2マウス	x1	PS/2マウス x1
	シリアルポート	x1	シリアルポート x1
	VGAポート	x1	VGAポート x1
	LANポート	x1	LANポート x1
	USBポート	x4	USBポート x4
	オーディオジャック	x6	オーディオジャック x3
ボードサイズ	190 mm (幅) X 244 mm (高さ)	190 mm (幅) X 244 mm (高さ)	190 mm (幅) X 244 mm (高さ)
OSサポ ート	Windows 2K / XP / VISTA Biostarは事前のサポートなしにOSサポートを 追加または削除する権利を留保します。	Windows 2K / XP / VISTA Biostarは事前のサポートなしにOSサポートを 追加または削除する権利を留保します。	Windows 2K / XP / VISTA Biostarは事前のサポートなしにOSサポートを 追加または削除する権利を留保します。

2007/04/20