

FCC Information and Copyright

This equipment has been tested and found to comply with the limits of a Class B digital device, pursuant to Part 15 of the FCC Rules. These limits are designed to provide reasonable protection against harmful interference in a residential installation. This equipment generates, uses, and can radiate radio frequency energy and, if not installed and used in accordance with the instructions, may cause harmful interference to radio communications. There is no guarantee that interference will not occur in a particular installation.

The vendor makes no representations or warranties with respect to the contents here and specially disclaims any implied warranties of merchantability or fitness for any purpose. Further the vendor reserves the right to revise this publication and to make changes to the contents here without obligation to notify any party beforehand.

Duplication of this publication, in part or in whole, is not allowed without first obtaining the vendor's approval in writing.

The content of this user's manual is subject to be changed without notice and we will not be responsible for any mistakes found in this user's manual. All the brand and product names are trademarks of their respective companies.



Dichiarazione di conformità sintetica

Ai sensi dell'art. 2 comma 3 del D.M. 275 del 30/10/2002

Si dichiara che questo prodotto è conforme alle normative vigenti e soddisfa i requisiti essenziali richiesti dalle direttive

2004/108/CE, 2006/95/CE e 1999/05/CE

quando ad esso applicabili

Short Declaration of conformity

We declare this product is complying with the laws in force and meeting all the essential requirements as specified by the directives

2004/108/CE, 2006/95/CE and 1999/05/CE

whenever these laws may be applied

Table of Contents

Chapter 1: Introduction	3
1.1 Before You Start	3
1.2 Package Checklist	3
1.3 Motherboard Specifications	4
1.4 Rear Panel Connectors	5
1.5 Motherboard Layout.....	6
Chapter 2: Hardware Installation	7
2.1 Install Central Processing Unit (CPU).....	7
2.2 Install a Heatsink	8
2.3 Connect Cooling Fans	9
2.4 Installing System Memory.....	10
2.5 Expansion Slots.....	12
2.6 Jumper Setting	13
2.7 Headers & Connectors	14
Chapter 3: BIOS & Software	18
3.1 BIOS Setup	18
3.2 BIOS Update.....	18
3.3 Software.....	23
Chapter 4: Useful Help	26
4.1 Driver Installation.....	26
4.2 Troubleshooting.....	27
4.3 RAID Functions	29
Appendix: Specifications In Other Languages	32
German	32
French	34
Italian	36
Spanish.....	38
Portuguese	40
Polish	42
Russian	44
Arabic.....	46
Japanese.....	48

CHAPTER 1: INTRODUCTION

1.1 Before You Start

Thank you for choosing our product. Before you start installing the motherboard, please make sure you follow the instructions below:

- Prepare a dry and stable working environment with sufficient lighting.
- Always disconnect the computer from power outlet before operation.
- Before you take the motherboard out from anti-static bag, ground yourself properly by touching any safely grounded appliance, or use grounded wrist strap to remove the static charge.
- Avoid touching the components on motherboard or the rear side of the board unless necessary. Hold the board on the edge, do not try to bend or flex the board.
- Do not leave any unfastened small parts inside the case after installation. Loose parts will cause short circuits which may damage the equipment.
- Keep the computer from dangerous area, such as heat source, humid air and water.
- The operating temperatures of the computer should be 0 to 45 degrees Celsius.
- To avoid injury, be careful of:
 - Sharp pins on headers and connectors
 - Rough edges and sharp corners on the chassis
 - Damage to wires that could cause a short circuit

1.2 Package Checklist

- Serial ATA Cable x2
- Rear I/O Panel for ATX Case x1
- Installation Guide x1
- Fully Setup Driver DVD x1

Note: The package contents may be different due to the sales region or models in which it was sold. For more information about the standard package in your region, please contact your dealer or sales representative.

1.3 Motherboard Specifications

SPEC		
CPU	Socket AM3 AMD Sempron / Phenom II / Athlon II processors (Maximum Watt: 95W)	AMD 64 Architecture enables 32 and 64 bit computing Supports Hyper Transport 2.0
FSB	Support Hyper Transport 3.0 Supports up to 3.2 GT/s Bandwidth	
Chipset	AMD 760G AMD SB710	
Super I/O	ITE 8728F-BX Provides the most commonly used legacy Super I/O functionality	Low Pin Count Interface Environment Control initiatives H/W Monitor ITE's "Smart Guardian" function
Main Memory	DDR3 DIMM Slots x 2 Max Memory Capacity 16GB Each DIMM supports 512MB/1GB/ 2GB/4GB/8GB DDR3	Dual Channel Mode DDR3 memory module Supports DDR3 800/1066/1333/1600(OC) Registered DIMM and ECC DIMM is not supported
Graphics	Integrated in AMD 760G Chipset	Max Shared Video Memory is 1024MB
SATA II	Integrated Serial ATA Controller	Data transfer rates up to 3 Gb/s SATA Version 2.0 specification compliant
LAN	Realtek RTL 8105T	10 / 100 Mb/s auto negotiation
Sound	VT1708B / ALC662	5.1 channels audio out High Definition Audio
Slots	PCI Express X16 slot x1 PCI slot x1	Supports PCI-E X16 expansion card Supports PCI expansion cards
On Board Connectors	SATA Connector x4 IDE Connector x1 Front Panel Connector x1 Front Audio Connector x1 CPU Fan Header x1	Each connector supports 1 SATA device Each connector supports 2 IDE device Supports front panel facilities Supports front panel audio function CPU Fan power supply (with Smart Fan function)

SPEC			
	System Fan Header	x1	System Fan Power supply
	CMOS Clear Jumper	x1	Restore CMOS data to factory default setting
	USB Connector	x2	Each connector supports 2 front panel USB ports
	Power Connector (24pin)	x1	Connects to Power supply
	Power Connector (4pin)	x1	Connects to Power supply
	Printer Port Connector	x1	Each connector supports 1 Printer port
Back Panel I/O	PS/2 Keyboard	x1	Connects to PS/2 Keyboard
	PS/2 Mouse	x1	Connects to PS/2 Mouse
	VGA port	x1	Connect to D-SUB monitor
	LAN port	x1	Connect to RJ-45 Ethernet cable
	USB Port	x4	Connect to USB devices
	Audio Jack	x3	Provide Audio-In/Out and microphone connection
Board Size	182 mm(W) x 225 mm(L)		
Special Features	RAID 0 / 1 / 10 support		
OS Support	Windows XP / Vista / 7 / 8		Biostar reserves the right to add or remove support for any OS With or without notice.

1.4 Rear Panel Connectors

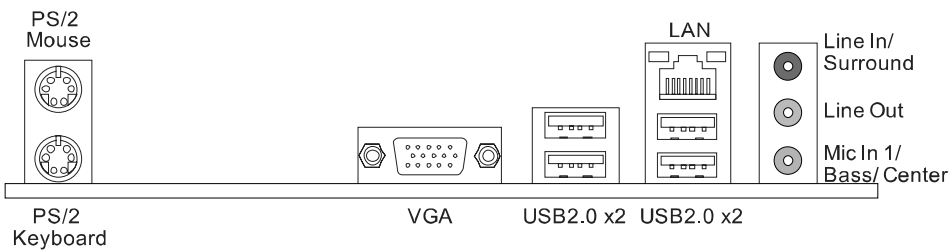

1.5 Motherboard Layout

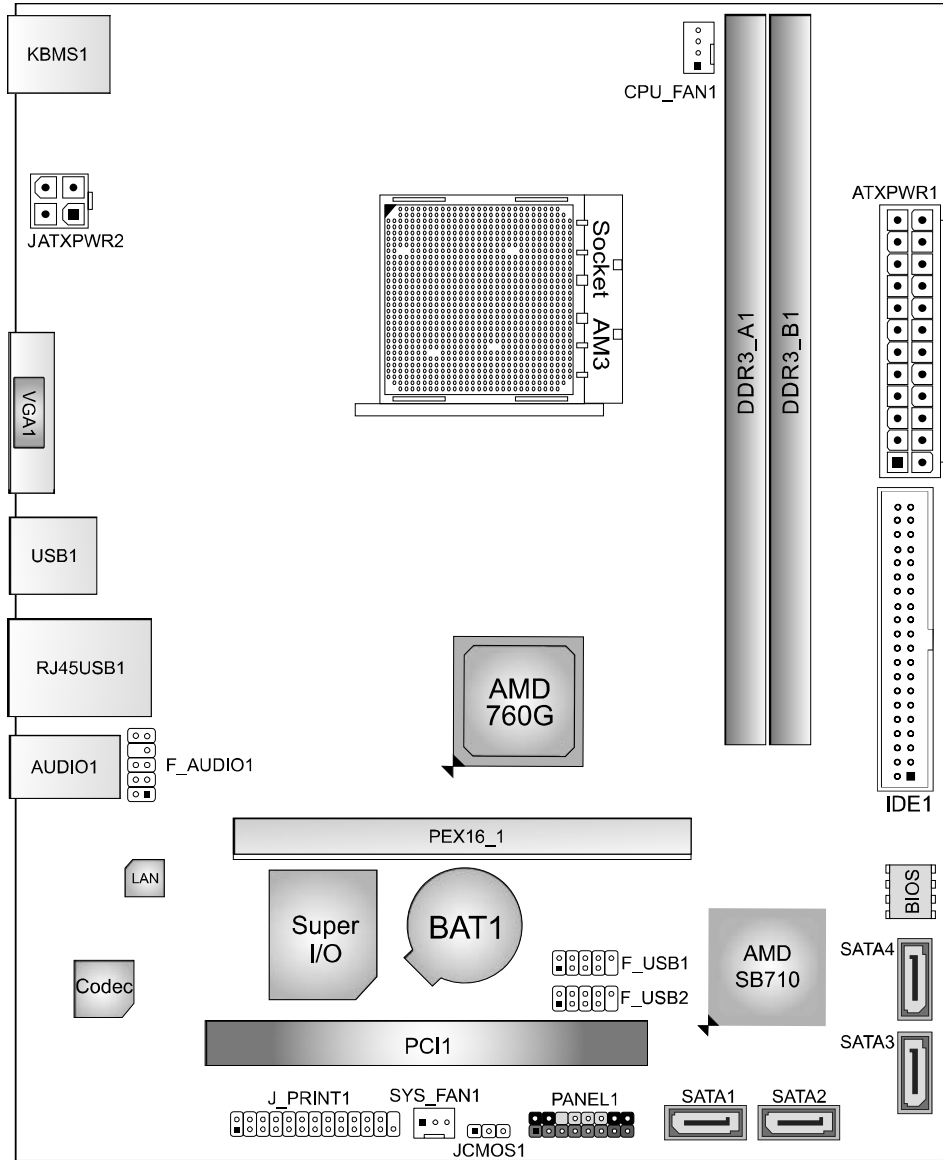

Note: ■ represents the 1st pin.

CHAPTER 2: HARDWARE INSTALLATION

2.1 Install Central Processing Unit (CPU)

Step 1: Locate the CPU socket on the motherboard

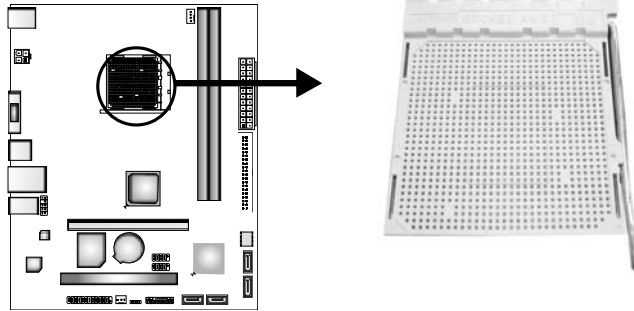

Step 2: Pull the socket locking out from the socket and then raise the lever up to a 90-degree angle.

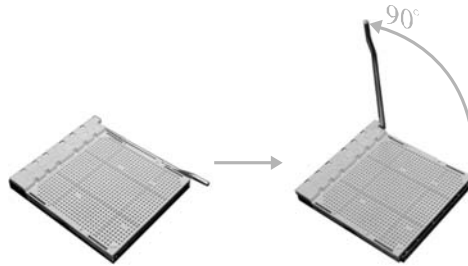

Step 3: Look for the white triangle on socket, and the gold triangle on CPU should point towards this white triangle. The CPU will fit only in the correct orientation.



to prevent damaging the CPU.

Step 4: Hold the CPU down firmly, and then close the lever to locked the position

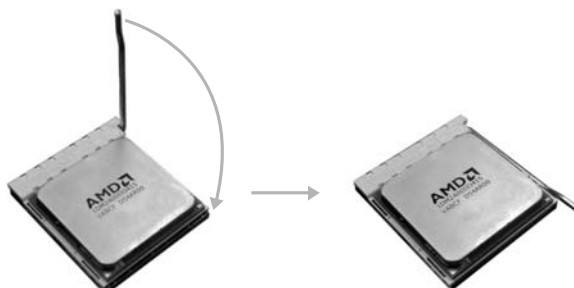

2.2 Install a Heatsink

Step 1: Place the heatsink and fan assembly onto the retention frame. Match the heatsink clip with the socket mounting-lug. Hook the spring clip to the mounting-lug.

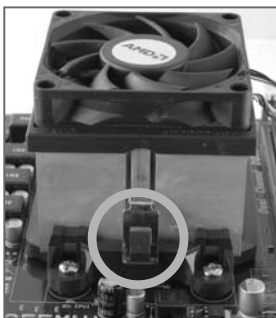

Step 2: On the other side, push the retention clip straight down to lock into the plastic lug on the retention frame, and then press down the locker until it stops.

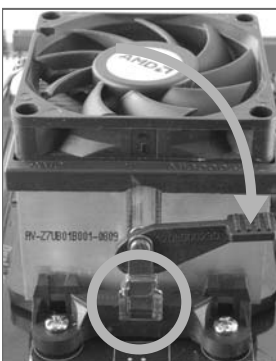

Note1: Do not forget to connect the CPU fan connector.

Note2: For proper installation, please kindly refer to the installation manual of your CPU heatsink.

2.3 Connect Cooling Fans

These fan headers support cooling-fans built in the computer. The fan cable and connector may be different according to the fan manufacturer. Connect the fan cable to the connector while matching the black wire to pin#1.

CPU_FAN1: CPU Fan Header

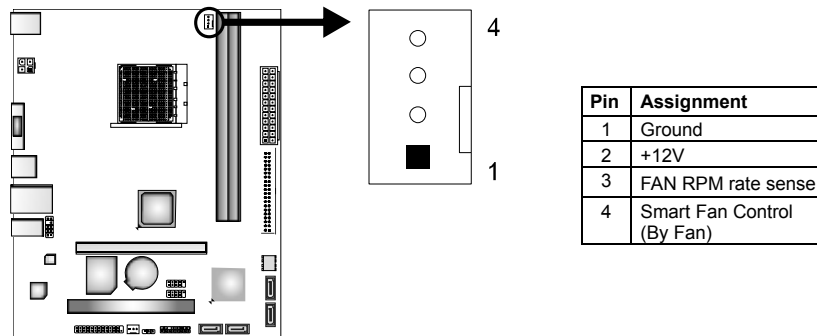

SYS_FAN1: System Fan Header

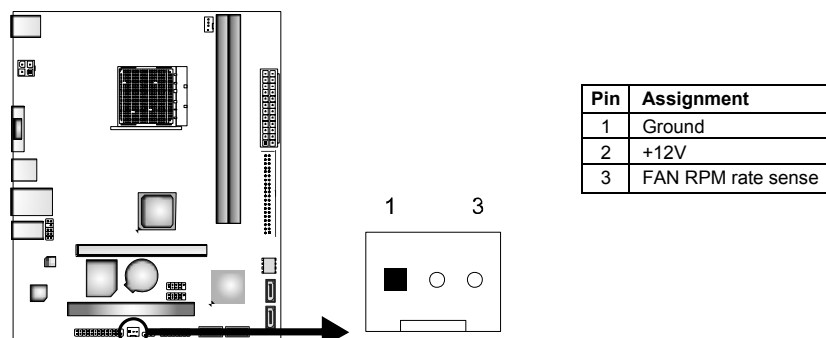

Note: CPU_FAN1, SYS_FAN1 support 4-pin and 3-pin head connectors. When connecting with wires onto connectors, please note that the red wire is the positive and should be connected to pin#2, and the black wire is Ground and should be connected to GND.

2.4 Installing System Memory

A. DDR3 Memory Modules

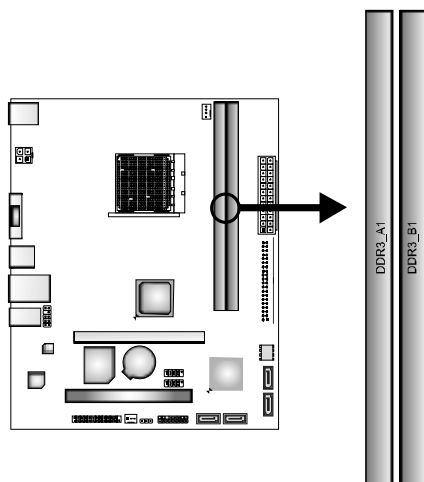

Step 1: Unlock a DIMM slot by pressing the retaining clips outward. Align a DIMM on the slot such that the notch on the DIMM matches the break on the slot.

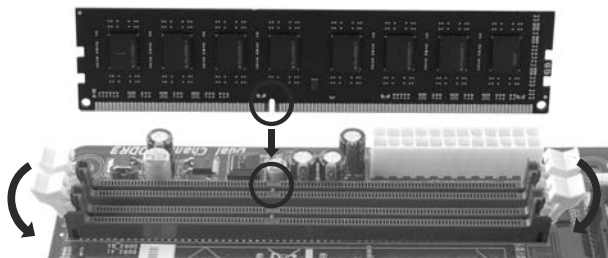

Step 2: Insert the DIMM vertically and firmly into the slot until the retaining chip snap back in place and the DIMM is properly seated.

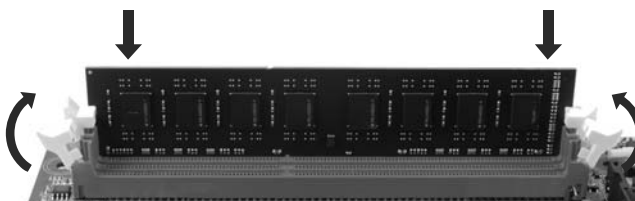

Note: If the DIMM does not go in smoothly, do not force it. Pull it all the way out and try again.

B. Memory Capacity

DIMM Socket Location	DDR3 Module	Total Memory Size
DDR3_A1	512MB/1GB/2GB/4GB/8GB	Max is 16GB.
DDR3_B1	512MB/1GB/2GB/4GB/8GB	

C. Dual Channel Memory installation

Please refer to the following requirements to activate Dual Channel function:

Install memory module of the same density in pairs, shown in the table.

Dual Channel Status	DDR3_A1	DDR3_B1
Disabled	O	X
Disabled	X	O
Enabled	O	O

(O means memory installed, X means memory not installed.)

The DRAM bus width of the memory module must be the same (x8 or x16)

2.5 Expansion Slots

PEX16_1: PCI-Express X16 Slot

- PCI-Express 2.0 compliant.
- Maximum theoretical realized bandwidth of 4GB/s simultaneously per direction, for an aggregate of 8GB/s totally.
- PCI-Express supports a raw bit-rate of 2.5Gb/s on the data pins.

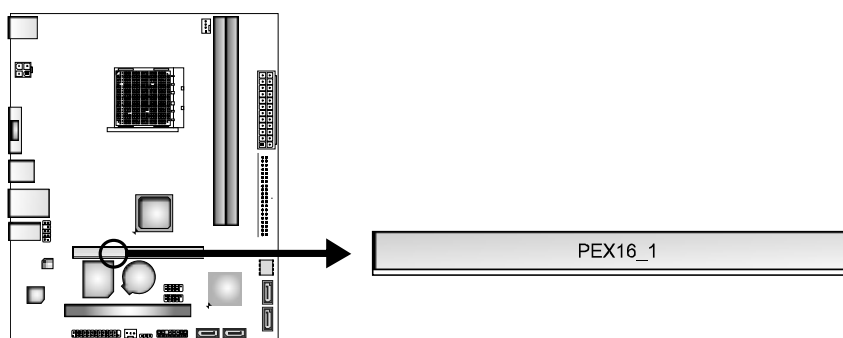

PCI1: Peripheral Component Interconnect Slot

This motherboard is equipped with 1 standard PCI slot. PCI stands for Peripheral Component Interconnect, and it is a bus standard for expansion cards. This PCI slot is designated as 32 bits.

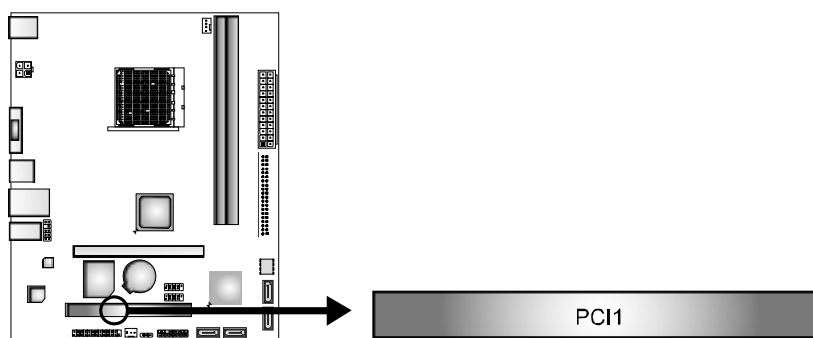

2.6 Jumper Setting

The illustration shows how to set up jumpers. When the jumper cap is placed on pins, the jumper is “close”, if not, that means the jumper is “open”.



JCMOS1: Clear CMOS Jumper

Placing the jumper on pin2-3 allows user to restore BIOS safe setting and CMOS data. Please carefully follow the procedures to avoid damaging the motherboard.

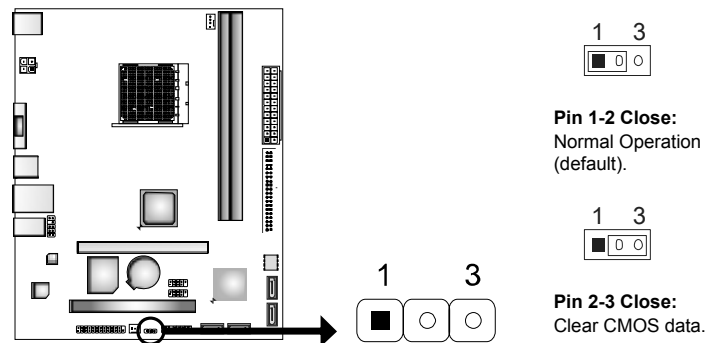

※ Clear CMOS Procedures:

1. Remove AC power line.
2. Set the jumper to “Pin 2-3 close”.
3. Wait for five seconds.
4. Set the jumper to “Pin 1-2 close”.
5. Power on the AC.
6. Load Optimal Defaults and save settings in CMOS.

2.7 Headers & Connectors

ATXPWR1: ATX Power Source Connector

This connector allows user to connect 24-pin power connector on the ATX power supply.

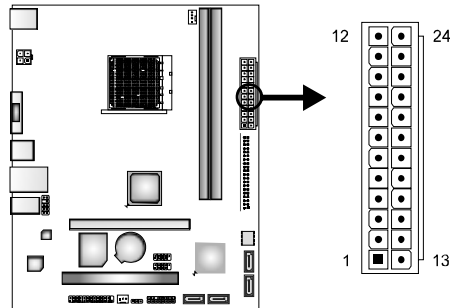

Pin	Assignment	Pin	Assignment
13	+3.3V	1	+3.3V
14	-12V	2	+3.3V
15	Ground	3	Ground
16	PS_ON	4	+5V
17	Ground	5	Ground
18	Ground	6	+5V
19	Ground	7	Ground
20	NC	8	PW_OK
21	+5V	9	Standby Voltage+5V
22	+5V	10	+12V
23	+5V	11	+12V
24	Ground	12	+3.3V

ATXPWR2: ATX Power Source Connector

This connector provides +12V to CPU power circuit.

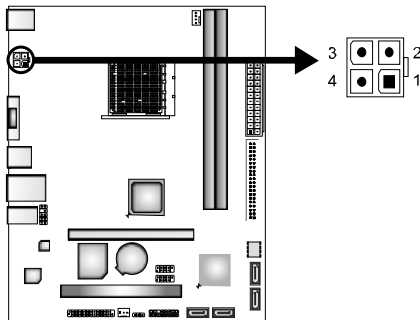

Pin	Assignment
1	+12V
2	+12V
3	Ground
4	Ground

Note1: Before you power on the system, please make sure that both ATXPWR1 and ATXPWR2 connectors have been plugged-in.

Note2: Insufficient power supplied to the system may result in instability or the peripherals not functioning properly. Use of a PSU with a higher power output is recommended when configuring a system with more power-consuming devices.

PANEL1: Front Panel Header

This 16-pin connector includes Power-on, Reset, HDD LED, Power LED, and speaker connection. It allows user to connect the PC case's front panel switch functions.

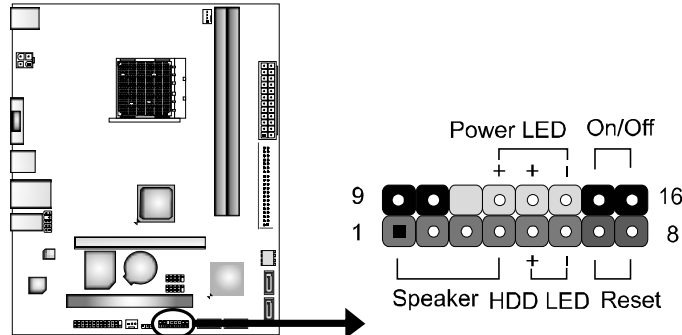

Pin	Assignment	Function	Pin	Assignment	Function
1	+5V	Speaker Connector	9	N/A	N/A
2	N/A		10	N/A	N/A
3	N/A		11	N/A	N/A
4	Speaker	Hard drive LED	12	Power LED (+)	Power LED
5	HDD LED (+)		13	Power LED (+)	
6	HDD LED (-)	Reset button	14	Power LED (-)	
7	Ground		15	Power button	Power-on button
8	Reset control	16	Ground		

SATA1~SATA4: Serial ATA Connectors

These connectors connect to SATA hard disk drives via SATA cables. It satisfies the SATA 2.0 spec and with transfer rate of 3Gb/s.

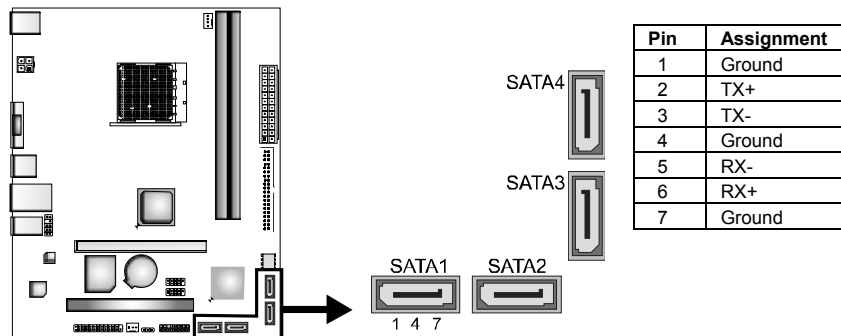

IDE1: Hard Disk Connector

The motherboard has a 32-bit Enhanced IDE Controller that provides PIO Mode 0~4, Bus Master, Multi-word DMA, and Ultra DMA 33/66/100/133 functionality.

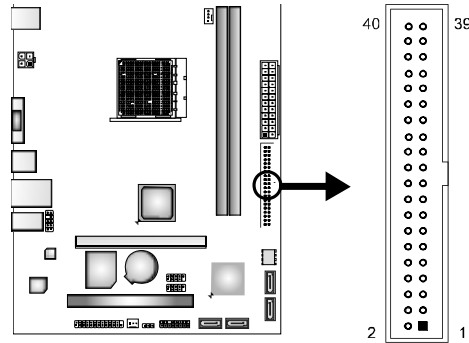

F_USB1/F_USB2: Headers for USB 2.0 Ports at Front Panel

These headers allow user to connect additional USB cable on the PC front panel, and also can be connected with internal USB devices, like USB card reader.

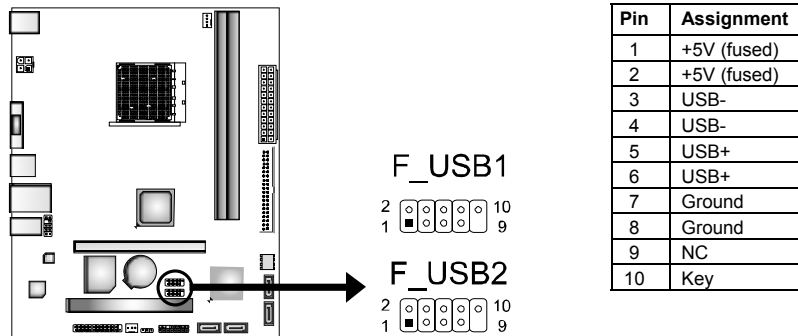

F_AUDIO1: Front Panel Audio Header

This header allows user to connect the front audio output cable with the PC front panel. This header allows only HD audio front panel connector; AC'97 connector is not acceptable.

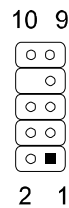
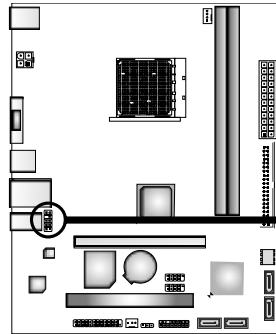

Pin	Assignment
1	Mic Left in
2	Ground
3	Mic Right in
4	GPIO
5	Right line in
6	Jack Sense
7	Front Sense
8	Key
9	Left line in
10	Jack Sense

J_PRINT1: Printer Port Connector

This header allows you to connector printer on the PC.

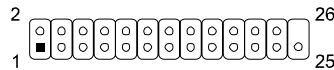
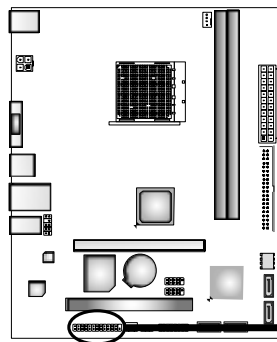

Pin	Assignment	Pin	Assignment
1	-Strobe	14	Ground
2	-ALF	15	Data 6
3	Data 0	16	Ground
4	-Error	17	Data 7
5	Data 1	18	Ground
6	-Init	19	-ACK
7	Data 2	20	Ground
8	-Scltin	21	Busy
9	Data 3	22	Ground
10	Ground	23	PE
11	Data 4	24	Ground
12	Ground	25	SCLT
13	Data 5	26	Key

CHAPTER 3: BIOS & SOFTWARE

3.1 BIOS Setup

- For better system performance, the BIOS firmware is being continuously updated. The BIOS information described below in this manual is for your reference only and the actual BIOS information and settings on board may be different from this manual
- For further information of setting up the BIOS, please refer to the BIOS Manual in the Setup DVD.

3.2 BIOS Update

There are three ways to update the BIOS:
BIOS Update Utility, BIOS Online Update Utility and BIOS Flasher.

1. BIOS Update Utility

1. Installing BIOS Update Utility from the DVD Driver.
2. Download the proper BIOS from www.biostar.com.tw.

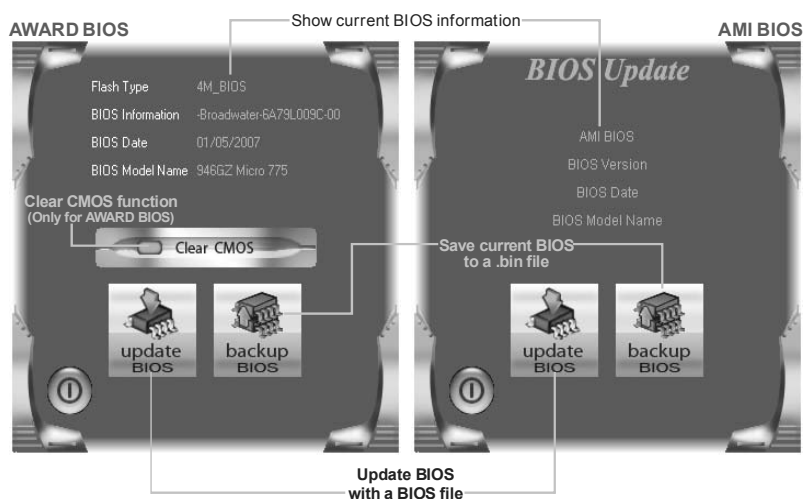

<Backup BIOS>

Once click on this button, the saving dialog will show. Choose the position to save file and enter file name. (We recommend that the file name should be English/number and no longer than 7 characters.) Then click **Save**.

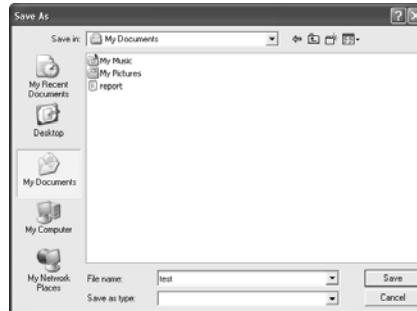
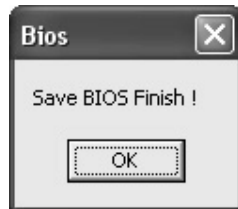

After the saving process, finish dialog will show. Click on **OK** to complete the BIOS Backup procedure.

<Update BIOS>

Before doing this, please download the proper BIOS file from the website.

For AWARD BIOS, update BIOS procedure should be run with Clear CMOS function, so please check on Clear CMOS first.

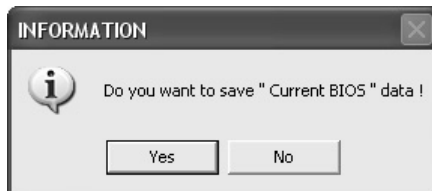

Then click Update BIOS button, a dialog will show for asking you backup current BIOS. Click **Yes** for BIOS backup and refer to the Backup BIOS procedure; or click **No** to skip this procedure.

After the BIOS Backup procedure, the open dialog will show for requesting the BIOS file which is going to be updated. Please choose the proper BIOS file for updating, then click on **Open**.

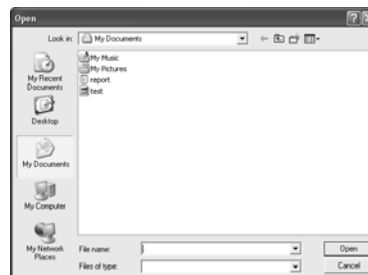

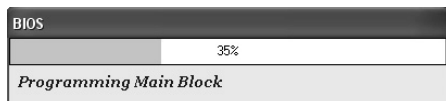

The utility will update BIOS with the proper BIOS file, and this process may take minutes. Please do not open any other applications during this process.

After the BIOS Update process, click on **OK** to restart the system.

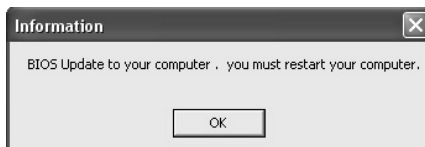

While the system boots up and the full screen logo shows, press  <Delete> key to enter BIOS setup.

In the BIOS setup, use the **Load Optimized Defaults** function and then **Save and Exit Setup** to exit BIOS setup. BIOS Update is completed.

2. Online Update Utility

1. Installing BIOS Update Utility from the DVD Driver.
2. Please make sure the system is connected to the internet before using this function.

3. Open BIOS Update Utility and click the **Online Update** button on the main screen.



4. An open dialog will show up to request your agreement to start the BIOS update. Click **Yes** to start the online update procedure.

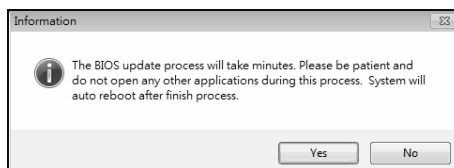

5. If there is a new BIOS version, the utility will ask you to download it. Click **Yes** to proceed.

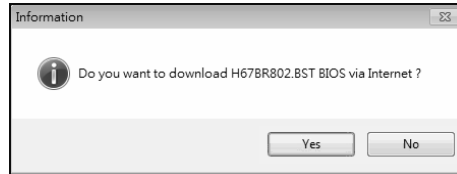

6. After the download is completed, you will be asked to program (update) the BIOS or not. Click **Yes** to proceed.

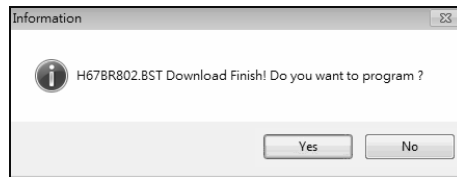

7. After the updating process is finished, you will be asked you to reboot the system. Click **OK** to reboot.

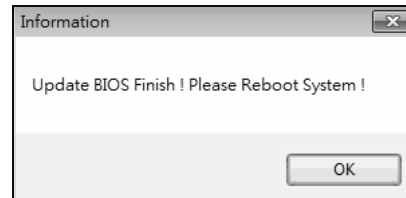

8. While the system boots up and the full screen logo shows up, press  <Delete> key to enter BIOS setup.

After entering the BIOS setup, please go to the **Save & Exit**, using the **Restore Defaults** function to load Optimized Defaults, and select **Save Changes and Reset** to restart the computer. Then, the BIOS Update is completed.

3. BIOSTAR BIOS Flasher

BIOSTAR BIOS Flasher is a BIOS flashing utility providing you an easy and simple way to update your BIOS via USB pen drive.

Note1: This utility only allows storage device with FAT32/16 format and single partition.

Note2: Shutting down or resetting the system while updating the BIOS will lead to system boot failure.

The BIOSTAR BIOS Flasher is built in the BIOS ROM. To enter the utility, press **<F12>** during the **Power-On Self Tests (POST)** procedure while booting up.

Updating BIOS with BIOSTAR BIOS Flasher

1. Go to the website to download the latest BIOS file for the motherboard.
2. Then, save the BIOS file into a USB pen drive or a floppy disk.
3. Insert the USB pen drive or the floppy disk that contains the BIOS file to the USB port or the floppy disk drive.



4. Power on or reset the computer and then press **<F12>** during the **POST** process. A select dialog as the picture on the right appears. Select the device contains the BIOS file and press **<Enter>** to enter the utility.
5. The utility will show the BIOS files and their respective information. Select the proper BIOS file and press **<Enter>** then **<Y>** to perform the BIOS update process.
6. After the update process, the utility will ask you to reboot the system. Press **<Y>** to proceed. BIOS update completes.



3.3 Software

Installing Software

1. Insert the Setup CD to the optical drive. The drivers installation program would appear if the Autorun function has been enabled.
2. Select **Software Installation**, and then click on the respective software title.
3. Follow the on-screen instructions to complete the installation.

Note1: All the information and content about following software are subject to be changed without notice. For better performance, the software is being continuously updated.

Note2: The information and pictures described below are for your reference only. The actual information and settings on board may be slightly different from this manual.

Launching Software

After the installation process, you will see the software icon “eHOT Line” / “BIOS Update” appears on the desktop. Double-click the icon to launch the utility.

eHot-Line (Optional)

eHot-Line is a convenient utility that helps you to contact with our Tech-Support system. This utility will collect the system information which is useful for analyzing the problem you may have encountered, and then send these information to our tech-support department to help you fix the problem.

Note: Before you use this utility, please set Outlook Express as your default e-mail client application program.

* represents important information that you must provide. Without this information, you may not be able to send out the mail.

This block will show the information which would be collected in the mail.

* Describe condition of your system.

* Select your area or the area close to you.

Provide the e-mail address that you would like to send the copy to.

* Provide the name of the memory module manufacturer.

Provide the name of the power supply manufacturer and the model no.

Send the mail out.

Exit this dialog.

Save these information to a .txt file

Base board information :
Caption : Base Board
CreationClassName : Win32_Base
Description : Base Board
HostingBoard : TRUE
HotSwappable : FALSE
Manufacturer : BIOSTAR Group
Name : Base Board
PoweredOn : TRUE
Product : TA780G IM2+
Removable : FALSE
Replaceable : TRUE
RequiresDaughterBoard : FALSE
SerialNumber : None
Status : OK
Tag : Base Board
Version : 6.0

Symptom Description :

Region :

CC E-mail :

Memory Module Manufacture :

Power Supply Manufacture/model :

Send Save As... Exit

After filling up this information, click “Send” to send the mail out. A warning dialog would appear asking for your confirmation; click “Send” to confirm or “Do Not Send” to cancel.



If you want to save this information to a .txt file, click “Save As...” and then you will see a saving dialog appears asking you to enter file name.

Enter the file name and then click “Save”. Your system information will be saved to a .txt file.

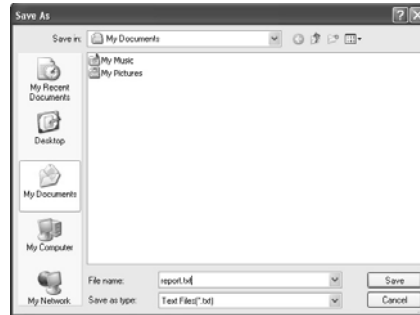

Open the saved .txt file, you will see your system information including motherboard/BIOS/CPU/video/ device/OS information. This information is also concluded in the sent mail.

Note1: We will not share customer’s data with any other third parties, so please feel free to provide your system information while using eHot-Line service.
Note2: If you are not using Outlook Express as your default e-mail client application, you may need to save the system information to a .txt file and send the file to our tech support with other e-mail application. Go to the following web <http://www.biostar.com.tw/app/en/about/contact.php> for getting our contact information.

BIOScreen Utility (Optional)

This utility allows you to personalize your boot logo easily. You can choose BMP as your boot logo so as to customize your computer.



Please follow the following instructions to update boot logo:

1. **Load Image** : Choose the picture as the boot logo.
2. **Transform** : Transform the picture for BIOS and preview the result.
3. **Update Bios** : Write the picture to BIOS Memory to complete the update.

CHAPTER 4: USEFUL HELP

4.1 Driver Installation

After you installed your operating system, please insert the Fully Setup Driver DVD into your optical drive and install the driver for better system performance.

You will see the following window after you insert the DVD

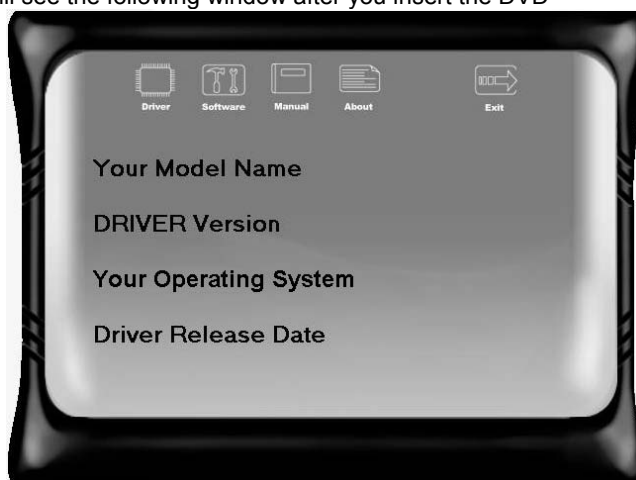

The setup guide will auto detect your motherboard and operating system.

Note: If this window didn't show up after you insert the Driver DVD, please use file browser to locate and execute the file SETUP.EXE under your optical drive.

A. Driver Installation

To install the driver, please click on the Driver icon. The setup guide will list the compatible driver for your motherboard and operating system. Click on each device driver to launch the installation program.

B. Software Installation

To install the software, please click on the Software icon. The setup guide will list the software available for your system, click on each software title to launch the installation program.

C. Manual

Aside from the paperback manual, we also provide manual in the Driver DVD. Click on the Manual icon to browse for available manual.

Note: You will need Acrobat Reader to open the manual file. Please download the latest version of Acrobat Reader software from <http://get.adobe.com/reader/>

4.2 Troubleshooting

Probable	Solution
1. There is no power in the system. Power LED does not shine; the fan of the power supply does not work 2. Indicator light on keyboard does not shine.	1. Make sure power cable is securely plugged in. 2. Replace cable. 3. Contact technical support.
System is inoperative. Keyboard lights are on, power indicator lights are lit, and hard drives are running.	Using even pressure on both ends of the DIMM, press down firmly until the module snaps into place.
System does not boot from a hard disk drive, but can be booted from optical drive.	1. Check cable running from disk to disk controller board. Make sure both ends are securely plugged in; check the drive type in the standard CMOS setup. 2. Backing up the hard drive is extremely important. All hard disks are capable of breaking down at any time.
System only boots from an optical drive. Hard disks can be read, applications can be used, but system fails to boot from a hard disk.	1. Back up data and applications files. 2. Reformat the hard drive. Re-install applications and data using backup disks.
Screen message shows "Invalid Configuration" or "CMOS Failure."	Review system's equipment. Make sure correct information is in setup.
System cannot boot after user installs a second hard drive.	1. Set master/slave jumpers correctly. 2. Run SETUP program and select correct drive types. Call the drive manufacturers for compatibility with other drives.

CPU Overheated

If the system shutdown automatically after power on system for seconds, that means the CPU protection function has been activated.

When the CPU is over heated, the motherboard will shutdown automatically to avoid a damage of the CPU, and the system may not power on again.

In this case, please double check:

1. The CPU cooler surface is placed evenly with the CPU surface.
2. CPU fan is rotated normally.
3. CPU fan speed is fulfilling with the CPU speed.

After confirmed, please follow steps below to relief the CPU protection function.

1. Remove the power cord from power supply for seconds.
2. Wait for seconds.
3. Plug in the power cord and boot up the system.

Or you can:

1. Clear the CMOS data.
(See "Close CMOS Header: JCMOS1" section)
2. Wait for seconds.
3. Power on the system again.

4.3 RAID Functions

Operating System

- Supports Windows XP, Windows Vista, and Windows 7.

Raid Arrays

RAID supports the following types of RAID arrays:

RAID 0: RAID 0 defines a disk striping scheme that improves disk read and write times for many applications.

RAID 1: RAID 1 defines techniques for mirroring data.

RAID 10: RAID 10 combines the techniques used in RAID 0 and RAID 1.

How RAID Works

RAID 0:

The controller “stripes” data across multiple drives in a RAID 0 array system. It breaks up a large file into smaller blocks and performs disk reads and writes across multiple drives in parallel. The size of each block is determined by the stripe size parameter, which you set during the creation of the RAID set based on the system environment. This technique reduces overall disk access time and offers high bandwidth.

Features and Benefits

- **Drives:** Minimum 1, and maximum is up to 6 or 8. Depending on the platform.
- **Uses:** Intended for non-critical data requiring high data throughput, or any environment that does not require fault tolerance.
- **Benefits:** provides increased data throughput, especially for large files. No capacity loss penalty for parity.
- **Drawbacks:** Does not deliver any fault tolerance. If any drive in the array fails, all data is lost.
- **Fault Tolerance:** No.
- **Total Capacity:** (Minimal. HDD Capacity) x (Connected HDDs Amount)

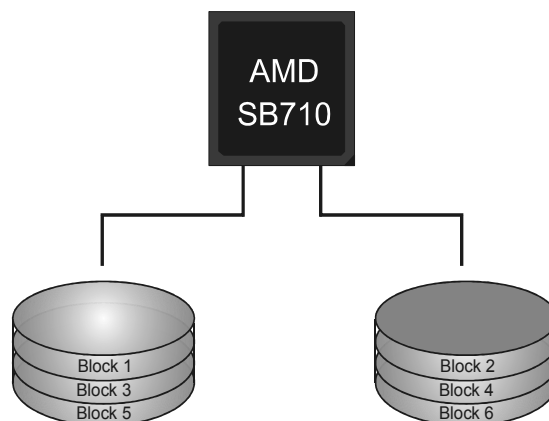

RAID 1:

Every read and write is actually carried out in parallel across 2 disk drives in a RAID 1 array system. The mirrored (backup) copy of the data can reside on the same disk or on a second redundant drive in the array. RAID 1 provides a hot-standby copy of data if the active volume or drive is corrupted or becomes unavailable because of a hardware failure.

RAID techniques can be applied for high-availability solutions, or as a form of automatic backup that eliminates tedious manual backups to more expensive and less reliable media.

Features and Benefits

- **Drives:** Minimum 2, and maximum is 2.
- **Uses:** RAID 1 is ideal for small databases or any other application that requires fault tolerance and minimal capacity.
- **Benefits:** Provides 100% data redundancy. Should one drive fail, the controller switches to the other drive.
- **Drawbacks:** Requires 2 drives for the storage space of one drive. Performance is impaired during drive rebuilds.
- **Fault Tolerance:** Yes.

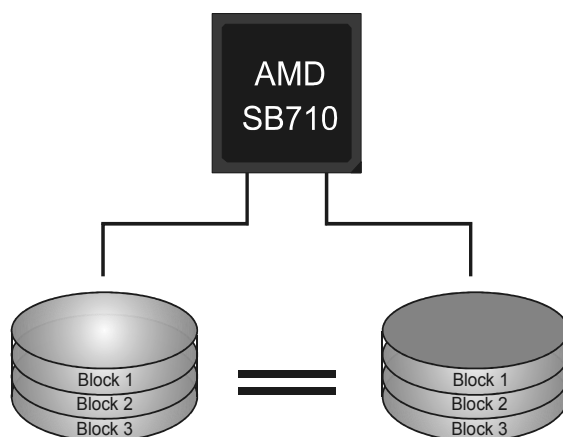

RAID 10:

RAID 1 drives can be striped using RAID 0 techniques. Resulting in a RAID 10 solution for improved resiliency, performance and rebuild performance.

Features and Benefits

- **Drives:** Minimum 4, and maximum is 6 or 8, depending on the platform.
- **Benefits:** Optimizes for both fault tolerance and performance, allowing for automatic redundancy. May be simultaneously used with other RAID levels in an array, and allows for spare disks.
- **Drawbacks:** Requires twice the available disk space for data redundancy, the same as RAID level 1.
- **Fault Tolerance:** Yes.

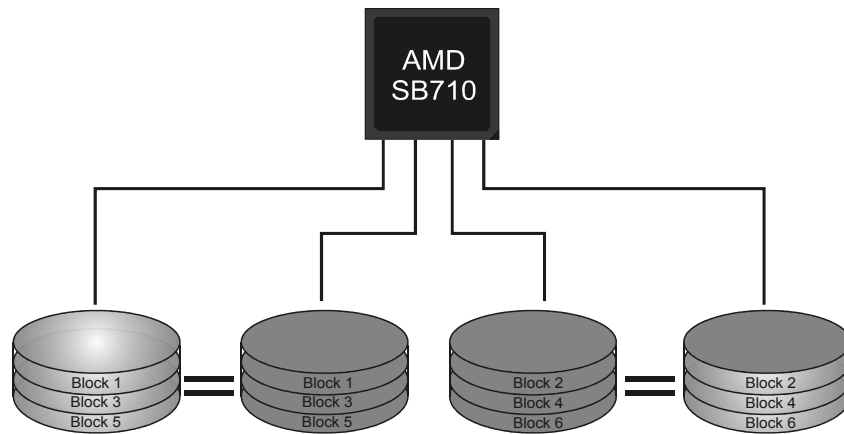

APPENDIX: Specifications In Other Languages**German**

<i>Spezifikationen</i>		
CPU	Sockel AM3 AMD Sempron / Phenom II / Athlon II Prozessoren (Maximales Watt: 95W)	Die AMD 64-Architektur unterstützt eine 32-Bit- und 64-Bit-Datenverarbeitung Unterstützt Hyper Transport 2.0
FSB	Unterstützt Hyper Transport 3.0 mit einer Bandbreite von bis zu 3.2 GT/s	
Chipsatz	AMD 760G AMD SB710	
Super E/A	ITE8728F-BX Bietet die häufig verwendeten alten Super E/A-Funktionen.	Low Pin Count-Schnittstelle Umgebungskontrolle, Hardware-Überwachung "Smart Guardian"-Funktion von ITE
Arbeitsspeiche r	DDR3 DIMM-Steckplätze x 2 Max. 16GB Arbeitsspeicher Jeder DIMM unterstützt 512MB/1GB/ 2GB/4GB/8GB DDR3.	Dual-Kanal DDR3 Speichermodul Unterstützt DDR3 800/1066/1333/1600(OC) registrierte DIMMs. ECC DIMMs werden nicht unterstützt.
Grafik	Integrierter AMD 760G-Chipsatz	Max. 1024MB gemeinsam benutzter Videospeicher
SATA	Integrierter Serial ATA-Controller	Datentransferrate bis zu 3 Gb/s Konform mit der SATA-Spezifikation Version 2.0.
LAN	Realtek RTL 8105T	10 / 100 Mb/s Auto-Negotiation
HD Audio-Unterstützung	VT1708B / ALC662	5.1-Kanal-Audioausgabe Unterstützt High-Definition Audio
Steckplätze	PCI Express X16 Steckplatz x1 PCI-Steckplatz x1	
Onboard-Anschluss	SATA-Anschluss x4 IDE-Anschluss x1 Fronttafelanschluss x1	Jeder Anschluss unterstützt 1 SATA-Laufwerk Jeder Anschluss unterstützt 2 IDE-Laufwerke Unterstützt die Fronttafelanforderungen

Spezifikationen			
	Front-Audioanschluss	x1	Unterstützt die Fronttafel-Audioanschlussfunktion
	CPU-Lüfter-Sockel	x1	CPU-Lüfterstromversorgungsanschluss (mit Smart Fan-Funktion)
	System-Lüfter-Sockel	x1	System-Lüfter-Stromversorgungsanschluss
	"CMOS löschen"-Sockel	x1	
	USB-Anschluss	x2	Jeder Anschluss unterstützt 2 Fronttafel-USB-Anschlüsse
	Stromanschluss (24-polig)	x1	
	Stromanschluss (4-polig)	x1	
	Druckeranschluss Anschluss	x1	Jeder Anschluss unterstützt 1 Druckeranschluss
Rückseiten-E/A	PS/2-Tastatur	x1	
	PS/2-Maus	x1	
	VGA-Anschluss	x1	
	LAN-Anschluss	x1	
	USB-Anschluss	x4	
	Audioanschluss	x3	
Platinengröße	182 mm (B) X 225 mm (L)		
Sonderfunktionen	Unterstützt RAID 0 / 1 / 10		
OS-Unterstützung	Windows XP / Vista / 7 / 8		Biostar behält sich das Recht vor, ohne Ankündigung die Unterstützung für ein Betriebssystem hinzuzufügen oder zu entfernen.

French

SPEC		
UC	Socket AM3 Processeurs AMD Sempron / Phenom II / Athlon II (Watt maximum : 95W)	L'architecture AMD 64 permet le calcul 32 et 64 bits Prend en charge Hyper Transport 2.0
Bus frontal	Prend en charge Hyper Transport 3.0 jusqu'à une bande passante de 3.2 GT/s	
Chipset	AMD 760G AMD SB710	
Super E/S	ITE 8728F-BX Fournit la fonctionnalité de Super E/S patrimoniales la plus utilisée.	Interface à faible compte de broches Initiatives de contrôle environnementales, Moniteur de matériel Fonction "Gardien intelligent" de l'ITE
Mémoire principale	Fentes DDR3 DIMM x 2 Capacité mémoire maximale de 16Go Chaque DIMM prend en charge des DDR3 de 512Mo/1Go/2Go/4Go/8Go	Module de mémoire DDR3 à mode à double voie Prend en charge la DDR3 800/1066/1333/1600(OC) Les DIMM à registres et DIMM avec code correcteurs d'erreurs ne sont pas prises en charge
Graphiques	Intégré dans la chipset AMD 760G	Mémoire vidéo partagée maximale de 1024 Mo
SATA	Contrôleur Serial ATA intégré	Taux de transfert jusqu'à 3 Go/s. Conforme à la spécification SATA Version 2.0
LAN	Realtek RTL 8105T	10 / 100 Mb/s négociation automatique
Prise en charge audio HD	VT1708B / ALC662	Sortie audio à 5.1 voies Prise en charge de l'audio haute définition
Fentes	Fente PCI Express X16 x1 Fente PCI x1	
Connecteur embarqué	Connecteur SATA x4 Connecteur IDE x1 Connecteur du panneau avant x1 Connecteur Audio du panneau avant x1	Chaque connecteur prend en charge 1 périphérique SATA Chaque connecteur prend en charge 2 périphériques IDE Prend en charge les équipements du panneau avant Prend en charge la fonction audio du panneau avant

SPEC			
	Embase de ventilateur UC	x1	Alimentation électrique du ventilateur UC (avec fonction de ventilateur intelligent)
	Embase de ventilateur système	x1	Alimentation électrique du ventilateur système
	Embase d'effacement CMOS	x1	
	Connecteur USB	x2	Chaque connecteur prend en charge 2 ports USB de panneau avant
	Connecteur d'alimentation (24 broches)	x1	
	Connecteur d'alimentation (4 broches)	x1	
	Connecteur de Port d'imprimante	x1	Chaque connecteur prend en charge 1 Port d'imprimante
E/S du panneau arrière	Clavier PS/2	x1	
	Souris PS/2	x1	
	Port VGA	x1	
	Port LAN	x1	
	Port USB	x4	
	Fiche audio	x3	
Dimensions de la carte	182 mm (l) X 225 mm (H)		
Fonctionnalités spéciales	Prise en charge RAID 0 / 1 / 10		
Support SE	Windows XP / Vista / 7 / 8		Biostar se réserve le droit d'ajouter ou de supprimer le support de SE avec ou sans préavis.

Italian

SPECIFICA		
CPU	Socket AM3 Processori AMD Sempron / Phenom II / Athlon II (Watt massimo: 95W)	L'architettura AMD 64 abilita la computazione 32 e 64 bit Supporto di Hyper Transport 2.0
FSB	Supporto di HyperTransport 3.0 fino a 3.2 GT/s di larghezza di banda	
Chipset	AMD 760G AMD SB710	
Super I/O	ITE 8728F-BX Fornisce le funzionalità legacy Super I/O usate più comunemente.	Interfaccia LPC (Low Pin Count) Funzioni di controllo dell'ambiente: Monitoraggio hardware Funzione "Smart Guardian" di ITE
Memoria principale	Alloggi DIMM DDR3 x 2 Capacità massima della memoria 16GB Ciascun DIMM supporta DDR3 512MB/1GB/2GB/4GB/8GB	Modulo di memoria DDR3 a canale doppio Supporto di DDR3 800/1066/1333/1600(OC) DIMM registrati e DIMM ECC non sono supportati
Grafica	Integrata nel Chipset AMD 760G	La memoria video condivisa massima è di 1024 MB
SATA	Controller Serial ATA integrato	Velocità di trasferimento dei dati fino a 3 Gb/s. Compatibile specifiche SATA Versione 2.0.
LAN	Realtek RTL 8105T	Negoziazione automatica 10 / 100 Mb/s
Supporto audio HD	VT1708B / ALC662	Uscita audio 5.1 canali Supporto audio High-Definition (HD)
Alloggi	Alloggio PCI Express X16 x1 Alloggio PCI x1	
Connettori su scheda	Connettore SATA x4 Connettore IDE x1 Connettore pannello frontale x1 Connettore audio frontale x1 Collettore ventolina CPU x1	Ciascun connettore supporta 1 unità SATA Ciascun connettore supporta 2 unità IDE Supporta i servizi del pannello frontale Supporta la funzione audio pannello frontale Alimentazione ventolina CPU (con funzione Smart Fan)

SPECIFICA			
	Collettore ventolina sistema	x1	Alimentazione ventolina di sistema
	Collettore cancellazione CMOS	x1	
	Connettore USB	x2	Ciascun connettore supporta 2 porte USB pannello frontale
	Connettore alimentazione (24 pin)	x1	
	Connettore alimentazione (4 pin)	x1	
	Connettore Porta stampante	x1	Ciascun connettore supporta 1 Porta stampante
I/O pannello posteriore	Tastiera PS/2	x1	
	Mouse PS/2	x1	
	Porta VGA	x1	
	Porta LAN	x1	
	Porta USB	x4	
	Connettore audio	x3	
Dimensioni scheda	182 mm (larghezza) x 225 mm (altezza)		
Caratteristiche speciali	Supporto RAID 0 / 1 / 10		
Sistemi operativi supportati	Windows XP / Vista / 7 / 8		Biostar si riserva il diritto di aggiungere o rimuovere il supporto di qualsiasi sistema operativo senza preavviso.

Spanish

<i>Especificación</i>		
CPU	Conector AM3 Procesadores AMD Sempron / Phenom II / Athlon II (Vatio máximo: 95W)	La arquitectura AMD 64 permite el procesado de 32 y 64 bits Soporta las tecnologías Hyper Transport 2.0
FSB	Admite HyperTransport 3.0 con un ancho de banda de hasta 3.2 GT/s	
Conjunto de chips	AMD 760G AMD SB710	
Súper E/S	ITE 8728F-BX Le ofrece las funcionalidades heredadas de uso más común Súper E/S.	Interfaz de cuenta Low Pin Iniciativas de control de entorno, Monitor hardware Función "Guardia inteligente" de ITE
Memoria principal	Ranuras DIMM DDR3 x 2 Capacidad máxima de memoria de 16GB Cada DIMM admite DDR de 512MB/1GB/2GB/4GB/8GB	Módulo de memoria DDR3 de canal Doble Admite DDR3 de 800/1066/1333/1600(OC) No admite DIMM registrados o DIMM compatibles con ECC
Gráficos	Integrados en el conjunto de chips AMD 760G	Memoria máxima de vídeo compartida de 1024 MB
SATA	Controlador ATA Serie Integrado	Tasas de transferencia de hasta 3 Gb/s. Compatible con la versión SATA 2.0.
Red Local	Realtek RTL 8105T	Negociación de 10 / 100 Mb/s
Soporte de sonido HD	VT1708B / ALC662	Salida de sonido de 5.1 canales Soporte de sonido Alta Definición
Ranuras	Ranura PCI Express X16 X1 Ranura PCI X1	
Conectores en placa	Conector SATA X4 Conector IDE X1 Conector de panel frontal X1 Conector de sonido frontal X1	Cada conector soporta 1 dispositivos SATA Cada conector soporta 2 dispositivos IDE Soporta instalaciones en el panel frontal Soporta funciones de sonido en el panel frontal

<i>Especificación</i>			
	Cabecera de ventilador de CPU	X1	Fuente de alimentación de ventilador de CPU (con función Smart Fan)
	Cabecera de ventilador de sistema	X1	Fuente de alimentación de ventilador de sistema
	Cabecera de borrado de CMOS	X1	
	Conector USB	X2	Cada conector soporta 2 puertos USB frontales
	Conector de alimentación (24 patillas)	X1	
	Conector de alimentación (4 patillas)	X1	
	Conector Puerto de impresora	X1	Cada conector soporta 1 Puerto de impresora
Panel trasero de E/S	Teclado PS/2	X1	
	Ratón PS/2	X1	
	Puerto VGA	X1	
	Puerto de red local	X1	
	Puerto USB	X4	
	Conector de sonido	X3	
Tamaño de la placa	182 mm. (A) X 225 Mm. (H)		
Funciones especiales	Admite RAID 0 / 1 / 10		
Soporte de sistema operativo	Windows XP / Vista / 7 / 8		Biostar se reserva el derecho de añadir o retirar el soporte de cualquier SO con o sin aviso previo.

Portuguese

ESPECIFICAÇÕES		
CPU	Socket AM3 Processadores AMD Sempron / Phenom II / Athlon II (Watt máximo: 95W)	A arquitectura AMD 64 permite uma computação de 32 e 64 bits Suporta as tecnologias Hyper Transport 2.0
FSB	Suporta a tecnologia HyperTransport 2.0 com uma largura de banda até 3.2 GT/s	
Chipset	AMD 760G AMD SB710	
Especificação do Super I/O	ITE 8728F-BX Proporciona as funcionalidades mais utilizadas em termos da especificação Super I/O.	Interface LPC (Low Pin Count). Iniciativas para controlo do ambiente Monitorização do hardware Função "Smart Guardian" da ITE
Memória principal	Ranuras DIMM DDR3 x2 Capacidade máxima de memória: 16GB Cada módulo DIMM suporta uma memória DDR3 de 512MB/1GB/ 2GB/4GB/8GB	Módulo de memória DDR3 de canal duplo Suporta módulos DDR3 800/1066/1333/1600(OC) Os módulos DIMM registados e os DIMM ECC não são suportados
Placa gráfica	Integrada no chipset AMD 760G	Memória de vídeo máxima partilhada: 1024 MB
SATA	Controlador Serial ATA integrado	Velocidades de transmissão de dados até 3 Gb/s. Compatibilidade com a especificação SATA versão 2.0.
LAN	Realtek RTL 8105T	Auto negociação de 10 / 100 Mb/s
Suporte para áudio de alta definição	VT1708B / ALC662	Saída de áudio de 5.1 canais Suporta a especificação High-Definition Audio
Ranuras	Ranhura PCI Express X16 x1 Ranhura PCI x1	
Conectores na placa	Conector SATA x4 Conector IDE x1 Conector do painel frontal x1 Conector de áudio frontal x1	Cada conector suporta 1 dispositivo SATA Cada conector suporta 2 dispositivos IDE Para suporte de várias funções no painel frontal Suporta a função de áudio no painel frontal

ESPECIFICAÇÕES			
	Conector da ventoinha da CPU	x1	Alimentação da ventoinha da CPU (com a função Smart Fan)
	Conector da ventoinha do sistema	x1	Alimentação da ventoinha do sistema
	Conector para limpeza do CMOS	x1	
	Conector USB	x2	Cada conector suporta 2 portas USB no painel frontal
	Conector de alimentação (24 pinos)	x1	
	Conector de alimentação (4 pinos)	x1	
	Conector da para impressora	x1	Cada conector suporta 1 Porta para impressora
Entradas/Saídas no painel traseiro	Teclado PS/2	x1	
	Rato PS/2	x1	
	Porta VGA	x1	
	Porta LAN	x1	
	Porta USB	x4	
	Tomada de áudio	x3	
Tamanho da placa	182 mm (L) X 225 mm (A)		
Características especiais	Suporta as funções RAID 0 / 1 / 10		
Sistemas operativos suportados	Windows XP / Vista / 7 / 8		A Biostar reserva-se o direito de adicionar ou remover suporte para qualquer sistema operativo com ou sem aviso prévio.

Polish

SPEC		
Procesor	Socket AM3 AMD Sempron / Phenom II / Athlon II Procesory (Maksymalny Watt: 95W)	Architektura AMD 64 umożliwia przetwarzanie 32 i 64 bitowe Obsługa Hyper Transport 2.0
FSB	Obsługa HyperTransport 3.0 o szerokości pasma do 3.2 GT/s	
Chipset	AMD 760G AMD SB710	
Pamięć główna	Gniazda DDR3 DIMM x 2 Maks. wielkość pamięci 16GB Każde gniazdo DIMM obsługuje moduły 512MB/1GB/2GB/4GB/8GB DDR3	Moduł pamięci DDR3 z trybem podwójnego kanału Obsługa DDR3 800/1066/1333/1600(OC) Brak obsługi Registered DIMM oraz ECC DIMM
Super I/O	ITE 8728F-BX Zapewnia najbardziej powszechne funkcje Super I/O.	Interfejs Low Pin Count Funkcje kontroli warunków pracy, Monitor H/W Funkcja ITE "Smart Guardian"
Grafika	Zintegrowana w chipsecie AMD 760G	Maks. wielkość współdzielonej pamięci video wynosi 1024 MB
SATA	Zintegrowany kontroler Serial ATA	Transfer danych do 3 Gb/s. Zgodność ze specyfikacją SATA w wersji 2.0.
LAN	Realtek RTL 8105T	10 / 100 Mb/s z automatyczną negocjacją szybkości
Obsługa audio HD	VT1708B / ALC662	5.1 kanałowe wyjście audio Obsługa High-Definition Audio
Gniazda	Gniazdo PCI Express X16 x1 Gniazdo PCI x1	
Złącza wbudowane	Złącze SATA x4 Złącze IDE x1 Złącze panela przedniego x1 Przednie złącze audio x1 Złącze główkowe wentylatora procesora x1	Każde złącze obsługuje 1 urządzenie SATA Każde złącze obsługuje 2 urządzenia IDE Obsługa elementów panela przedniego Obsługa funkcji audio na panelu przednim Zasilanie wentylatora procesora (z funkcją Smart Fan)

SPEC		
	Złącze główkowe wentylatora systemowego x1	Zasilanie wentylatora systemowego
	Złącze główkowe kasowania CMOS x1	
	Złącze USB x2	Każde złącze obsługuje 2 porty USB na panelu przednim
	Złącze zasilania (24 pinowe) x1	
	Złącze zasilania (4 pinowe) x1	
	Złącze Port drukarki x1	Każde złącze obsługuje 1 Port drukarki
Back Panel I/O	Klawiatura PS/2 x1	
	Mysz PS/2 x1	
	Port VGA x1	
	Port LAN x1	
	Port USB x4	
	Gniazdo audio x3	
Wymiary plyty	182 mm (S) X 225 mm (W)	
Funkcje specjalne	Obsługa RAID 0 / 1 / 10	
Obsługa systemu operacyjnego	Windows XP / Vista / 7 / 8	Biostar zastrzega sobie prawo dodawania lub odwoływania obsługi dowolnego systemu operacyjnego bez powiadomienia.

Russian

СПЕЦ		
CPU (центральный процессор)	Гнездо AM3 Процессоры AMD Sempron / Phenom II / Athlon II (Максимальный ватт: 95W)	Архитектура AMD 64 разрешать обработка данных на 32 и 64 бит Поддержка Hyper Transport 2.0
FSB	Поддержка HyperTransport 3.0 с пропускной способностью до 3.2 GT/s	
Набор микросхем	AMD 760G AMD SB710	
Основная память	Слоты DDR3 DIMM x 2 Максимальная ёмкость памяти 16ГБ Каждый модуль DIMM поддерживает 512МБ/1ГБ/2ГБ/4ГБ/8ГБ DDR3	Модуль памяти с двухканальным режимом DDR3 Поддержка DDR3 800/1066/1333/1600(OC) Не поддерживает зарегистрированные модули DIMM and ECC DIMM
Super I/O	ITE 8728F-BX Обеспечивает наиболее используемые действующие функциональные возможности Super I/O.	Интерфейс с низким количеством выводов Инициативы по охране окружающей среды, Аппаратный монитор Функция ITE "Smart Guardian" (Интеллектуальная защита)
Графика	Встроенная в набор микросхем AMD 760G	Максимальная совместно используемая видео память составляет 1024 МБ
SATA	Встроенное последовательное устройство управления ATA	скорость передачи данных до 3 гигабит/с. Соответствие спецификации SATA версия 2.0.
Локальная сеть	Realtek RTL 8105T	Автоматическое согласование 10 / 100 Мб/с
Звуковая поддержка жесткого диска	VT1708B / ALC662	Звуковая поддержка High-Definition 5.1канальный звуковой выход
Слоты	Слот PCI Express X16 x1 Слот PCI x1	
Встроенный разъём	Разъём SATA x4 Разъём IDE x1 Разъём на лицевой панели x1 Входной звуковой разъём x1	Каждый разъём поддерживает 1 устройство SATA Каждый разъём поддерживает 2 встроенных интерфейса накопителей Поддержка устройств на лицевой панели Поддержка звуковых функций на лицевой панели

СПЕЦ			
	Контактирующее приспособление вентилятора центрального процессора	x1	Источник питания для вентилятора центрального процессора (с функцией интеллектуального вентилятора)
	Контактирующее приспособление вентилятора системы	x1	Источник питания для вентилятора системы
	Открытое контактирующее приспособление CMOS	x1	
	USB-разъём	x2	Каждый разъём поддерживает 2 USB-порта на лицевой панели
	Разъём питания (24 вывод)	x1	
	Разъём питания (4 вывод)	x1	
	Разъём Порт подключения принтера	x1	Каждый разъём поддерживает 1 Порт подключения принтера
Задняя панель средств ввода-вывода	Клавиатура PS/2	x1	
	Мышь PS/2	x1	
	Порт VGA	x1	
	Порт LAN	x1	
	USB-порт	x4	
	Гнездо для подключения наушников	x3	
Размер панели	182 мм (Ш) X 225 мм (В)		
Специальные технические характеристики	Поддержка RAID 0 / 1 / 10		
Поддержка OS	Windows XP / Vista / 7 / 8		Biostar сохраняет за собой право добавлять или удалять средства обеспечения для OS с или без предварительного уведомления.

Arabic

المواصفات		
وحدة المعالجة المركزية	AM3 بمقياس AMD Sempron / Phenom II / Athlon II معالجات (95 واط: قصوى واط)	إجراء العمليات الحاسوبية بسرعة 32 و 64 بت AMD 64 يمكن تقنية و Hyper Transport 2.0 تدعم تقنية
النقل الأمامي الجانبي	3.2 GT/s بت تردد يصل إلى 3.0 HyperTransport تدعم تقنية	
مجموعة الشرائح	AMD 760G AMD SB710	
Super I/O	ITE 8728F-BX الأكثر استخداماً Super I/O توفر وظيفة	Low Pin Count Interface تدعم تقنية وسائل التحكم في البيئة: مراقب لمعرفة حالة الأجهزة ITE من "Smart Guardian" وظيفة
الذاكرة الرئيسية	قناة DDR3 DIMM سعة ذاكرة قصوى 16 جيجا بايت ميغا بايت 512/سعة DDR3 تدعم ذاكرة من نوع DIMM تدعم كل قناة و 1/2 و 4 و 8 جيجا بايت	مزدوجة القناة DDR3 وحدة ذاكرة سعت 1600/1333/1066/800 (OC) DDR3 تدعم الذاكرة من نوع ميغا بايت ECC وتلك التي لا تتوافق مع DIMM لا تدعم رقائق الذاكرة
بطاقة الرسومات	AMD 760G منمجة في رقائق	أقصى سعة ذاكرة الفيديو المشتركة 1024 ميغا بايت
SATA	متكامل Serial ATA متحكم	جيجابت/ثانية 3 نقل البيت بسعات تصل إلى 2.0 الإصدار SATA مطابقة لمواصفات
شبكة داخلية	Realtek RTL 8105T	تفويض ثنائي 100/10 ميغا بايت / ثنائية
دعم الصوت عالي التعريف	VT1708B / ALC662	قنوات لخرج الصوت 5.1 تدعم تقنية الصوت عالي التعريف من
التقنيات	قناة PCI Express x16 قناة PCI	عدد 1 عدد 1
المنافذ على سطح اللوحة	منفذ SATA منفذ IDE منفذ اللوحة الأممية منفذ الصوت الأمامي	عدد 4 عدد 1 عدد 1 عدد 1
		يدعم SATA يدعم كل منفذ واحد من أجهزة IDE يدعم كل منفذ اثنين من أجهزة يدعم تجهيزات اللوحة الأممية يدعم وظيفة الصوت باللوحة الأممية

المواصفات		
وصلة مروحة وحدة المعالجة المركزية	عدد 1	Smart Fan توصيل الطاقة لمروحة وحدة المعالجة مع وظيفة
وصلة مروحة النظام	عدد 1	لتوصيل الطاقة لمروحة النظام
وصلة مسح CMOS	عدد 1	
منفذ USB	عدد 2	بالوحدة الأمامية USB يدعم كل منفذ قحني
منفذ توصيل الطاقة (24 دبوس)	عدد 1	
منفذ توصيل الطاقة (4 دبوس)	عدد 1	
منفذ طباعة	عدد 1	
لوحة مفاتيح PS/2	عدد 1	
مؤس PS/2	عدد 1	
منفذ VGA	عدد 1	منفذ دخل/خرج
منفذ شبكة اتصال محلية	عدد 1	اللوحة الخلفية
منفذ USB	عدد 4	
مقيس صوت	عدد 3	
حجم اللوحة	182 مم (عرض) X 225 مم (ارتفاع)	
مزايا خاصة	RAID 0 / 1 / 10 دعم تقنية	
دعم أنظمة التشغيل	Windows XP / Vista / 7 / 8	بحقها في إضافة أو إزالة الدعم لأي نظام تشغيل بإخطار أو Biostar احتفظ بدون إخطار.

Japanese

仕様		
CPU	Socket AM3 AMD Sempron / Phenom II / Athlon II プロセッサ (最高のワット: 95W)	AMD 64アーキテクチャでは 32ビットと64ビット計算が可能です ハイパートランスポート2.0とクールアンドクワイアットをサポートします
FSB	3.2 GT/sのバンド幅までハイパートランスポート3.0をサポートします	
チップセット	AMD 760G AMD SB710	
メインメモリ	DDR3 DIMMスロット x2 最大メモリ容量16GB 各DIMMは 512MB/1GB/2GB/4GB/8GB DDR3をサポート	デュアル チャンネルモードDDR3メモリモジュール DDR3 800/1066/1333/1600(OC) をサポート 登録済みDIMMとECC DIMMはサポートされません
Super I/O	ITE 8728F-BX もつとも一般に使用されるレガシーSuper I/O機能を採用しています。	低ピンカウントインターフェイス 環境コントロールイニシアチブ、 HWモニター ITEの「スマートガーディアン」機能
グラフィックス	AMD 760Gチップセットに統合	最大の共有ビデオメモリは1024MBです
SATA	統合シリアルATAコントローラ	最高3Gb/秒のデータ転送速度 SATAバージョン2.0仕様に準拠。
LAN	Realtek RTL 8105T	10 / 100 Mb/秒のオートネゴシエーション
HDオーディオのサポート	VT1708B / ALC662	5.1チャンネルオーディオアウト ハイデフィニションオーディオのサポート
スロット	PCI Express X16スロット x1 PCIスロット x1	
オンボードコネクタ	SATAコネクタ x4 IDEコネクタ x1 フロントパネルコネクタ x1	各コネクタは1つのSATAデバイスをサポートします 各コネクタは2つのIDEデバイスをサポートします フロントパネル機能をサポートします

仕様			
	フロントオーディオコネクタ	x1	フロントパネルオーディオ機能をサポートします
	CPUファンヘッダ	x1	CPUファン電源装置(スマートファン機能を搭載)
	システムファンヘッダ	x1	システムファン電源装置
	CMOSクリアヘッダ	x1	
	USBコネクタ	x2	各コネクタは2つのフロントパネルUSBポートをサポートします
	電源コネクタ(24ピン)	x1	
	電源コネクタ(4ピン)	x1	
	プリンタポートコネクタ	x1	各コネクタは1つのプリンタポートをサポートします
背面パネル I/O	PS/2キーボード	x1	
	PS/2マウス	x1	
	VGAポート	x1	
	LANポート	x1	
	USBポート	x4	
	オーディオジャック	x3	
ボードサイズ	182 mm (幅) X 225 mm (高さ)		
特殊機能	RAID 0 / 1 / 10 のサポート		
OSサポート	Windows XP / Vista / 7 / 8		Biostarは事前のサポートなしにOSサポートを追加または削除する権利を留保します。

2013/04/01