

## **FCC Information and Copyright**

This equipment has been tested and found to comply with the limits of a Class B digital device, pursuant to Part 15 of the FCC Rules. These limits are designed to provide reasonable protection against harmful interference in a residential installation. This equipment generates, uses, and can radiate radio frequency energy and, if not installed and used in accordance with the instructions, may cause harmful interference to radio communications. There is no guarantee that interference will not occur in a particular installation.

The vendor makes no representations or warranties with respect to the contents here and specially disclaims any implied warranties of merchantability or fitness for any purpose. Further the vendor reserves the right to revise this publication and to make changes to the contents here without obligation to notify any party beforehand.

Duplication of this publication, in part or in whole, is not allowed without first obtaining the vendor's approval in writing.

The content of this user's manual is subject to be changed without notice and we will not be responsible for any mistakes found in this user's manual. All the brand and product names are trademarks of their respective companies.

---

---

## Table of Contents

---

---

<b>Chapter 1: Introduction</b> .....	<b>1</b>
<b>1.1 Before You Start</b> .....	1
<b>1.2 Package Checklist</b> .....	1
<b>1.3 Motherboard Features</b> .....	2
<b>1.4 Rear Panel Connectors</b> .....	3
<b>1.5 Motherboard Layout</b> .....	4
<b>Chapter 2: Hardware Installation</b> .....	<b>5</b>
<b>2.1 Installing Central Processing Unit (CPU)</b> .....	5
<b>2.2 FAN Headers</b> .....	7
<b>2.3 Installing System Memory</b> .....	8
<b>2.4 Connectors and Slots</b> .....	10
<b>Chapter 3: Headers &amp; Jumpers Setup</b> .....	<b>13</b>
<b>3.1 How to Setup Jumpers</b> .....	13
<b>3.2 Detail Settings</b> .....	13
<b>Chapter 4: RAID Functions</b> .....	<b>18</b>
<b>4.1 Operating System</b> .....	18
<b>4.2 Raid Arrays</b> .....	18
<b>4.3 How RAID Works</b> .....	18
<b>Chapter 5: Useful Help</b> .....	<b>21</b>
<b>5.1 Driver Installation Note</b> .....	21
<b>5.2 Software</b> .....	22
<b>5.3 Extra Information</b> .....	26
<b>5.4 AMI BIOS Beep Code</b> .....	28
<b>5.5 Troubleshooting</b> .....	29
<b>Appendix: SPEC In Other Languages</b> .....	<b>30</b>
<b>German</b> .....	30
<b>French</b> .....	32
<b>Italian</b> .....	34
<b>Spanish</b> .....	36
<b>Portuguese</b> .....	38
<b>Polish</b> .....	40
<b>Russian</b> .....	42
<b>Arabic</b> .....	44
<b>Japanese</b> .....	46

## **CHAPTER 1: INTRODUCTION**

### **1.1 BEFORE YOU START**

Thank you for choosing our product. Before you start installing the motherboard, please make sure you follow the instructions below:

- Prepare a dry and stable working environment with sufficient lighting.
- Always disconnect the computer from power outlet before operation.
- Before you take the motherboard out from anti-static bag, ground yourself properly by touching any safely grounded appliance, or use grounded wrist strap to remove the static charge.
- Avoid touching the components on motherboard or the rear side of the board unless necessary. Hold the board on the edge, do not try to bend or flex the board.
- Do not leave any unfastened small parts inside the case after installation. Loose parts will cause short circuits which may damage the equipment.
- Keep the computer from dangerous area, such as heat source, humid air and water.
- The operating temperatures of the computer should be 0 to 45 degrees Celsius.

### **1.2 PACKAGE CHECKLIST**

- ✚ HDD Cable X 1 (optional)
- ✚ Serial ATA Cable X 2
- ✚ Rear I/O Panel for ATX Case X 1
- ✚ Installation Guide X 1
- ✚ Fully Setup Driver CD X 1 (full version manual files inside)
- ✚ FDD Cable X 1 (optional)
- ✚ USB 2.0 Cable X1 (optional)
- ✚ Serial ATA Power Cable X 1 (optional)

**Note:** The package contents may be different due to area or your motherboard version.

### 1.3 MOTHERBOARD FEATURES

	<b>A880G+</b>	<b>A785G3+</b>
CPU	Socket AM3 AMD Phenom II/ Athlon II processors AMD 64 Architecture enables 32 and 64 bit computing Supports Hyper Transport 3.0 and Cool'n=Quiet (Maximum Watt: 125W)	Socket AM3 AMD Phenom II/ Athlon II processors AMD 64 Architecture enables 32 and 64 bit computing Supports Hyper Transport 3.0 and Cool'n=Quiet (Maximum Watt: 125W)
FSB	Support HyperTransport 3.0 Supports up to 5.2 GT/s Bandwidth	Support HyperTransport 3.0 Supports up to 5.2 GT/s Bandwidth
Chipset	AMD 880G AMD SB710	AMD 785G AMD SB710
Super I/O	ITE 8721 Provides the most commonly used legacy Super I/O functionality Low Pin Count Interface Environment Control initiatives H/W Monitor ITE's "Smart Guardian" function	ITE 8721 Provides the most commonly used legacy Super I/O functionality Low Pin Count Interface Environment Control initiatives H/W Monitor ITE's "Smart Guardian" function
Main Memory	DDR3 DIMM Slots x 2 Max Memory Capacity 8GB Each DIMM supports 512MB/1GB/2GB/4GB DDR3 Dual Channel Mode DDR3 memory module Supports DDR3 800 / 1066 / 1333 Registered DIMM and ECC DIMM is not supported	DDR3 DIMM Slots x 2 Max Memory Capacity 8GB Each DIMM supports 512MB/1GB/2GB/4GB DDR3 Dual Channel Mode DDR3 memory module Supports DDR3 800 / 1066 / 1333 Registered DIMM and ECC DIMM is not supported
Graphics	Integrated in AMD 880G Chipset Max Shared Video Memory is 512MB DVI/HDMI/HDCP/UVD2 support	Integrated in AMD 785G Chipset Max Shared Video Memory is 512MB DVI/HDMI/HDCP/UVD2 support
IDE	Integrated IDE Controller Ultra DMA 33 / 66 / 100 / 133 Bus Master Mode supports PIO Mode 0~4,	Integrated IDE Controller Ultra DMA 33 / 66 / 100 / 133 Bus Master Mode supports PIO Mode 0~4,
SATA II	Integrated Serial ATA Controller Data transfer rates up to 3 Gb/s SATA Version 2.0 specification compliant	Integrated Serial ATA Controller Data transfer rates up to 3 Gb/s SATA Version 2.0 specification compliant
LAN	Realtek RTL 8111DL 10 / 100 / 1000 Mb/s auto negotiation Half / Full duplex capability	Realtek RTL 8111DL 10 / 100 / 1000 Mb/s auto negotiation Half / Full duplex capability
Sound	ALC662 5.1 channels audio out High Definition Audio	ALC662 5.1 channels audio out High Definition Audio
Slots	PCI Express Gen2 x16 slot           x1 PCI slot                                   x2	PCI Express Gen2 x16 slot           x1 PCI slot                                   x2

	<b>A880G+</b>	<b>A785G3+</b>		
On Board Connector	Floppy Connector	x1	Floppy Connector	x1
	IDE Connector	x1	IDE Connector	x1
	SATA Connector	x4	SATA Connector	x4
	Front Panel Connector	x1	Front Panel Connector	x1
	Front Audio Connector	x1	Front Audio Connector	x1
	S/PDIF Out Connector	x1	S/PDIF Out Connector	x1
	CPU Fan Header	x1	CPU Fan Header	x1
	System Fan Header	x1	System Fan Header	x1
	CMOS clear Header	x1	CMOS clear Header	x1
	USB Connector	x2	USB Connector	x2
	Power Connector (24pin)	x1	Power Connector (24pin)	x1
	Power Connector (4pin)	x1	Power Connector (4pin)	x1
	Consumer IR Connector	x1	Consumer IR Connector	x1
	Printer Port Connector	x1	Printer Port Connector	x1
	Serial port Connector	x1	Serial port Connector	x1
	Back Panel I/O	PS/2 Keyboard / Mouse	x1	PS/2 Keyboard / Mouse
HDMI Port		x1	HDMI Port	x1
VGA Port		x1	VGA Port	x1
DVI-D Port		x1	DVI-D Port	x1
LAN Port		x1	LAN Port	x1
USB Port		x4	USB Port	x4
Audio Jack		x3	Audio Jack	x3
Board Size	200 mm(W) x 244 mm(L)	200 mm(W) x 244 mm(L)		
Special Features	RAID 0 / 1 / 1+0 support	RAID 0 / 1 / 1+0 support		
OS Support	Windows XP / Vista / 7 Biostar reserves the right to add or remove support for any OS With or without notice.	Windows XP / Vista / 7 Biostar reserves the right to add or remove support for any OS With or without notice.		

### 1.4 REAR PANEL CONNECTORS

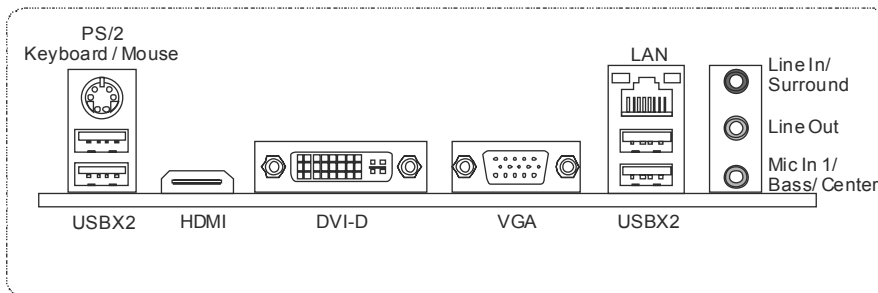

**NOTE:** The HDMI and DVI-D ports both can provide digital video signals out-put function, but these two interfaces cannot work at the same time. The chipset uses the same channel to control HDMI and DVI-D, so these ports cannot transmit video signal to different display panels simultaneously.

## 1.5 MOTHERBOARD LAYOUT

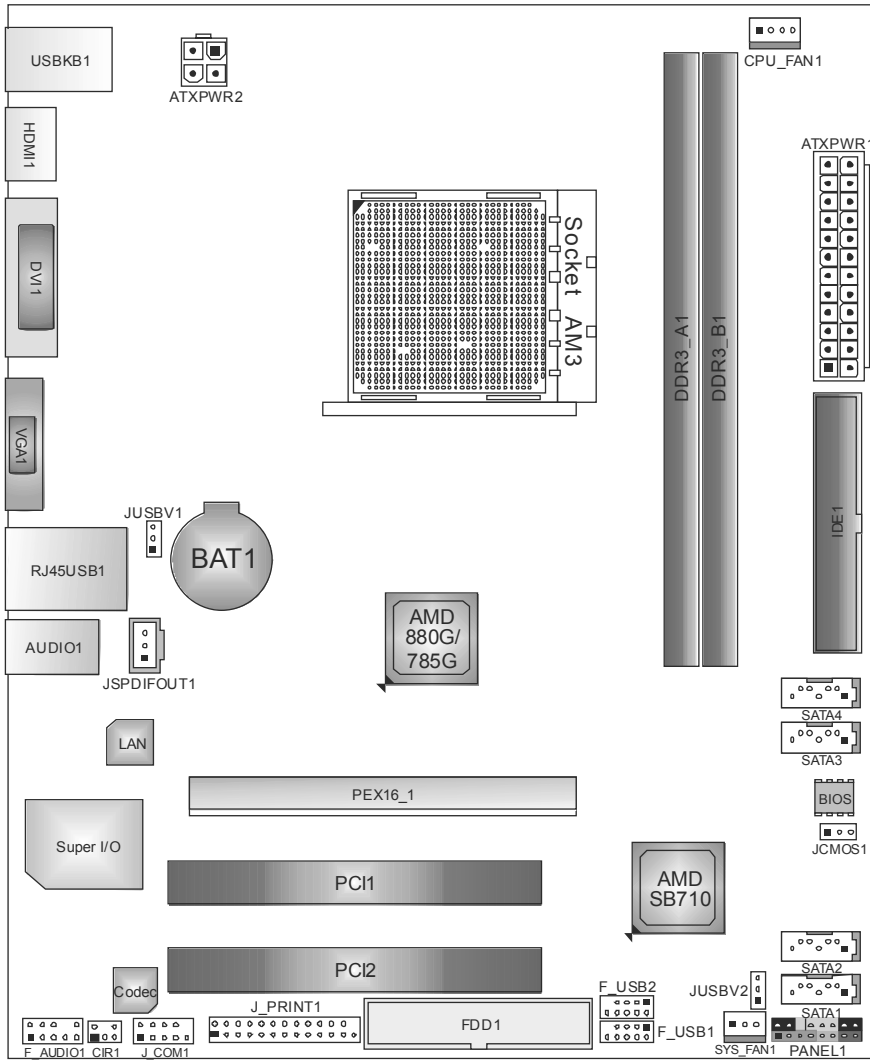

**Note:** ■ represents the 1<sup>st</sup> pin.

## **CHAPTER 2: HARDWARE INSTALLATION**

### **2.1 INSTALLING CENTRAL PROCESSING UNIT (CPU)**

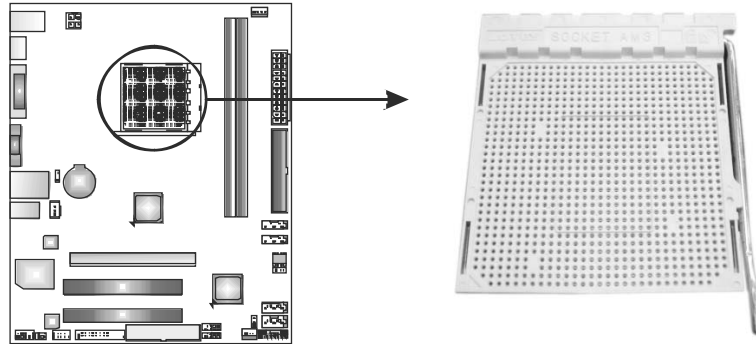

**Step 1:** Pull the lever toward direction A from the socket and then raise the lever up to a 90-degree angle.

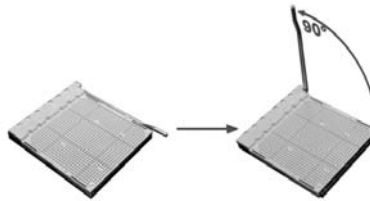

**Step 2:** Look for the white triangle on socket, and the gold triangle on CPU should point towards this white triangle. The CPU will fit only in the correct orientation.



## Motherboard Manual

---

**Step 3:** Hold the CPU down firmly, and then close the lever toward direct B to complete the installation.

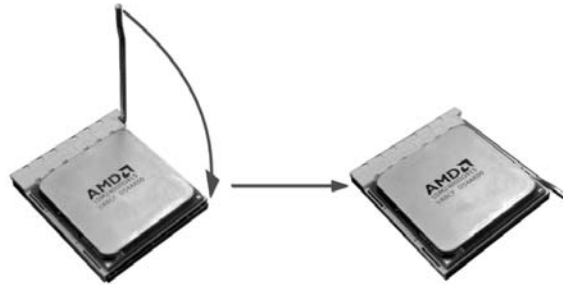

**Step 4:** Put the CPU Fan on the CPU and buckle it. Connect the CPU FAN power cable to the CPU\_FAN1. This completes the installation.



## 2.2 FAN HEADERS

These fan headers support cooling-fans built in the computer. The fan cable and connector may be different according to the fan manufacturer. Connect the fan cable to the connector while matching the black wire to pin#1.

### CPU\_FAN1: CPU Fan Header

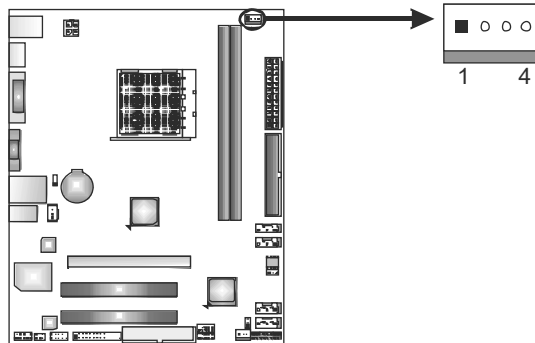

Pin	Assignment
1	Ground
2	+12V
3	FAN RPM rate sense
4	Smart Fan Control (By Fan)

### SYS\_FAN1: System Fan Header

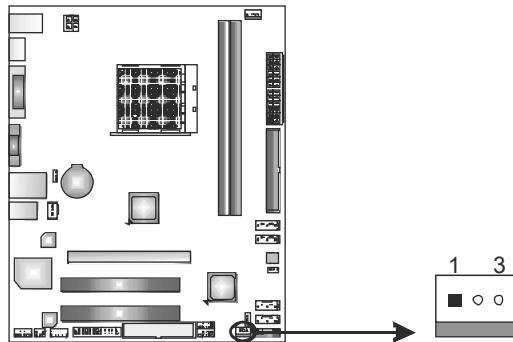

Pin	Assignment
1	Ground
2	+12V
3	FAN RPM rate sense

**Note:**

CPU\_FAN1 supports 4-pin head connector. SYS\_FAN1 supports 3-pin head connector. When connecting with wires onto connectors, please note that the red wire is the positive and should be connected to pin#2, and the black wire is Ground and should be connected to GND.

## 2.3 INSTALLING SYSTEM MEMORY

### A. Memory Modules

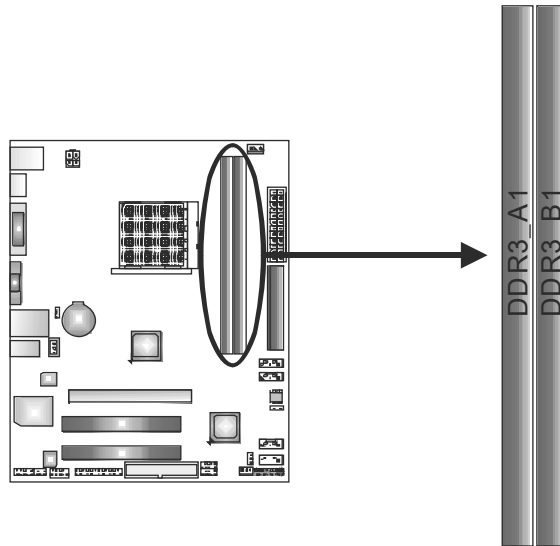

1. Unlock a DIMM slot by pressing the retaining clips outward. Align a DIMM on the slot such that the notch on the DIMM matches the break on the Slot.

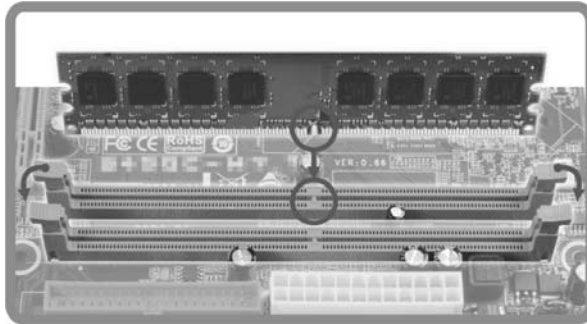

2. Insert the DIMM vertically and firmly into the slot until the retaining chip snap back in place and the DIMM is properly seated.

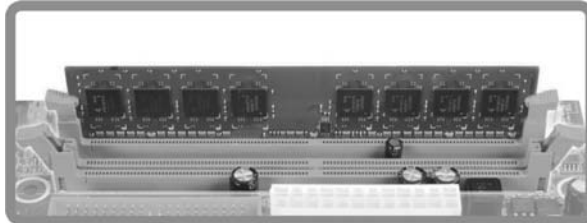

**B. Memory Capacity**

DIMM Socket Location	DDR3 Module	Total Memory Size
DDR3_A1	512MB/1GB/2GB/4GB	Max is 8GB.
DDR3_B1	512MB/1GB/2GB/4GB	

**C. Dual Channel Memory installation**

Please refer to the following requirements to activate Dual Channel function:

Install memory module of the same density in pairs, shown in the table

Dual Channel Status	DDR3_A1	DDR3_B1
Disabled	X	O
Disabled	O	X
Enabled	O	O

(O means memory installed, X means memory not installed.)

The DRAM bus width of the memory module must be the same (x8 or x16)

## 2.4 CONNECTORS AND SLOTS

### FDD1: Floppy Disk Connector

The motherboard provides a standard floppy disk connector that supports 360K, 720K, 1.2M, 1.44M and 2.88M floppy disk types.

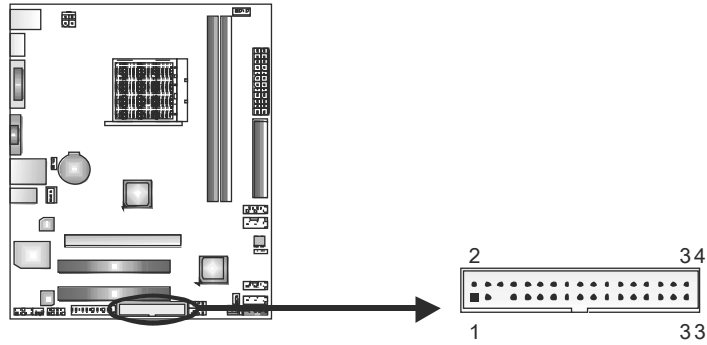

### IDE1: Hard Disk Connector

The motherboard has a 32-bit Enhanced PCI IDE Controller that provides PIO Mode 0~4, Bus Master, and Ultra DMA 33/66/100/133 functionality.

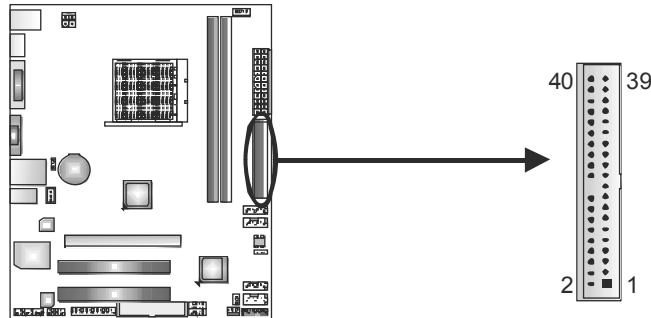

### SATA1~SATA4: Serial ATA Connectors

The motherboard has a PCI to SATA Controller with 4 channels SATA interface, it satisfies the SATA 2.0 spec and with transfer rate of 3.0Gb/s.

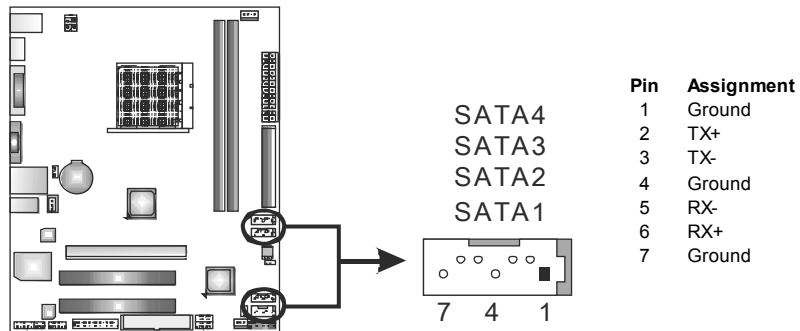

**ATXPWR1: ATX Power Source Connector**

This connector allows user to connect 24-pin power connector on the ATX power supply.

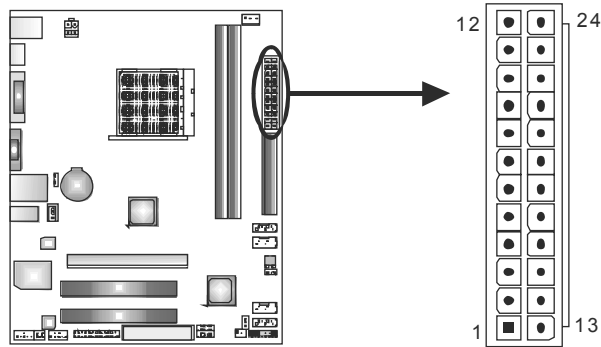

Pin	Assignment	Pin	Assignment
13	+3.3V	1	+3.3V
14	-12V	2	+3.3V
15	Ground	3	Ground
16	PS_ON	4	+5V
17	Ground	5	Ground
18	Ground	6	+5V
19	Ground	7	Ground
20	NC	8	PW_OK
21	+5V	9	Standby Voltage+5V
22	+5V	10	+12V
23	+5V	11	+12V
24	Ground	12	+3.3V

**ATXPWR2: ATX Power Source Connector**

Connecting this connector will provide +12V to CPU power circuit.

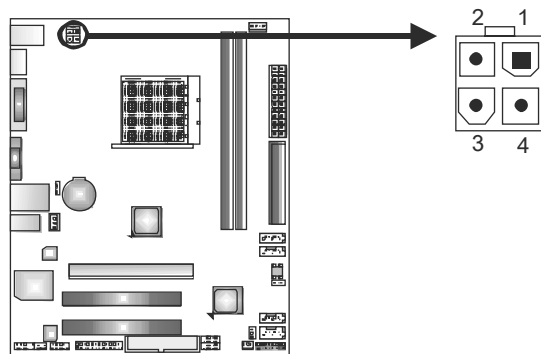

Pin	Assignment
1	+12V
2	+12V
3	Ground
4	Ground

**Note:**

Before you power on the system, please make sure that both ATXPWR1 and ATXPWR2 connectors have been plugged-in.

**PEX16\_1: PCI-Express Gen2 x16 Slot**

- PCI-Express 2.0 compliant.
- Maximum theoretical realized bandwidth of 8GB/s simultaneously per direction, for an aggregate of 16GB/s totally.

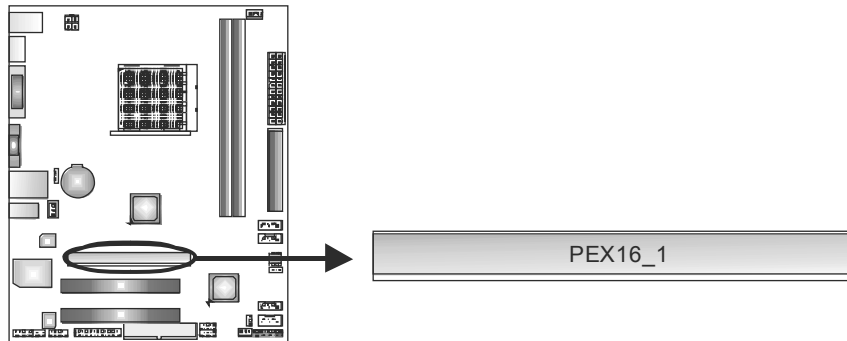

**PCI1~PCI2: Peripheral Component Interconnect Slots**

This motherboard is equipped with 2 standard PCI slots. PCI stands for Peripheral Component Interconnect, and it is a bus standard for expansion cards. This PCI slot is designated as 32 bits.

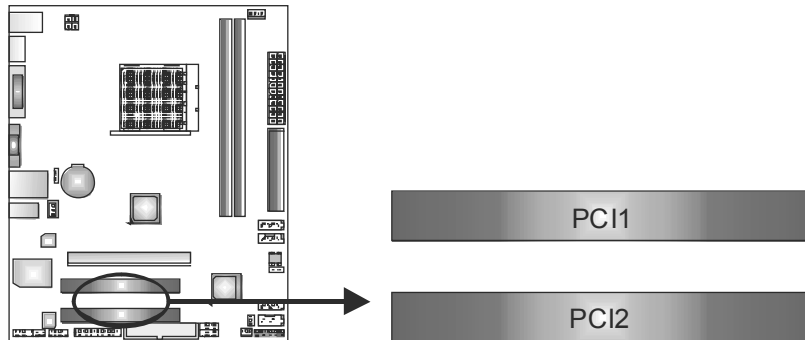

## CHAPTER 3: HEADERS & JUMPERS SETUP

### 3.1 HOW TO SETUP JUMPERS

The illustration shows how to set up jumpers. When the jumper cap is placed on pins, the jumper is “close”, if not, that means the jumper is “open”.

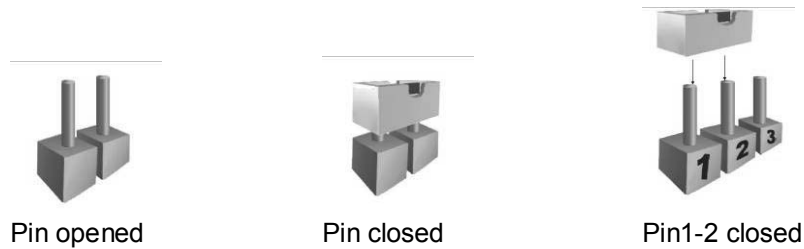

### 3.2 DETAIL SETTINGS

#### PANEL1: Front Panel Header

This 16-pin connector includes Power-on, Reset, HDD LED, Power LED, and speaker connection. It allows user to connect the PC case's front panel switch functions.

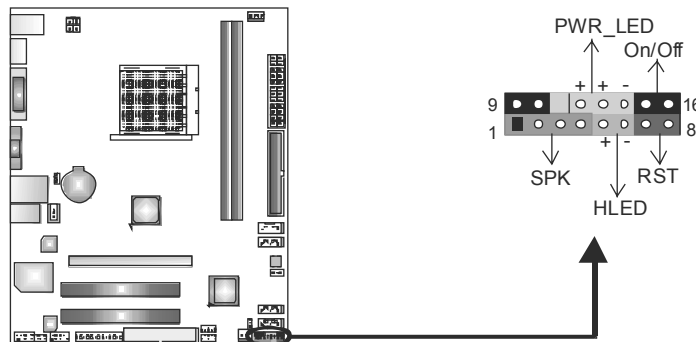

Pin	Assignment	Function	Pin	Assignment	Function
1	+5V	Speaker Connector	9	N/A	N/A
2	N/A		10	N/A	
3	N/A		11	N/A	
4	Speaker	Hard drive LED	12	Power LED (+)	Power LED
5	HDD LED (+)		13	Power LED (+)	
6	HDD LED (-)		14	Power LED (-)	
7	Ground	Reset button	15	Power button	Power-on button
8	Reset control		16	Ground	

### F\_USB1/F\_USB2: Headers for USB 2.0 Ports at Front Panel

This header allows user to connect additional USB cable on the PC front panel, and also can be connected with internal USB devices, like USB card reader.

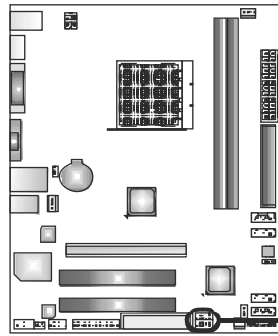

Pin	Assignment
1	+5V (fused)
2	+5V (fused)
3	USB-
4	USB-
5	USB+
6	USB+
7	Ground
8	Ground
9	NC
10	Key

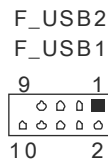

### JUSBV1/JUSBV2: Power Source Headers for USB Ports

**Pin 1-2 Close:**

JUSBV1: +5V for USB ports at USBKB1/RJ45USB1.

JUSBV2: +5V for USB ports at F\_USB1/F\_USB2.

**Pin 2-3 Close:**

JUSBV1: +5V STB for USB ports at USBKB1/RJ45USB1.

JUSBV2: +5V STB for USB ports at F\_USB1/F\_USB2.

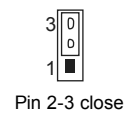
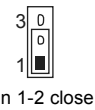
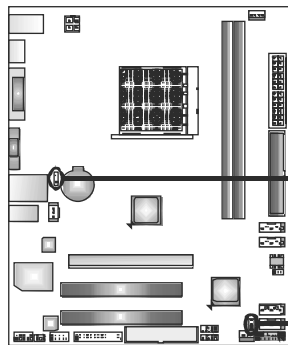



**JSPDIFOUT1: Digital Audio-out Connector**

This connector allows user to connect the PCI bracket SPDIF output header.

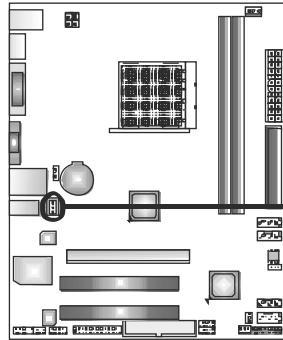

Pin	Assignment
1	+5V
2	SPDIF_OUT
3	Ground



**F\_AUDIO1: Front Panel Audio Header**

This header allows user to connect the front audio output cable with the PC front panel. This header allows only HD audio front panel connector; AC'97 connector is not acceptable.

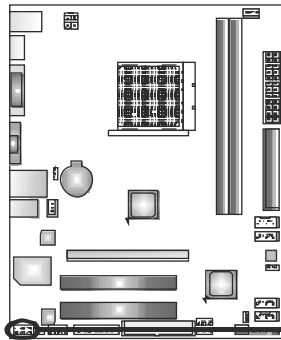

Pin	Assignment
1	Mic Left in
2	Ground
3	Mic Right in
4	GPIO
5	Right line in
6	Jack Sense
7	Front Sense
8	Key
9	Left line in
10	Jack Sense

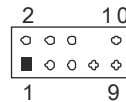

### JCMOS1: Clear CMOS Header

Placing the jumper on pin2-3, it allows user to restore the BIOS safe setting and the CMOS data. Please carefully follow the procedures to avoid damaging the motherboard.

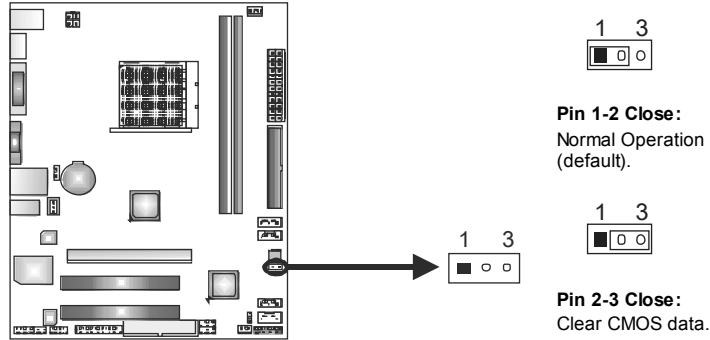

#### ※ Clear CMOS Procedures:

1. Remove AC power line.
2. Set the jumper to "Pin 2-3 close".
3. Wait for five seconds.
4. Set the jumper to "Pin 1-2 close".
5. Power on the AC.
6. Reset your desired password or clear the CMOS data.

### J\_COM1: Serial Port Connector

The motherboard has a Serial Port Connector for connecting RS-232 Port.

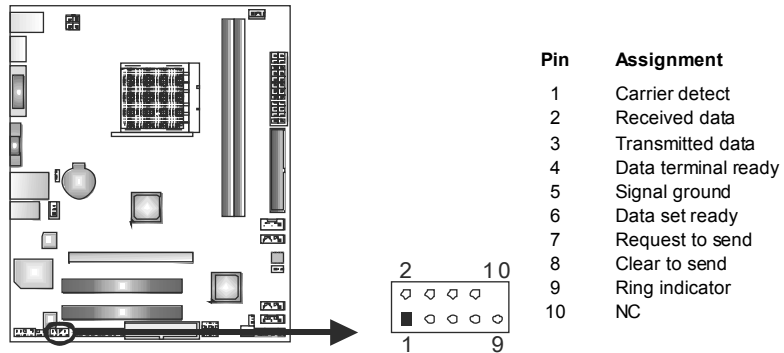

**J\_PRINT1: Printer Port Connector**

This header allows you to connector printer on the PC.

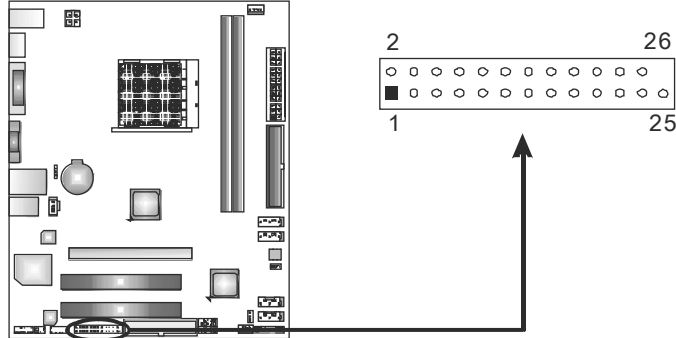

Pin	Assignment	Pin	Assignment
1	-Strobe	14	Ground
2	-ALF	15	Data 6
3	Data 0	16	Ground
4	-Error	17	Data 7
5	Data 1	18	Ground
6	-Init	19	-ACK
7	Data 2	20	Ground
8	-Scltin	21	Busy
9	Data 3	22	Ground
10	Ground	23	PE
11	Data 4	24	Ground
12	Ground	25	SCLT
13	Data 5	26	Key

**CIR1: Consumer IR Connector**

This header is for infrared remote control and communication.

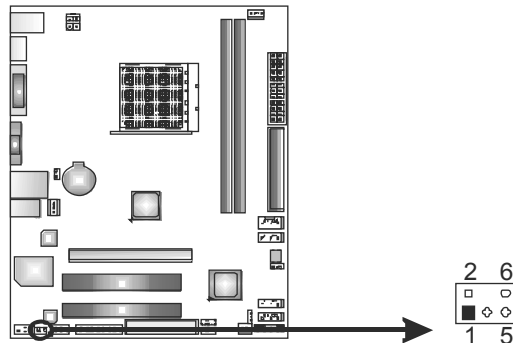

Pin	Assignment
1	IrDA serial input
2	Ground
3	Ground
4	Key
5	IrDA serial output
6	IR Power

## CHAPTER 4: RAID FUNCTIONS

### 4.1 OPERATING SYSTEM

Supports Windows XP, Windows Vista, and Windows 7.

### 4.2 RAID ARRAYS

RAID supports the following types of RAID arrays:

**RAID 0:** RAID 0 defines a disk striping scheme that improves disk read and write times for many applications.

**RAID 1:** RAID 1 defines techniques for mirroring data.

**RAID 1+0:** RAID 1+0 combines the techniques used in RAID 0 and RAID 1.

### 4.3 How RAID WORKS

#### RAID 0:

The controller “stripes” data across multiple drives in a RAID 0 array system. It breaks up a large file into smaller blocks and performs disk reads and writes across multiple drives in parallel. The size of each block is determined by the stripe size parameter, which you set during the creation of the RAID set based on the system environment. This technique reduces overall disk access time and offers high bandwidth.

#### Features and Benefits

- **Drives:** Minimum 2, and maximum is up to 6 or 8. Depending on the platform.
- **Uses:** Intended for non-critical data requiring high data throughput, or any environment that does not require fault tolerance.
- **Benefits:** provides increased data throughput, especially for large files. No capacity loss penalty for parity.
- **Drawbacks:** Does not deliver any fault tolerance. If any drive in the array fails, all data is lost.
- **Fault Tolerance:** No.

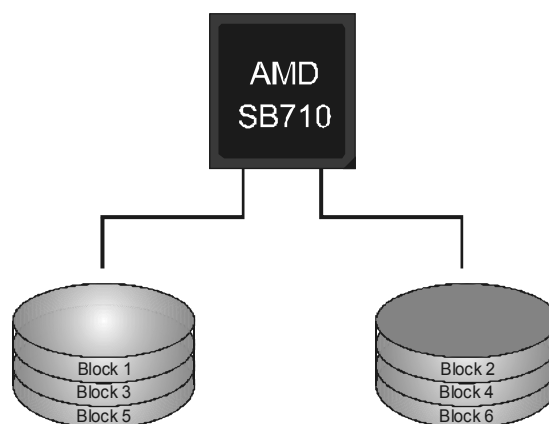

**RAID 1:**

Every read and write is actually carried out in parallel across 2 disk drives in a RAID 1 array system. The mirrored (backup) copy of the data can reside on the same disk or on a second redundant drive in the array. RAID 1 provides a hot-standby copy of data if the active volume or drive is corrupted or becomes unavailable because of a hardware failure.

RAID techniques can be applied for high-availability solutions, or as a form of automatic backup that eliminates tedious manual backups to more expensive and less reliable media.

**Features and Benefits**

- **Drives:** Minimum 2, and maximum is 2.
- **Uses:** RAID 1 is ideal for small databases or any other application that requires fault tolerance and minimal capacity.
- **Benefits:** Provides 100% data redundancy. Should one drive fail, the controller switches to the other drive.
- **Drawbacks:** Requires 2 drives for the storage space of one drive. Performance is impaired during drive rebuilds.
- **Fault Tolerance:** Yes.

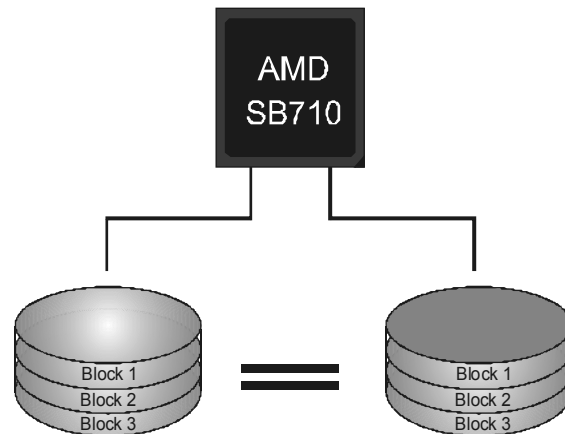

**RAID 1+0:**

RAID 1 drives can be striped using RAID 0 techniques. Resulting in a RAID 1+0 solution for improved resiliency, performance and rebuild performance.

**Features and Benefits**

- **Drives:** Minimum 4, and maximum is 6 or 8, depending on the platform.
- **Benefits:** Optimizes for both fault tolerance and performance, allowing for automatic redundancy. May be simultaneously used with other RAID levels in an array, and allows for spare disks.
- **Drawbacks:** Requires twice the available disk space for data redundancy, the same as RAID level 1.
- **Fault Tolerance:** Yes.

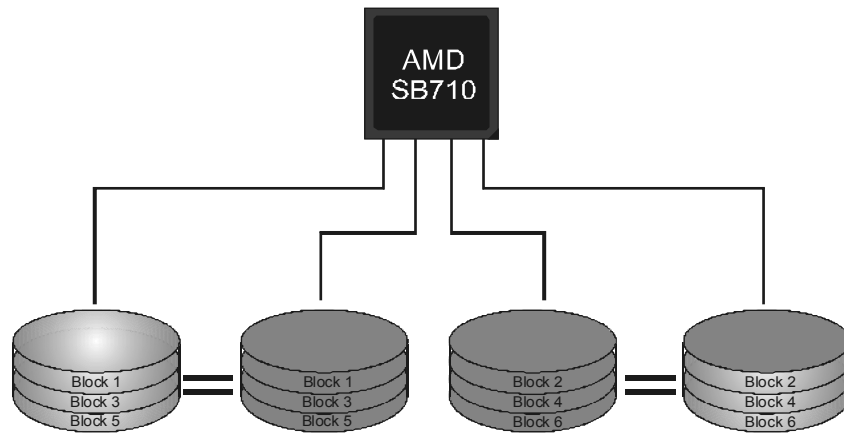

## CHAPTER 5: USEFUL HELP

### 5.1 DRIVER INSTALLATION NOTE

After you installed your operating system, please insert the Fully Setup Driver CD into your optical drive and install the driver for better system performance.

You will see the following window after you insert the CD



The setup guide will auto detect your motherboard and operating system.

**Note:**

If this window didn't show up after you insert the Driver CD, please use file browser to locate and execute the file **SETUP.EXE** under your optical drive.

#### A. Driver Installation

To install the driver, please click on the Driver icon. The setup guide will list the compatible driver for your motherboard and operating system. Click on each device driver to launch the installation program.

#### B. Software Installation

To install the software, please click on the Software icon. The setup guide will list the software available for your system, click on each software title to launch the installation program.

#### C. Manual

Aside from the paperback manual, we also provide manual in the Driver CD. Click on the Manual icon to browse for available manual.

**Note:**

You will need Acrobat Reader to open the manual file. Please download the latest version of Acrobat Reader software from <http://www.adobe.com/products/acrobat/readstep2.html>

## 5.2 SOFTWARE

### Installing Software

1. Insert the Setup CD to the optical drive. The drivers installation program would appear if the Autorun function has been enabled.
2. Select **Software Installation**, and then click on the respective software title.
3. Follow the on-screen instructions to complete the installation.

### Launching Software

After the installation process, you will see the software icon “eHOT Line” / “BIOS Update” appears on the desktop. Double-click the icon to launch the utility.

### eHot-Line (Optional)

eHot-Line is a convenient utility that helps you to contact with our Tech-Support system. This utility will collect the system information which is useful for analyzing the problem you may have encountered, and then send these information to our tech-support department to help you fix the problem.

 Before you use this utility, please set Outlook Express as your default e-mail client application program.

\*represents important information that you must provide. Without this information, you may not be able to send out the mail.

This block will show the information which would be collected in the mail.

\*Describe condition of your system.

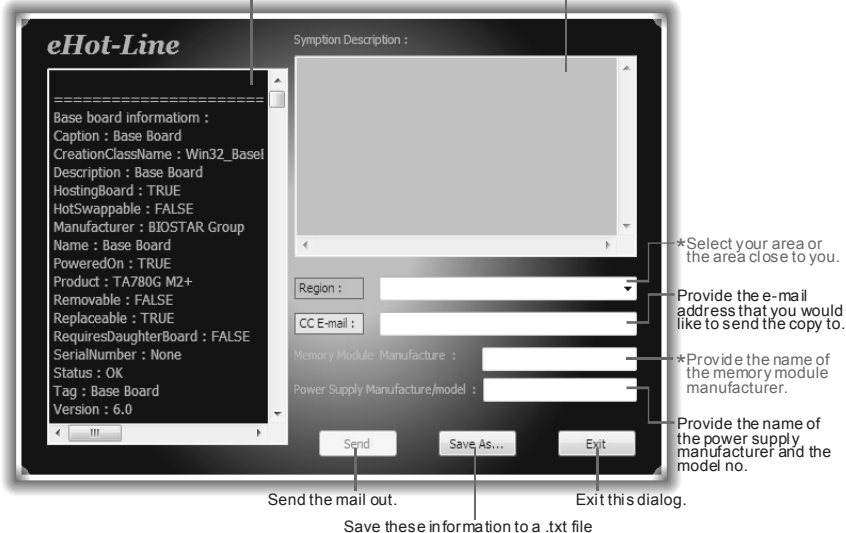

The screenshot shows the eHot-Line utility window. On the left, a text area displays system information: Base board information: Caption: Base Board, CreationClassName: Win32\_Base, Description: Base Board, HostingBoard: TRUE, HotSwappable: FALSE, Manufacturer: BIOSTAR Group, Name: Base Board, PoweredOn: TRUE, Product: TA780G M2+, Removable: FALSE, Replaceable: TRUE, RequiresDaughterBoard: FALSE, SerialNumber: None, Status: OK, Tag: Base Board, Version: 6.0. On the right, there is a 'Symptom Description' text area. Below it are input fields for 'Region', 'CC E-mail', 'Memory Module Manufacture', and 'Power Supply Manufacture/model'. At the bottom are 'Send', 'Save As...', and 'Exit' buttons. Annotations with arrows point to various parts of the interface: the system information list, the Symptom Description area, the Region dropdown, the CC E-mail field, the Memory Module Manufacture field, the Power Supply Manufacture/model field, the Send button, the Save As... button, and the Exit button.

\*Select your area or the area close to you.

Provide the e-mail address that you would like to send the copy to.

\*Provide the name of the memory module manufacturer.

Provide the name of the power supply manufacturer and the model no.

Send the mail out.

Save these information to a .txt file

Exit this dialog.



After filling up this information, click **“Send”** to send the mail out. A warning dialog would appear asking for your confirmation; click **“Send”** to confirm or **“Do Not Send”** to cancel.



If you want to save this information to a .txt file, click **“Save As...”** and then you will see a saving dialog appears asking you to enter file name.

Enter the file name and then click **“Save”**. Your system information will be saved to a .txt file.

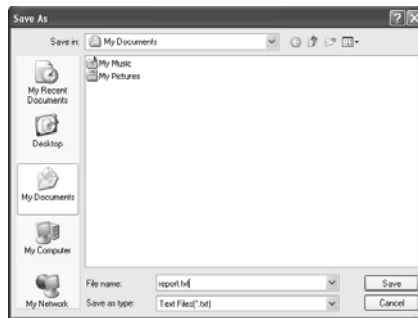

Open the saved .txt file, you will see your system information including motherboard/BIOS/CPU/video/device/OS information. This information is also concluded in the sent mail.



**We will not share customer’s data with any other third parties,** so please feel free to provide your system information while using eHot-Line service.



If you are not using Outlook Express as your default e-mail client application, you may need to save the system information to a .txt file and send the file to our tech support with other e-mail application. Go to the following web <http://www.biostar.com.tw/app/en-us/about/contact.php> for getting our contact information.

## BIOS Update

BIOS Update is a convenient utility which allows you to update your motherboard BIOS under Windows system.

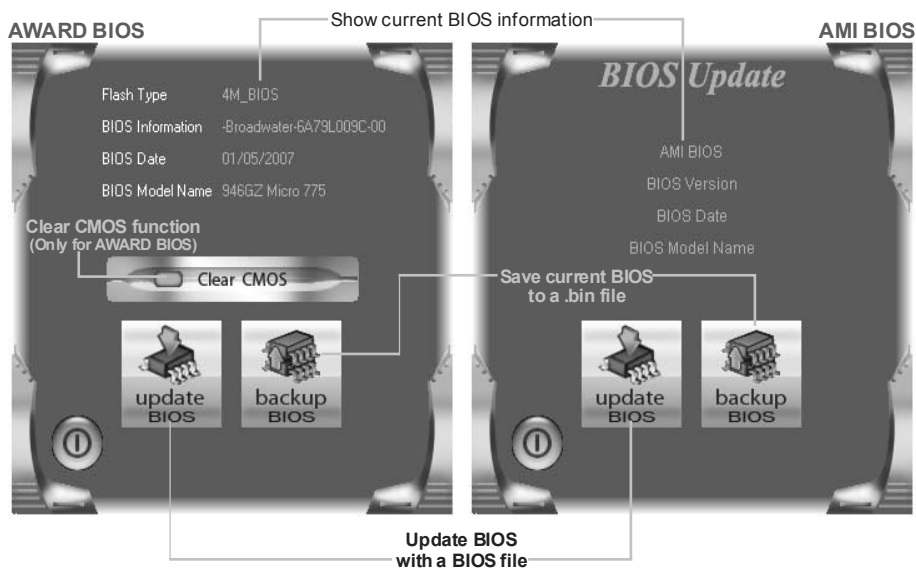

### <Backup BIOS>

Once click on this button, the saving dialog will show. Choose the position to save file and enter file name. (We recommend that the file name should be English/number and no longer than 7 characters.) Then click **Save**.

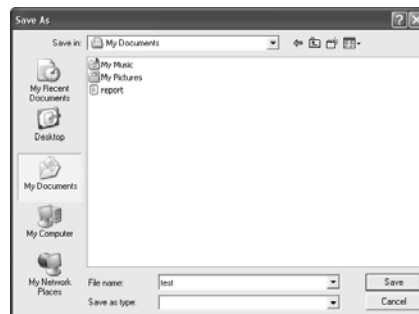

<Update BIOS>

Before doing this, please download the proper BIOS file from the website.

For AWARD BIOS, update BIOS procedure should be run with Clear CMOS function, so please check on Clear CMOS first.

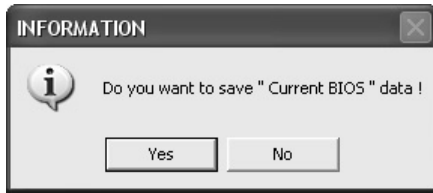
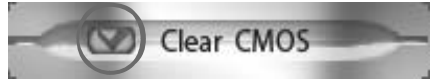

Then click Update BIOS button, a dialog will show for asking you backup current BIOS. Click **Yes** for BIOS backup and refer to the Backup BIOS procedure; or click **No** to skip this procedure.

After the BIOS Backup procedure, the open dialog will show for requesting the BIOS file which is going to be updated. Please choose the proper BIOS file for updating, then click on **Open**.

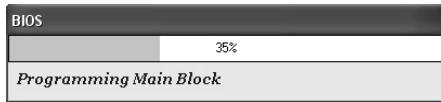
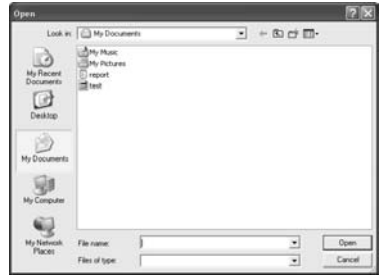

The utility will update BIOS with the proper BIOS file, and this process may take minutes. Please do not open any other applications during this process.

After the BIOS Update process, click on **OK** to restart the system.

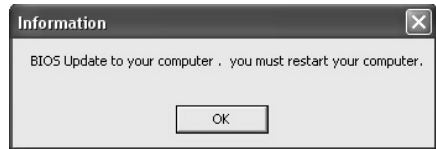

While the system boots up and the full screen logo shows, press  <Delete> key to enter BIOS setup.

In the BIOS setup, use the **Load Optimized Defaults** function and then **Save and Exit Setup** to exit BIOS setup. BIOS Update is completed.



All the information and content above about the software are subject to be changed without notice. For better performance, the software is being continuously updated. The information and pictures described above are for your reference only. The actual information and settings on board may be slightly different from this manual.

### 5.3 EXTRA INFORMATION

#### ***CPU Overheated***

If the system shutdown automatically after power on system for seconds, that means the CPU protection function has been activated.

When the CPU is over heated, the motherboard will shutdown automatically to avoid a damage of the CPU, and the system may not power on again.

In this case, please double check:

1. The CPU cooler surface is placed evenly with the CPU surface.
2. CPU fan is rotated normally.
3. CPU fan speed is fulfilling with the CPU speed.

After confirmed, please follow steps below to relief the CPU protection function.

1. Remove the power cord from power supply for seconds.
2. Wait for seconds.
3. Plug in the power cord and boot up the system.

Or you can:

1. Clear the CMOS data.  
(See "Close CMOS Header: JCMOS1" section)
2. Wait for seconds.
3. Power on the system again.

## BIO-Flasher

BIO-Flasher is a BIOS flashing utility providing you an easy and simple way to update your BIOS via USB pen drive or floppy disk.

The BIO-Flasher is built in the BIOS chip. To enter the utility, **press <F12> during the Power-On Self Tests (POST)** procedure while booting up.

### Updating BIOS with BIO-Flasher

1. Go to the website to download the latest BIOS file for the motherboard.
2. Then, save the BIOS file into a USB pen drive or a floppy disk.
3. Insert the USB pen drive or the floppy disk that contains the BIOS file to the USB port or the floppy disk drive.
4. Power on or reset the computer and then press **<F12>** during the **POST** process. A select dialog as the picture on the right appears. Select the device contains the BIOS file and press **<Enter>** to enter the utility.



5. The utility will show the BIOS files and their respective information. Select the proper BIOS file and press **<Enter>** then **<Y>** to perform the BIOS update process.

6. After the update process, the utility will ask you to reboot the system. Press **<Y>** to proceed. BIOS update completes.



- This utility only allows storage device with FAT32/16 format and single partition.
- Shutting down or resetting the system while updating the BIOS will lead to system boot failure.

## 5.4 AMI BIOS BEEP CODE

### Boot Block Beep Codes

Number of Beeps	Description
1	No media present. (Insert diskette in floppy drive A:)
2	"AMIBOOT.ROM" file not found in root directory of diskette in A:
3	Insert next diskette if multiple diskettes are used for recovery
4	Flash Programming successful
5	File read error
7	No Flash EPROM detected
10	Flash Erase error
11	Flash Program error
12	"AMIBOOT.ROM" file size error
13	BIOS ROM image mismatch (file layout does not match image present in flash device)

### POST BIOS Beep Codes

Number of Beeps	Description
1	Memory refresh timer error
3	Base memory read/write test error
6	Keyboard controller BAT command failed
7	General exception error (processor exception interrupt error)
8	Display memory error (system video adapter)

### Troubleshooting POST BIOS Beep Codes

Number of Beeps	Troubleshooting Action
1, 3	Reseat the memory, or replace with known good modules.
6, 7	<p>Fatal error indicating a serious problem with the system. Consult your system manufacturer. Before declaring the motherboard beyond all hope, eliminate the possibility of interference by a malfunctioning add-in card. Remove all expansion cards except the video adapter.</p> <ul style="list-style-type: none"> <li>● If beep codes are generated when all other expansion cards are absent, consult your system manufacturer's technical support.</li> <li>● If beep codes are not generated when all other expansion cards are absent, one of the add-in cards is causing the malfunction. Insert the cards back into the system one at a time until the problem happens again. This will reveal the malfunctioning card.</li> </ul>
8	If the system video adapter is an add-in card, replace or reseat the video adapter. If the video adapter is an integrated part of the system board, the board may be faulty.

## 5.5 TROUBLESHOOTING

Probable	Solution
<ol style="list-style-type: none"> <li>1. There is no power in the system. Power LED does not shine; the fan of the power supply does not work</li> <li>2. Indicator light on keyboard does not shine.</li> </ol>	<ol style="list-style-type: none"> <li>1. Make sure power cable is securely plugged in.</li> <li>2. Replace cable.</li> <li>3. Contact technical support.</li> </ol>
System is inoperative. Keyboard lights are on, power indicator lights are lit, and hard drives are running.	Using even pressure on both ends of the DIMM, press down firmly until the module snaps into place.
System does not boot from a hard disk drive, but can be booted from optical drive.	<ol style="list-style-type: none"> <li>1. Check cable running from disk to disk controller board. Make sure both ends are securely plugged in; check the drive type in the standard CMOS setup.</li> <li>2. Backing up the hard drive is extremely important. All hard disks are capable of breaking down at any time.</li> </ol>
System only boots from an optical drive. Hard disks can be read, applications can be used, but system fails to boot from a hard disk.	<ol style="list-style-type: none"> <li>1. Back up data and applications files.</li> <li>2. Reformat the hard drive. Re-install applications and data using backup disks.</li> </ol>
Screen message shows "Invalid Configuration" or "CMOS Failure."	Review system's equipment. Make sure correct information is in setup.
System cannot boot after user installs a second hard drive.	<ol style="list-style-type: none"> <li>1. Set master/slave jumpers correctly.</li> <li>2. Run SETUP program and select correct drive types. Call the drive manufacturers for compatibility with other drives.</li> </ol>

**APPENDIX: SPEC IN OTHER LANGUAGES****GERMAN**

	<b>A880G+</b>	<b>A785G3+</b>
CPU	Sockel AM3 AMD Phenom II/ Athlon II Prozessoren Die AMD 64-Architektur unterstützt eine 32-Bit- und 64-Bit-Datenverarbeitung Unterstützt Hyper Transport 3.0 und Cool'n'Quiet (Maximales Watt: 125W)	Sockel AM3 AMD Phenom II/ Athlon II Prozessoren Die AMD 64-Architektur unterstützt eine 32-Bit- und 64-Bit-Datenverarbeitung Unterstützt Hyper Transport 3.0 und Cool'n'Quiet (Maximales Watt: 125W)
FSB	Unterstützt HyperTransport 3.0 mit einer Bandbreite von bis zu 5.2 GT/s	Unterstützt HyperTransport 3.0 mit einer Bandbreite von bis zu 5.2 GT/s
Chipsatz	AMD 880G AMD SB710	AMD 785G AMD SB710
Super E/A	ITE8721 Bietet die häufig verwendeten alten Super E/A-Funktionen. Low Pin Count-Schnittstelle Umgebungskontrolle, Hardware-Überwachung "Smart Guardian"-Funktion von ITE	ITE8721 Bietet die häufig verwendeten alten Super E/A-Funktionen. Low Pin Count-Schnittstelle Umgebungskontrolle, Hardware-Überwachung "Smart Guardian"-Funktion von ITE
Arbeitsspeicher	DDR3 DIMM-Steckplätze x 2 Max. 8GB Arbeitsspeicher Jeder DIMM unterstützt 512MB/ 1GB/2GB/4GB DDR3. Dual-Kanal DDR3 Speichermodul Unterstützt DDR3 800 / 1066 / 1333 registrierte DIMMs. ECC DIMMs werden nicht unterstützt.	DDR3 DIMM-Steckplätze x 2 Max. 8GB Arbeitsspeicher Jeder DIMM unterstützt 512MB/ 1GB/2GB/4GB DDR3. Dual-Kanal DDR3 Speichermodul Unterstützt DDR3 800 / 1066 / 1333 registrierte DIMMs. ECC DIMMs werden nicht unterstützt.
Grafik	Integrierter AMD 880G-Chipsatz Max. 512MB gemeinsam benutzter Videospeicher Unterstützt DVI/HDMI/HDPC/UVD2	Integrierter AMD 785G-Chipsatz Max. 512MB gemeinsam benutzter Videospeicher Unterstützt DVI/HDMI/HDPC/UVD2
IDE	Integrierter IDE-Controller Ultra DMA 33 / 66 / 100 / 133 Bus Master-Modus Unterstützt PIO-Modus 0~4,	Integrierter IDE-Controller Ultra DMA 33 / 66 / 100 / 133 Bus Master-Modus Unterstützt PIO-Modus 0~4,
SATA	Integrierter Serial ATA-Controller Datentransferrate bis zu 3 Gb/s Konform mit der SATA-Spezifikation Version 2.0.	Integrierter Serial ATA-Controller Datentransferrate bis zu 3 Gb/s Konform mit der SATA-Spezifikation Version 2.0.
LAN	Realtek RTL 8111DL 10 / 100 / 1000 Mb/s Auto-Negotiation Halb-/ Vollduplex-Funktion	Realtek RTL 8111DL 10 / 100 / 1000 Mb/s Auto-Negotiation Halb-/ Vollduplex-Funktion



**A880G+/A785G3+**

	<b>A880G+</b>	<b>A785G3+</b>
HD Audio-Unterstützung	ALC662 5.1-Kanal-Audioausgabe Unterstützt High-Definition Audio	ALC662 5.1-Kanal-Audioausgabe Unterstützt High-Definition Audio
Steckplätze	PCI Express Gen2 x16 Steckplatz x1 PCI-Steckplatz x2	PCI Express Gen2 x16 Steckplatz x1 PCI-Steckplatz x2
Onboard-Anschluss	Diskettenlaufwerkanschluss x1 IDE-Anschluss x1 SATA-Anschluss x4 Fronttafelanschluss x1 Front-Audioanschluss x1 S/PDIF- Ausgangsanschluss x1 CPU-Lüfter-Sockel x1 System-Lüfter-Sockel x1 "CMOS löschen"-Sockel x1 USB-Anschluss x2 Stromanschluss (24-polig) x1 Stromanschluss (4-polig) x1 Verbraucher-IR Anschluss x1 Druckeranschluss Anschluss x1 Serieller Anschluss x1	Diskettenlaufwerkanschluss x1 IDE-Anschluss x1 SATA-Anschluss x4 Fronttafelanschluss x1 Front-Audioanschluss x1 S/PDIF- Ausgangsanschluss x1 CPU-Lüfter-Sockel x1 System-Lüfter-Sockel x1 "CMOS löschen"-Sockel x1 USB-Anschluss x2 Stromanschluss (24-polig) x1 Stromanschluss (4-polig) x1 Verbraucher-IR Anschluss x1 Druckeranschluss Anschluss x1 Serieller Anschluss x1
Rückseiten-E/A	PS/2-Tastatur / Maus x1 HDMI-Anschluss x1 VGA-Anschluss x1 DVI-D-Anschluss x1 LAN-Anschluss x1 USB-Anschluss x4 Audioanschluss x3	PS/2-Tastatur / Maus x1 HDMI-Anschluss x1 VGA-Anschluss x1 DVI-D-Anschluss x1 LAN-Anschluss x1 USB-Anschluss x4 Audioanschluss x3
Platinengröße	200 mm (B) X 244 mm (L)	200 mm (B) X 244 mm (L)
Sonderfunktionen	Unterstützt RAID 0 / 1 / 1+0	Unterstützt RAID 0 / 1 / 1+0
OS-Unterstützung	Windows XP / Vista / 7 Biostar behält sich das Recht vor, ohne Ankündigung die Unterstützung für ein Betriebssystem hinzuzufügen oder zu entfernen.	Windows XP / Vista / 7 Biostar behält sich das Recht vor, ohne Ankündigung die Unterstützung für ein Betriebssystem hinzuzufügen oder zu entfernen.

**FRENCH**

	<b>A880G+</b>	<b>A785G3+</b>
UC	Socket AM3 Processeurs AMD Phenom II/ Athlon II L'architecture AMD 64 permet le calcul 32 et 64 bits Prend en charge Hyper Transport 3.0 et Cool'n'Quiet (Watt maximum : 125W)	Socket AM3 Processeurs AMD Phenom II/ Athlon II L'architecture AMD 64 permet le calcul 32 et 64 bits Prend en charge Hyper Transport 3.0 et Cool'n'Quiet (Watt maximum : 125W)
Bus frontal	Prend en charge Hyper Transport 3.0 jusqu'à une bande passante de 5.2 GT/s	Prend en charge Hyper Transport 3.0 jusqu'à une bande passante de 5.2 GT/s
Chipset	AMD 880G AMD SB710	AMD 785G AMD SB710
Super E/S	ITE 8721 Fournit la fonctionnalité de Super E/S patrimoniales la plus utilisée. Interface à faible compte de broches Initiatives de contrôle environnementales, Moniteur de matériel Fonction "Gardien intelligent" de l'ITE	ITE 8721 Fournit la fonctionnalité de Super E/S patrimoniales la plus utilisée. Interface à faible compte de broches Initiatives de contrôle environnementales, Moniteur de matériel Fonction "Gardien intelligent" de l'ITE
Mémoire principale	Fentes DDR3 DIMM x 2 Capacité mémoire maximale de 8 Go Chaque DIMM prend en charge des DDR3 de 256 Mo/512 Mo et 1Go/2Go/4Go Module de mémoire DDR3 à mode à double voie Prend en charge la DDR3 800 / 1066 / 1333 Les DIMM à registres et DIMM avec code correcteurs d'erreurs ne sont pas prises en charge	Fentes DDR3 DIMM x 2 Capacité mémoire maximale de 8 Go Chaque DIMM prend en charge des DDR3 de 256 Mo/512 Mo et 1Go/2Go/4Go Module de mémoire DDR3 à mode à double voie Prend en charge la DDR3 800 / 1066 / 1333 Les DIMM à registres et DIMM avec code correcteurs d'erreurs ne sont pas prises en charge
Graphiques	Intégré dans la chipset AMD 880G Mémoire vidéo partagée maximale de 512 Mo Prise en charge DVI/HDMI/HDCP/UVD2	Intégré dans la chipset AMD 785G Mémoire vidéo partagée maximale de 512 Mo Prise en charge DVI/HDMI/HDCP/UVD2
IDE	Contrôleur IDE intégré Mode principale de Bus Ultra DMA 33 / 66 / 100 / 133 Prend en charge le mode PIO 0~4,	Contrôleur IDE intégré Mode principale de Bus Ultra DMA 33 / 66 / 100 / 133 Prend en charge le mode PIO 0~4,
SATA	Contrôleur Serial ATA intégré Taux de transfert jusqu'à 3 Go/s. Conforme à la spécification SATA Version 2.0	Contrôleur Serial ATA intégré Taux de transfert jusqu'à 3 Go/s. Conforme à la spécification SATA Version 2.0
LAN	Realtek RTL 8111DL 10 / 100 / 1000 Mb/s négociation automatique Half / Full duplex capability	Realtek RTL 8111DL 10 / 100 / 1000 Mb/s négociation automatique Half / Full duplex capability

**A880G+/A785G3+**

	<b>A880G+</b>	<b>A785G3+</b>
Prise en charge audio HD	ALC662 Sortie audio à 5.1 voies Prise en charge de l'audio haute définition	ALC662 Sortie audio à 5.1 voies Prise en charge de l'audio haute définition
Fentes	Fente PCI Express Gen2 x16 x1 Fente PCI x2	Fente PCI Express Gen2 x16 x1 Fente PCI x2
Connecteur embarqué	Connecteur de disquette x1 Connecteur IDE x1 Connecteur SATA x4 Connecteur du panneau avant x1 Connecteur Audio du panneau avant x1 Connecteur de sortie S/PDIF x1 Embase de ventilateur UC x1 Embase de ventilateur système x1 Embase d'effacement CMOS x1 Connecteur USB x2 Connecteur d'alimentation x1 (24 broches) Connecteur d'alimentation x1 (4 broches) Connecteur de IR du consommateur x1 Connecteur de Port d'imprimante x1 Connecteur de Port série x1	Connecteur de disquette x1 Connecteur IDE x1 Connecteur SATA x4 Connecteur du panneau avant x1 Connecteur Audio du panneau avant x1 Connecteur de sortie S/PDIF x1 Embase de ventilateur UC x1 Embase de ventilateur système x1 Embase d'effacement CMOS x1 Connecteur USB x2 Connecteur d'alimentation x1 (24 broches) Connecteur d'alimentation x1 (4 broches) Connecteur de IR du consommateur x1 Connecteur de Port d'imprimante x1 Connecteur de Port série x1
E/S du panneau arrière	Clavier / Souris PS/2 x1 Port HDMI x1 Port VGA x1 Port DVI-D x1 Port LAN x1 Port USB x4 Fiche audio x3	Clavier / Souris PS/2 x1 Port HDMI x1 Port VGA x1 Port DVI-D x1 Port LAN x1 Port USB x4 Fiche audio x3
Dimensions de la carte	200 mm (l) X 244 mm (H)	200 mm (l) X 244 mm (H)
Fonctionnalités spéciales	Prise en charge RAID 0 / 1 / 1+0	Prise en charge RAID 0 / 1 / 1+0
Support SE	Windows XP / Vista / 7 Biostar se réserve le droit d'ajouter ou de supprimer le support de SE avec ou sans préavis.	Windows XP / Vista / 7 Biostar se réserve le droit d'ajouter ou de supprimer le support de SE avec ou sans préavis.

**ITALIAN**

	<b>A880G+</b>	<b>A785G3+</b>
CPU	Socket AM3 Processori AMD Phenom II/ Athlon II L'architettura AMD 64 abilita la computazione 32 e 64 bit Supporto di Hyper Transport 3.0 e Cool'n'Quiet (Watt massimo: 125W)	Socket AM3 Processori AMD Phenom II/ Athlon II L'architettura AMD 64 abilita la computazione 32 e 64 bit Supporto di Hyper Transport 3.0 e Cool'n'Quiet (Watt massimo: 125W)
FSB	Supporto di HyperTransport 3.0 fino a 5.2 GT/s di larghezza di banda	Supporto di HyperTransport 3.0 fino a 5.2 GT/s di larghezza di banda
Chipset	AMD 880G AMD SB710	AMD 785G AMD SB710
Super I/O	ITE 8721 Fornisce le funzionalità legacy Super I/O usate più comunemente. Interfaccia LPC (Low Pin Count) Funzioni di controllo dell'ambiente: Monitoraggio hardware Funzione "Smart Guardian" di ITE	ITE 8721 Fornisce le funzionalità legacy Super I/O usate più comunemente. Interfaccia LPC (Low Pin Count) Funzioni di controllo dell'ambiente: Monitoraggio hardware Funzione "Smart Guardian" di ITE
Memoria principale	Alloggi DIMM DDR3 x 2 Capacità massima della memoria 8GB Ciascun DIMM supporta DDR3 512MB e 1GB/2GB/4GB Modulo di memoria DDR3 a canale doppio Supporto di DDR3 800 / 1066 / 1333 DIMM registrati e DIMM ECC non sono supportati	Alloggi DIMM DDR3 x 2 Capacità massima della memoria 8GB Ciascun DIMM supporta DDR3 512MB e 1GB/2GB/4GB Modulo di memoria DDR3 a canale doppio Supporto di DDR3 800 / 1066 / 1333 DIMM registrati e DIMM ECC non sono supportati
Grafica	Integrata nel Chipset AMD 880G La memoria video condivisa massima è di 512 MB Supporto DVI/HDMI/HDCP/UVD2	Integrata nel Chipset AMD 785G La memoria video condivisa massima è di 512 MB Supporto DVI/HDMI/HDCP/UVD2
IDE	Controller IDE integrato Modalità Bus Master Ultra DMA 33 / 66 / 100 / 133 Supporto modalità PIO Mode 0-4	Controller IDE integrato Modalità Bus Master Ultra DMA 33 / 66 / 100 / 133 Supporto modalità PIO Mode 0-4
SATA	Controller Serial ATA integrato Velocità di trasferimento dei dati fino a 3 Gb/s. Compatibile specifiche SATA Versione 2.0.	Controller Serial ATA integrato Velocità di trasferimento dei dati fino a 3 Gb/s. Compatibile specifiche SATA Versione 2.0.
LAN	Realtek RTL 8111DL Negoziazione automatica 10 / 100 / 1000 Mb/s Capacità Half / Full Duplex	Realtek RTL 8111DL Negoziazione automatica 10 / 100 / 1000 Mb/s Capacità Half / Full Duplex

**A880G+/A785G3+**

	<b>A880G+</b>	<b>A785G3+</b>
Supporto audio HD	ALC662 Uscita audio 5.1 canali Supporto audio High-Definition (HD)	ALC662 Uscita audio 5.1 canali Supporto audio High-Definition (HD)
Alloggi	Alloggio PCI Express Gen2 x16 x1 Alloggio PCI x2	Alloggio PCI Express Gen2 x16 x1 Alloggio PCI x2
Connettori su scheda	Connettore floppy x1 Connettore IDE x1 Connettore SATA x4 Connettore pannello frontale x1 Connettore audio frontale x1 Connettore output SPDIF x1 Collettore ventolina CPU x1 Collettore ventolina sistema x1 Collettore cancellazione CMOS x1 Connettore USB x2 Connettore alimentazione (24 pin) x1 Connettore alimentazione (4 pin) x1 Connettore IR del consumatore x1 Connettore Porta stampante x1 Connettore Porta seriale x1	Connettore floppy x1 Connettore IDE x1 Connettore SATA x4 Connettore pannello frontale x1 Connettore audio frontale x1 Connettore output SPDIF x1 Collettore ventolina CPU x1 Collettore ventolina sistema x1 Collettore cancellazione CMOS x1 Connettore USB x2 Connettore alimentazione (24 pin) x1 Connettore alimentazione (4 pin) x1 Connettore IR del consumatore x1 Connettore Porta stampante x1 Connettore Porta seriale x1
I/O pannello posteriore	Tastiera / Mouse PS/2 x1 Porta HDMI x1 Porta VGA x1 Porta DVI-D x1 Porta LAN x1 Porta USB x4 Connettore audio x3	Tastiera / Mouse PS/2 x1 Porta HDMI x1 Porta VGA x1 Porta DVI-D x1 Porta LAN x1 Porta USB x4 Connettore audio x3
Dimensioni scheda	200 mm (larghezza) x 244 mm (altezza)	200 mm (larghezza) x 244 mm (altezza)
Caratteristiche speciali	Supporto RAID 0 / 1 / 1+0	Supporto RAID 0 / 1 / 1+0
Sistemi operativi supportati	Windows XP / Vista / 7 Biostar si riserva il diritto di aggiungere o rimuovere il supporto di qualsiasi sistema operativo senza preavviso.	Windows XP / Vista / 7 Biostar si riserva il diritto di aggiungere o rimuovere il supporto di qualsiasi sistema operativo senza preavviso.

**SPANISH**

	<b>A880G+</b>	<b>A785G3+</b>
CPU	<p>Conector AM3</p> <p>Procesadores AMD Phenom II/ Athlon II</p> <p>La arquitectura AMD 64 permite el procesado de 32 y 64 bits</p> <p>Soporta las tecnologías Hyper Transport 3.0 y Cool'n'Quiet</p> <p>(Vatio máximo: 125W)</p>	<p>Conector AM3</p> <p>Procesadores AMD Phenom II/ Athlon II</p> <p>La arquitectura AMD 64 permite el procesado de 32 y 64 bits</p> <p>Soporta las tecnologías Hyper Transport 3.0 y Cool'n'Quiet</p> <p>(Vatio máximo: 125W)</p>
FSB	Admite HyperTransport 3.0 con un ancho de banda de hasta 5.2 GT/s	Admite HyperTransport 3.0 con un ancho de banda de hasta 5.2 GT/s
Conjunto de chips	<p>AMD 880G</p> <p>AMD SB710</p>	<p>AMD 785G</p> <p>AMD SB710</p>
Súper E/S	<p>ITE 8721</p> <p>Le ofrece las funcionalidades heredadas de uso más común Súper E/S.</p> <p>Interfaz de cuenta Low Pin</p> <p>Iniciativas de control de entorno, Monitor hardware</p> <p>Función "Guardia inteligente" de ITE</p>	<p>ITE 8721</p> <p>Le ofrece las funcionalidades heredadas de uso más común Súper E/S.</p> <p>Interfaz de cuenta Low Pin</p> <p>Iniciativas de control de entorno, Monitor hardware</p> <p>Función "Guardia inteligente" de ITE</p>
Memoria principal	<p>Ranuras DIMM DDR3 x 2</p> <p>Capacidad máxima de memoria de 8GB</p> <p>Cada DIMM admite DDR de 512MB y 1GB/2GB/4GB</p> <p>Módulo de memoria DDR3 de canal Doble</p> <p>Admite DDR3 de 800 / 1066 / 1333</p> <p>No admite DIMM registrados o DIMM compatibles con ECC</p>	<p>Ranuras DIMM DDR3 x 2</p> <p>Capacidad máxima de memoria de 8GB</p> <p>Cada DIMM admite DDR de 512MB y 1GB/2GB/4GB</p> <p>Módulo de memoria DDR3 de canal Doble</p> <p>Admite DDR3 de 800 / 1066 / 1333</p> <p>No admite DIMM registrados o DIMM compatibles con ECC</p>
Gráficos	<p>Integrados en el conjunto de chips AMD 880G</p> <p>Memoria máxima de vídeo compartida de 512 MB</p> <p>Admite DVI/HDMI/HDCP/UVD2</p>	<p>Integrados en el conjunto de chips AMD 785G</p> <p>Memoria máxima de vídeo compartida de 512 MB</p> <p>Admite DVI/HDMI/HDCP/UVD2</p>
IDE	<p>Controlador IDE integrado</p> <p>Modo bus maestro Ultra DMA 33 / 66 / 100 / 133</p> <p>Soporte los Modos PIO 0~4,</p>	<p>Controlador IDE integrado</p> <p>Modo bus maestro Ultra DMA 33 / 66 / 100 / 133</p> <p>Soporte los Modos PIO 0~4,</p>
SATA	<p>Controlador ATA Serie Integrado</p> <p>Tasas de transferencia de hasta 3 Gb/s.</p> <p>Compatible con la versión SATA 2.0.</p>	<p>Controlador ATA Serie Integrado</p> <p>Tasas de transferencia de hasta 3 Gb/s.</p> <p>Compatible con la versión SATA 2.0.</p>
Red Local	<p>Realtek RTL 8111DL</p> <p>Negociación de 10 / 100 / 1000 Mb/s</p> <p>Funciones Half / Full dúplex</p>	<p>Realtek RTL 8111DL</p> <p>Negociación de 10 / 100 / 1000 Mb/s</p> <p>Funciones Half / Full dúplex</p>

**A880G+/A785G3+**

	<b>A880G+</b>		<b>A785G3+</b>	
Soporte de sonido HD	ALC662 Salida de sonido de 5.1 canales Soporte de sonido Alta Definición		ALC662 Salida de sonido de 5.1 canales Soporte de sonido Alta Definición	
Ranuras	Ranura PCI Express Gen2 x16	X1	Ranura PCI Express Gen2 x16	X1
	Ranura PCI	X2	Ranura PCI	X2
Conectores en placa	Conector disco flexible	X1	Conector disco flexible	X1
	Conector IDE	X1	Conector IDE	X1
	Conector SATA	X4	Conector SATA	X4
	Conector de panel frontal	X1	Conector de panel frontal	X1
	Conector de sonido frontal	X1	Conector de sonido frontal	X1
	Conector de salida S/PDIF	X1	Conector de salida S/PDIF	X1
	Cabecera de ventilador de CPU	X1	Cabecera de ventilador de CPU	X1
	Cabecera de ventilador de sistema	X1	Cabecera de ventilador de sistema	X1
	Cabecera de borrado de CMOS	X1	Cabecera de borrado de CMOS	X1
	Conector USB	X2	Conector USB	X2
	Conector de alimentación	X1	Conector de alimentación	X1
	(24 patillas)		(24 patillas)	
	Conector de alimentación	X1	Conector de alimentación	X1
(4 patillas)		(4 patillas)		
Conector de IR del consumidor	X1	Conector de IR del consumidor	X1	
Conector Puerto de impresora	X1	Conector Puerto de impresora	X1	
Conector Puerto serie	X1	Conector Puerto serie	X1	
Panel trasero de E/S	Teclado / Ratón PS/2	X1	Teclado / Ratón PS/2	X1
	Ratón HDMI	X1	Ratón HDMI	X1
	Puerto VGA	X1	Puerto VGA	X1
	Puerto DVI-D	X1	Puerto DVI-D	X1
	Puerto de red local	X1	Puerto de red local	X1
	Puerto USB	X4	Puerto USB	X4
	Conector de sonido	X3	Conector de sonido	X3
Tamaño de la placa	200 mm. (A) X 244 Mm. (H)		200 mm. (A) X 244 Mm. (H)	
Funciones especiales	Admite RAID 0 / 1 / 1+0		Admite RAID 0 / 1 / 1+0	
Soporte de sistema operativo	Windows XP / Vista / 7 BioStar se reserva el derecho de añadir o retirar el soporte de cualquier SO con o sin aviso previo.		Windows XP / Vista / 7 BioStar se reserva el derecho de añadir o retirar el soporte de cualquier SO con o sin aviso previo.	

**PORTUGUESE**

	<b>A880G+</b>	<b>A785G3+</b>
CPU	Socket AM3 Processadores AMD Phenom II/ Athlon II A arquitectura AMD 64 permite uma computação de 32 e 64 bits Suporta as tecnologias Hyper Transport 3.0 e Cool'n'Quiet (Watt máximo: 125W)	Socket AM3 Processadores AMD Phenom II/ Athlon II A arquitectura AMD 64 permite uma computação de 32 e 64 bits Suporta as tecnologias Hyper Transport 3.0 e Cool'n'Quiet (Watt máximo: 125W)
FSB	Suporta a tecnologia HyperTransport 3.0 com uma largura de banda até 5.2 GT/s	Suporta a tecnologia HyperTransport 3.0 com uma largura de banda até 5.2 GT/s
Chipset	AMD 880G AMD SB710	AMD 785G AMD SB710
Especificação Super I/O	ITE 8721 Proporciona as funcionalidades mais utilizadas em termos da especificação Super I/O. Interface LPC (Low Pin Count). Iniciativas para controlo do ambiente Monitorização do hardware Função "Smart Guardian" da ITE	ITE 8721 Proporciona as funcionalidades mais utilizadas em termos da especificação Super I/O. Interface LPC (Low Pin Count). Iniciativas para controlo do ambiente Monitorização do hardware Função "Smart Guardian" da ITE
Memória principal	Ranuras DIMM DDR3 x 2 Capacidade máxima de memória: 8 GB Cada módulo DIMM suporta uma memória DDR3 de 512 MB & 1 GB/2 GB/4 GB Módulo de memória DDR3 de canal duplo Suporta módulos DDR3 800 / 1066 / 1333 Os módulos DIMM registados e os DIMM ECC não são suportados	Ranuras DIMM DDR3 x 2 Capacidade máxima de memória: 8 GB Cada módulo DIMM suporta uma memória DDR3 de 512 MB & 1 GB/2 GB/4 GB Módulo de memória DDR3 de canal duplo Suporta módulos DDR3 800 / 1066 / 1333 Os módulos DIMM registados e os DIMM ECC não são suportados
Placa gráfica	Integrada no chipset AMD 880G Memória de vídeo máxima partilhada: 512 MB Suporta as funções DVI/HDMI/HDCP/UV2	Integrada no chipset AMD 785G Memória de vídeo máxima partilhada: 512 MB Suporta as funções DVI/HDMI/HDCP/UV2
IDE	Controlador IDE integrado Modo Bus master Ultra DMA 33 / 66 / 100 / 133 Suporta o modo PIO 0~4,	Controlador IDE integrado Modo Bus master Ultra DMA 33 / 66 / 100 / 133 Suporta o modo PIO 0~4,
SATA	Controlador Serial ATA integrado Velocidades de transmissão de dados até 3 Gb/s. Compatibilidade com a especificação SATA versão 2.0.	Controlador Serial ATA integrado Velocidades de transmissão de dados até 3 Gb/s. Compatibilidade com a especificação SATA versão 2.0.
LAN	Realtek RTL 8111DL Auto negociação de 10 / 100 / 1000 Mb/s Capacidade semi/full-duplex	Realtek RTL 8111DL Auto negociação de 10 / 100 / 1000 Mb/s Capacidade semi/full-duplex



**A880G+/A785G3+**

	<b>A880G+</b>	<b>A785G3+</b>
Suporte para áudio de alta definição	ALC662 Saída de áudio de 5.1 canais Suporta a especificação High-Definition Audio	ALC662 Saída de áudio de 5.1 canais Suporta a especificação High-Definition Audio
Ranhuras	Ranhura PCI Express Gen2 x16 x1 Ranhura PCI x2	Ranhura PCI Express Gen2 x16 x1 Ranhura PCI x2
Conectores na placa	Conector da unidade de disquetes x1 Conector IDE x1 Conector SATA x4 Conector do painel frontal x1 Conector de áudio frontal x1 Conector de saída S/PDIF x1 Conector da ventoinha da CPU x1 Conector da ventoinha do sistema x1 Conector para limpeza do CMOS x1 Conector USB x2 Conector de alimentação (24 pinos) x1 Conector de alimentação (4 pinos) x1 Conector de IR do consumidor x1 Conector da para impressora x1 Conector da Porta série x1	Conector da unidade de disquetes x1 Conector IDE x1 Conector SATA x4 Conector do painel frontal x1 Conector de áudio frontal x1 Conector de saída S/PDIF x1 Conector da ventoinha da CPU x1 Conector da ventoinha do sistema x1 Conector para limpeza do CMOS x1 Conector USB x2 Conector de alimentação (24 pinos) x1 Conector de alimentação (4 pinos) x1 Conector de IR do consumidor x1 Conector da para impressora x1 Conector da Porta série x1
Entradas/Saídas no painel traseiro	Teclado / Rato PS/2 x1 Porta HDMI x1 Porta VGA x1 Porta DVI-D x1 Porta LAN x1 Porta USB x4 Tomada de áudio x3	Teclado / Rato PS/2 x1 Porta HDMI x1 Porta VGA x1 Porta DVI-D x1 Porta LAN x1 Porta USB x4 Tomada de áudio x3
Tamanho da placa	200 mm (L) X 244 mm (A)	200 mm (L) X 244 mm (A)
Características especiais	Suporta as funções RAID 0 / 1 / 1+0	Suporta as funções RAID 0 / 1 / 1+0
Sistemas operativos suportados	Windows XP / Vista / 7 A Biostar reserva-se o direito de adicionar ou remover suporte para qualquer sistema operativo com ou sem aviso prévio.	Windows XP / Vista / 7 A Biostar reserva-se o direito de adicionar ou remover suporte para qualquer sistema operativo com ou sem aviso prévio.

**POLISH**

	<b>A880G+</b>	<b>A785G3+</b>
Procesor	Socket AM3 AMD Phenom II/ Athlon II Procesory Architektura AMD 64 umożliwia przetwarzanie 32 i 64 bitowe Obsługa Hyper Transport 3.0 oraz Cool'n'Quiet (Maksymalny Watt: 125W)	Socket AM3 AMD Phenom II/ Athlon II Procesory Architektura AMD 64 umożliwia przetwarzanie 32 i 64 bitowe Obsługa Hyper Transport 3.0 oraz Cool'n'Quiet (Maksymalny Watt: 125W)
FSB	Obsługa HyperTransport 3.0 o szerokości pasma do 5.2 GT/s	Obsługa HyperTransport 3.0 o szerokości pasma do 5.2 GT/s
Chipset	AMD 880G AMD SB710	AMD 785G AMD SB710
Pamięć główna	Gniazda DDR3 DIMM x 2 Maks. wielkość pamięci 8GB Każde gniazdo DIMM obsługuje moduły 512MB oraz 1GB/2GB/4GB DDR3 Moduł pamięci DDR3 z trybem podwójnego kanału Obsługa DDR3 800 / 1066 / 1333 Brak obsługi Registered DIMM oraz ECC DIMM	Gniazda DDR3 DIMM x 2 Maks. wielkość pamięci 8GB Każde gniazdo DIMM obsługuje moduły 512MB oraz 1GB/2GB/4GB DDR3 Moduł pamięci DDR3 z trybem podwójnego kanału Obsługa DDR3 800 / 1066 / 1333 Brak obsługi Registered DIMM oraz ECC DIMM
Super I/O	ITE 8721 Zapewnia najbardziej powszechne funkcje Super I/O. Interfejs Low Pin Count Funkcje kontroli warunków pracy, Monitor H/W Funkcja ITE "Smart Guardian"	ITE 8721 Zapewnia najbardziej powszechne funkcje Super I/O. Interfejs Low Pin Count Funkcje kontroli warunków pracy, Monitor H/W Funkcja ITE "Smart Guardian"
Grafika	Zintegrowana w chipsecie AMD 880G Maks. wielkość współdzielonej pamięci video wynosi 512 MB Obsługa DVI/HDMI/HDCP/UVD2	Zintegrowana w chipsecie AMD 785G Maks. wielkość współdzielonej pamięci video wynosi 512 MB Obsługa DVI/HDMI/HDCP/UVD2
IDE	Zintegrowany kontroler IDE Ultra DMA 33 / 66 / 100 / 133 Tryb Bus Master obsługa PIO tryb 0~4,	Zintegrowany kontroler IDE Ultra DMA 33 / 66 / 100 / 133 Tryb Bus Master obsługa PIO tryb 0~4,
SATA	Zintegrowany kontroler Serial ATA Transfer danych do 3 Gb/s. Zgodność ze specyfikacją SATA w wersji 2.0.	Zintegrowany kontroler Serial ATA Transfer danych do 3 Gb/s. Zgodność ze specyfikacją SATA w wersji 2.0.
LAN	Realtek RTL 8111DL 110 / 100 / 1000 Mb/s z automatyczną negocjacją szybkości Działanie w trybie połowicznego / pełnego duplexu	Realtek RTL 8111DL 110 / 100 / 1000 Mb/s z automatyczną negocjacją szybkości Działanie w trybie połowicznego / pełnego duplexu

**A880G+/A785G3+**

	<b>A880G+</b>	<b>A785G3+</b>
Obsługa audio HD	ALC662 5.1 kanałowe wyjście audio Obsługa High-Definition Audio	ALC662 5.1 kanałowe wyjście audio Obsługa High-Definition Audio
Gniazda	Gniazdo PCI Express Gen2 x16 x1 Gniazdo PCI x2	Gniazdo PCI Express Gen2 x16 x1 Gniazdo PCI x2
Złącza wbudowane	Złącze napędu dyskietek x1 Złącze IDE x1 Złącze SATA x4 Złącze panela przedniego x1 Przednie złącze audio x1 Złącze wyjścia S/PDIF x1 Złącze głośnikowe wentylatora procesora x1 Złącze głośnikowe wentylatora systemowego x1 Złącze głośnikowe kasowania CMOS x1 Złącze USB x2 Złącze zasilania (24 pinowe) x1 Złącze zasilania (4 pinowe) x1 Złącze Konsument IR x1 Złącze Port drukarki x1 Złącze Port szeregowy x1	Złącze napędu dyskietek x1 Złącze IDE x1 Złącze SATA x4 Złącze panela przedniego x1 Przednie złącze audio x1 Złącze wyjścia S/PDIF x1 Złącze głośnikowe wentylatora procesora x1 Złącze głośnikowe wentylatora systemowego x1 Złącze głośnikowe kasowania CMOS x1 Złącze USB x2 Złącze zasilania (24 pinowe) x1 Złącze zasilania (4 pinowe) x1 Złącze Konsument IR x1 Złącze Port drukarki x1 Złącze Port szeregowy x1
Back Panel I/O	Klawiatura / Mysz PS/2 x1 Port HDMI x1 Port VGA x1 Port DVI-D x1 Port LAN x1 Port USB x4 Gniazdo audio x3	Klawiatura / Mysz PS/2 x1 Port HDMI x1 Port VGA x1 Port DVI-D x1 Port LAN x1 Port USB x4 Gniazdo audio x3
Wymiary płyty	200 mm (S) X 244 mm (W)	200 mm (S) X 244 mm (W)
Funkcje specjalne	Obsługa RAID 0 / 1 / 1+0	Obsługa RAID 0 / 1 / 1+0
Obsługa systemu operacyjnego	Windows XP / Vista / 7 Biostar zastrzega sobie prawo dodawania lub odwoływania obsługi dowolnego systemu operacyjnego bez powiadomienia.	Windows XP / Vista / 7 Biostar zastrzega sobie prawo dodawania lub odwoływania obsługi dowolnego systemu operacyjnego bez powiadomienia.

## RUSSIAN

	<b>A880G+</b>	<b>A785G3+</b>
CPU (центральный процессор)	Гнездо AM3 Процессоры AMD Phenom II/ Athlon II Архитектура AMD 64 разрешать обработка данных на 32 и 64 бит Поддержка Hyper Transport 3.0 и Cool'n'Quiet (Максимальный ватт: 125W)	Гнездо AM3 Процессоры AMD Phenom II/ Athlon II Архитектура AMD 64 разрешать обработка данных на 32 и 64 бит Поддержка Hyper Transport 3.0 и Cool'n'Quiet (Максимальный ватт: 125W)
FSB	Поддержка HyperTransport 3.0 с пропускной способностью до 5.2 GT/s	Поддержка HyperTransport 3.0 с пропускной способностью до 5.2 GT/s
Набор микросхем	AMD 880G AMD SB710	AMD 785G AMD SB710
Основная память	Слоты DDR3 DIMM x 2 Максимальная ёмкость памяти 8 ГБ Каждый модуль DIMM поддерживает 512МБ & 1ГБ/2ГБ/4ГБ DDR3 Модуль памяти с двухканальным режимом DDR3 Поддержка DDR3 800 / 1066 / 1333 Не поддерживает зарегистрированные модули DIMM and ECC DIMM	Слоты DDR3 DIMM x 2 Максимальная ёмкость памяти 8 ГБ Каждый модуль DIMM поддерживает 512МБ & 1ГБ/2ГБ/4ГБ DDR3 Модуль памяти с двухканальным режимом DDR3 Поддержка DDR3 800 / 1066 / 1333 Не поддерживает зарегистрированные модули DIMM and ECC DIMM
Super I/O	ITE 8721 Обеспечивает наиболее используемые действующие функциональные возможности Super I/O. Интерфейс с низким количеством выводов Инициативы по охране окружающей среды, Аппаратный монитор Функция ITE "Smart Guardian" (Интеллектуальная защита)	ITE 8721 Обеспечивает наиболее используемые действующие функциональные возможности Super I/O. Интерфейс с низким количеством выводов Инициативы по охране окружающей среды, Аппаратный монитор Функция ITE "Smart Guardian" (Интеллектуальная защита)
Графика	Встроенная в набор микросхем AMD 880G Максимальная совместно используемая видео память составляет 512 МБ Поддержка DVI/HDMI/HDCP/UVD2	Встроенная в набор микросхем AMD 785G Максимальная совместно используемая видео память составляет 512 МБ Поддержка DVI/HDMI/HDCP/UVD2
IDE	Встроенное устройство управления встроенными интерфейсами устройств Режим "хозяина" шины Ultra DMA 33 / 66 / 100 / 133 Поддержка режима PIO 0~4,	Встроенное устройство управления встроенными интерфейсами устройств Режим "хозяина" шины Ultra DMA 33 / 66 / 100 / 133 Поддержка режима PIO 0~4,
SATA	Встроенное последовательное устройство управления ATA скорость передачи данных до 3 гигабит/с. Соответствие спецификации SATA версия 2.0.	Встроенное последовательное устройство управления ATA скорость передачи данных до 3 гигабит/с. Соответствие спецификации SATA версия 2.0.
Локальная сеть	Realtek RTL 8111DL Автоматическое согласование 10 / 100 / 1000 Мб/с Частичная / полная дуплексная способность	Realtek RTL 8111DL Автоматическое согласование 10 / 100 / 1000 Мб/с Частичная / полная дуплексная способность

**A880G+/A785G3+**

	<b>A880G+</b>	<b>A785G3+</b>
Звуковая поддержка жесткого диска	ALC662 Звуковая поддержка High-Definition 5.1канальный звуковой выход	ALC662 Звуковая поддержка High-Definition 5.1канальный звуковой выход
Слоты	Слот PCI Express Gen2 x16 x1 Слот PCI x2	Слот PCI Express Gen2 x16 x1 Слот PCI x2
Встроенный разъём	Разъём HГМД x1 Разъём IDE x1 Разъём SATA x4 Разъём на лицевой панели x1 Входной звуковой разъём x1 Разъём вывода для S/PDIF x1 Контактирующее приспособление вентилятора центрального процессора x1 Контактирующее приспособление вентилятора системы x1 Открытое контактирующее приспособление CMOS x1 USB-разъём x2 Разъём питания (24 вывод) x1 Разъём питания (4 вывод) x1 Разъём едока ИКБЙИ x1 Разъём Порт подключения принтера x1 Разъём Последовательный порт x1	Разъём HГМД x1 Разъём IDE x1 Разъём SATA x4 Разъём на лицевой панели x1 Входной звуковой разъём x1 Разъём вывода для S/PDIF x1 Контактирующее приспособление вентилятора центрального процессора x1 Контактирующее приспособление вентилятора системы x1 Открытое контактирующее приспособление CMOS x1 USB-разъём x2 Разъём питания (24 вывод) x1 Разъём питания (4 вывод) x1 Разъём едока ИКБЙИ x1 Разъём Порт подключения принтера x1 Разъём Последовательный порт x1
Задняя панель средств ввода-вывода	Клавиатура / Мышь PS/2 x1 Порт HDMI x1 Порт VGA x1 Порт DVI-D x1 Порт LAN x1 USB-порт x4 Гнездо для подключения наушников x3	Клавиатура / Мышь PS/2 x1 Порт HDMI x1 Порт VGA x1 Порт DVI-D x1 Порт LAN x1 USB-порт x4 Гнездо для подключения наушников x3
Размер панели	200 мм (Ш) X 244 мм (В)	200 мм (Ш) X 244 мм (В)
Специальные технические характеристики	Поддержка RAID 0 / 1 / 1+0	Поддержка RAID 0 / 1 / 1+0
Поддержка OS	Windows XP / Vista / 7 Biostar сохраняет за собой право добавлять или удалять средства обеспечения для OS с или без предварительного уведомления.	Windows XP / Vista / 7 Biostar сохраняет за собой право добавлять или удалять средства обеспечения для OS с или без предварительного уведомления.

## ARABIC

A785G3+	A880G+	
AM3 مقيس AMD Phenom II/ Athlon II إجراء العمليات الحاسوبية بسرعة 32 و 64 بت AMD 64 يمكن تقنية Cool'n'Quiet و Hyper Transport 3.0 تدعم تقنية (125: قصوى واط)	AM3 مقيس AMD Phenom II/ Athlon II إجراء العمليات الحاسوبية بسرعة 32 و 64 بت AMD 64 يمكن تقنية Cool'n'Quiet و Hyper Transport 3.0 تدعم تقنية (125: قصوى واط)	وحدة المعالجة المركزية
5.2 GT/s تردد يصل إلى HyperTransport 3.0 تدعم تقنية	5.2 GT/s تردد يصل إلى HyperTransport 3.0 تدعم تقنية	النقل الأممي الجانبي
AMD 785G AMD SB710	AMD 880G AMD SB710	مجموعة الشرائح
ITE 8721 الأكثر استخداماً، Super I/O ووظيفة Low Pin Count Interface تدعم تقنية وسائل التحكم في البيئة: مراقب لمعرفة حالة الأجهزة من ITE "Smart Guardian" ووظيفة	ITE 8721 الأكثر استخداماً، Super I/O ووظيفة Low Pin Count Interface تدعم تقنية وسائل التحكم في البيئة: مراقب لمعرفة حالة الأجهزة من ITE "Smart Guardian" ووظيفة	Super I/O
عدد 2 قناة DDR3 DIMM سعة ذاكرة قصوى 8 جيجا بايت ميجا بايت 512 سعة DDR3 تدعم ذاكرة من نوع DIMM تدعم كل قناة و1/2 و4 جيجا بايت مزوجة القناة DDR3 وحدة ذاكرة سعت 1333 / 1066 / 800 ميجا بايت DDR3 تدعم الذاكرة من نوع ECC وتلك التي لا تتوافق مع DIMM لا تدعم رقائق الذاكرة	عدد 2 قناة DDR3 DIMM سعة ذاكرة قصوى 8 جيجا بايت ميجا بايت 512 سعة DDR3 تدعم ذاكرة من نوع DIMM تدعم كل قناة و1/2 و4 جيجا بايت مزوجة القناة DDR3 وحدة ذاكرة سعت 1333 / 1066 / 800 ميجا بايت DDR3 تدعم الذاكرة من نوع ECC وتلك التي لا تتوافق مع DIMM لا تدعم رقائق الذاكرة	الذاكرة الرئيسية
AMD 785G مدمجة في رقائق ميجا بايت 512 أقصى سعة لذاكرة الفيديو المشتركة DVI/HDMI/HDCP/UV2 تدعم تقنية	AMD 880G مدمجة في رقائق ميجا بايت 512 أقصى سعة لذاكرة الفيديو المشتركة DVI/HDMI/HDCP/UV2 تدعم تقنية	بطاقة الرسومات
متكامل IDE متحكم وضع رئيسي 133 / 100 / 66 / 33 Ultra DMA نقل تقنية PIO Mode 0 ~ 4 دعم وضع	متكامل IDE متحكم وضع رئيسي 133 / 100 / 66 / 33 Ultra DMA نقل تقنية PIO Mode 0 ~ 4 دعم وضع	منفذ IDE
متكامل Serial ATA متحكم جيجابت/ثانية، 3 نقل البيانات بسرعة تصل إلى 2.0، الإصدار SATA مطابقة لمواصفات	متكامل Serial ATA متحكم جيجابت/ثانية، 3 نقل البيانات بسرعة تصل إلى 2.0، الإصدار SATA مطابقة لمواصفات	SATA
Realtek RTL 8111DL تفاوض تلقائي 100/10 ميجا بايت / ثانية و 1 جيجا بت/ثانية إمكانية النقل المزدوج الكامل/القصفي	Realtek RTL 8111DL تفاوض تلقائي 100/10 ميجا بايت / ثانية و 1 جيجا بت/ثانية إمكانية النقل المزدوج الكامل/القصفي	شبكة داخلية

**A880G+/A785G3+**

<b>A785G3+</b>		<b>A880G+</b>		
ALC662	قوت لخرج الصوت 5.1	ALC662	قوت لخرج الصوت 5.1	دعم الصوت عالي التعريف
	تدعم تقنية الصوت عالي التعريف من		تدعم تقنية الصوت عالي التعريف من	
عدد 1	قحة PCI Express Gen2 x16	عدد 1	قحة PCI Express Gen2 x16	التحات
عدد 2	قحة PCI	عدد 2	قحة PCI	
عدد 1	منفذ محرك أقراص مرنة	عدد 1	منفذ محرك أقراص مرنة	المنفذ على سطح اللوحة
عدد 1	منفذ IDE	عدد 1	منفذ IDE	
عدد 4	منفذ SATA	عدد 4	منفذ SATA	
عدد 1	منفذ اللوحة الأملية	عدد 1	منفذ اللوحة الأملية	
عدد 1	منفذ الصوت الأملي	عدد 1	منفذ الصوت الأملي	
عدد 1	منفذ خرج S/PDIF	عدد 1	منفذ خرج S/PDIF	
عدد 1	وصلة مروحة وحدة المعالجة المركزية	عدد 1	وصلة مروحة وحدة المعالجة المركزية	
عدد 1	وصلة مروحة النظام	عدد 1	وصلة مروحة النظام	
عدد 1	وصلة مسح CMOS	عدد 1	وصلة مسح CMOS	
عدد 2	منفذ USB	عدد 2	منفذ USB	
عدد 1	منفذ توصيل الطاقة (24بيوس)	عدد 1	منفذ توصيل الطاقة (24بيوس)	
عدد 1	منفذ توصيل الطاقة (4بيوس)	عدد 1	منفذ توصيل الطاقة (4بيوس)	
عدد 1	منفذ الأحمر تحت مستهلكة	عدد 1	منفذ الأحمر تحت مستهلكة	
عدد 1	منفذ طباعة	عدد 1	منفذ طباعة	
عدد 1	منفذ تسلسلي	عدد 1	منفذ تسلسلي	
عدد 1	لوحة مفاتيح / ملوس PS/2	عدد 1	لوحة مفاتيح / ملوس PS/2	منفذ دخل/خرج اللوحة الخلفية
عدد 1	منافذ HDMI	عدد 1	منافذ HDMI	
عدد 1	منافذ VGA	عدد 1	منافذ VGA	
عدد 1	منافذ DVI-D	عدد 1	منافذ DVI-D	
عدد 1	منفذ شبكة اتصال محلية	عدد 1	منفذ شبكة اتصال محلية	
عدد 4	منافذ USB	عدد 4	منافذ USB	
عدد 3	مقيس صوت	عدد 3	مقيس صوت	
	200مم (عرض) X 244مم (ارتفاع)		200مم (عرض) X 244مم (ارتفاع)	حجم اللوحة
	RAID 0 / 1 / 1+0		RAID 0 / 1 / 1+0	مزيا خاصة
	Windows XP / Vista / 7		Windows XP / Vista / 7	دعم أنظمة التشغيل
	بحقها في اضافة أو ازالة الدعم لأي نظام تشغيل بإخطار أو <b>Biostar</b> تحتفظ بدون إخطار .		بحقها في اضافة أو ازالة الدعم لأي نظام تشغيل بإخطار أو <b>Biostar</b> تحتفظ بدون إخطار .	

## JAPANESE

	A880G+	A785G3+
CPU	Socket AM3 AMD Phenom II/ Athlon II プロセッサ AMD 64アーキテクチャでは、32ビットと64ビット計算が可能です ハイパートランスポート3.0とクールアンドクワイエットをサポートします (最高のワット: 125W)	Socket AM3 AMD Phenom II/ Athlon II プロセッサ AMD 64アーキテクチャでは、32ビットと64ビット計算が可能です ハイパートランスポート3.0とクールアンドクワイエットをサポートします (最高のワット: 125W)
FSB	5.2 GT/sのバンド幅までハイパートランスポート3.0をサポートします	5.2 GT/sのバンド幅までハイパートランスポート3.0をサポートします
チップセット	AMD 880G AMD SB710	AMD 785G AMD SB710
メインメモリ	DDR3 DIMMスロット x 2 最大メモリ容量8GB 各DIMMは 512MB & 1GB/2GB/4GB DDR3をサポート デュアル チャンネルモードDDR3 メモリモジュール DDR3 800 / 1066 / 1333 をサポート 登録済みDIMMとECC DIMMはサポートされません	DDR3 DIMMスロット x 2 最大メモリ容量8GB 各DIMMは 512MB & 1GB/2GB/4GB DDR3をサポート デュアル チャンネルモードDDR3 メモリモジュール DDR3 800 / 1066 / 1333 をサポート 登録済みDIMMとECC DIMMはサポートされません
Super I/O	ITE 8721 もつとも一般に使用されるレガシーSuper I/O機能を採用しています。 低ピンカウントインターフェイス 環境コントロールイニシアチブ、 H/Wモニター ITEの「スマートガーディアン」機能	ITE 8721 もつとも一般に使用されるレガシーSuper I/O機能を採用しています。 低ピンカウントインターフェイス 環境コントロールイニシアチブ、 H/Wモニター ITEの「スマートガーディアン」機能
グラフィックス	AMD 880Gチップセットに統合 最大の共有ビデオメモリは512MBです DVI/HDMI/HDPCP/UVDP2 のサポート	AMD 785Gチップセットに統合 最大の共有ビデオメモリは512MBです DVI/HDMI/HDPCP/UVDP2 のサポート
IDE	統合IDEコントローラ Ultra DMA 33 / 66 / 100 / 133バスマスタモード PIO Mode 0~4のサポート、	統合IDEコントローラ Ultra DMA 33 / 66 / 100 / 133バスマスタモード PIO Mode 0~4のサポート、
SATA	統合シリアルATA コントローラ 最高3Gb/秒のデータ転送速度 SATAバージョン2.0仕様に準拠。	統合シリアルATA コントローラ 最高3Gb/秒のデータ転送速度 SATAバージョン2.0仕様に準拠。
LAN	Realtek RTL 8111DL 10 / 100 / 1000 Mb/秒のオートネゴシエーション 半/全二重機能	Realtek RTL 8111DL 10 / 100 / 1000 Mb/秒のオートネゴシエーション 半/全二重機能



**A880G+/A785G3+**

	<b>A880G+</b>		<b>A785G3+</b>	
HDオーディオのサポート	ALC662 5.1チャンネルオーディオアウト ハイデフィニションオーディオのサポート		ALC662 5.1チャンネルオーディオアウト ハイデフィニションオーディオのサポート	
スロット	PCI Express Gen2 x16スロット	x1	PCI Express Gen2 x16スロット	x1
	PCIスロット	x2	PCIスロット	x2
オンボードコネクタ	フロッピーコネクタ	x1	フロッピーコネクタ	x1
	IDEコネクタ	x1	IDEコネクタ	x1
	SATAコネクタ	x4	SATAコネクタ	x4
	フロントパネルコネクタ	x1	フロントパネルコネクタ	x1
	フロントオーディオコネクタ	x1	フロントオーディオコネクタ	x1
	S/PDIFアウトコネクタ	x1	S/PDIFアウトコネクタ	x1
	CPUファンヘッダ	x1	CPUファンヘッダ	x1
	システムファンヘッダ	x1	システムファンヘッダ	x1
	CMOSクリアヘッダ	x1	CMOSクリアヘッダ	x1
	USBコネクタ	x2	USBコネクタ	x2
	電源コネクタ(24ピン)	x1	電源コネクタ(24ピン)	x1
	電源コネクタ(4ピン)	x1	電源コネクタ(4ピン)	x1
	消費者IRコネクタ	x1	消費者IRコネクタ	x1
	プリンタポートコネクタ	x1	プリンタポートコネクタ	x1
	シリアルポートコネクタ	x1	シリアルポートコネクタ	x1
背面パネルI/O	PS/2キーボード / マウス	x1	PS/2キーボード / マウス	x1
	HDMIポート	x1	HDMIポート	x1
	VGAポート	x1	VGAポート	x1
	DVI-Dポート	x1	DVI-Dポート	x1
	LANポート	x1	LANポート	x1
	USBポート	x4	USBポート	x4
	オーディオジャック	x3	オーディオジャック	x3
ボードサイズ	200 mm (幅) X 244 mm (高さ)		200 mm (幅) X 244 mm (高さ)	
特殊機能	RAID 0 / 1 / 1+0 のサポート		RAID 0 / 1 / 1+0 のサポート	
OSサポート	Windows XP / Vista / 7 Biostarは事前のサポートなしにOSサポートを追加または削除する権利を留保します。		Windows XP / Vista / 7 Biostarは事前のサポートなしにOSサポートを追加または削除する権利を留保します。	

2010/05/19