

## FCC Information and Copyright

This equipment has been tested and found to comply with the limits of a Class B digital device, pursuant to Part 15 of the FCC Rules. These limits are designed to provide reasonable protection against harmful interference in a residential installation. This equipment generates, uses, and can radiate radio frequency energy and, if not installed and used in accordance with the instructions, may cause harmful interference to radio communications. There is no guarantee that interference will not occur in a particular installation.

The vendor makes no representations or warranties with respect to the contents here and specially disclaims any implied warranties of merchantability or fitness for any purpose. Further the vendor reserves the right to revise this publication and to make changes to the contents here without obligation to notify any party beforehand.

Duplication of this publication, in part or in whole, is not allowed without first obtaining the vendor's approval in writing.

The content of this user's manual is subject to be changed without notice and we will not be responsible for any mistakes found in this user's manual. All the brand and product names are trademarks of their respective companies.



**Dichiarazione di conformità sintetica**

Ai sensi dell'art. 2 comma 3 del D.M. 275 del 30/10/2002

Si dichiara che questo prodotto è conforme alle normative vigenti e soddisfa i requisiti essenziali richiesti dalle direttive

2004/108/CE, 2006/95/CE e 1999/05/CE

quando ad esso applicabili

**Short Declaration of conformity**

We declare this product is complying with the laws in force and meeting all the essential requirements as specified by the directives

2004/108/CE, 2006/95/CE and 1999/05/CE

whenever these laws may be applied

---

---

## Table of Contents

---

---

<b>Chapter 1: Introduction</b> .....	<b>1</b>
<b>1.1 Before You Start</b> .....	1
<b>1.2 Package Checklist</b> .....	1
<b>1.3 Motherboard Features</b> .....	2
<b>1.4 Rear Panel Connectors</b> .....	4
<b>1.5 Motherboard Layout</b> .....	5
<b>Chapter 2: Hardware Installation</b> .....	<b>6</b>
<b>2.1 Installing Central Processing Unit (CPU)</b> .....	6
<b>2.2 FAN Headers</b> .....	8
<b>2.3 Installing System Memory</b> .....	9
<b>2.4 Connectors and Slots</b> .....	11
<b>Chapter 3: Headers &amp; Jumpers Setup</b> .....	<b>14</b>
<b>3.1 How to Setup Jumpers</b> .....	14
<b>3.2 Detail Settings</b> .....	14
<b>Chapter 4: RAID Functions</b> .....	<b>19</b>
<b>4.1 Operating System</b> .....	19
<b>4.2 Raid Arrays</b> .....	19
<b>4.3 How RAID Works</b> .....	19
<b>Chapter 5: Useful Help</b> .....	<b>23</b>
<b>5.1 Driver Installation Note</b> .....	23
<b>5.2 Software</b> .....	24
<b>5.3 Extra Information</b> .....	28
<b>5.4 AMI BIOS Beep Code</b> .....	29
<b>5.5 Troubleshooting</b> .....	30
<b>Appendix: SPEC In Other Languages</b> .....	<b>31</b>
<b>German</b> .....	32
<b>French</b> .....	34
<b>Italian</b> .....	36
<b>Spanish</b> .....	38
<b>Portuguese</b> .....	40
<b>Polish</b> .....	42
<b>Russian</b> .....	44
<b>Arabic</b> .....	46
<b>Japanese</b> .....	48

## **CHAPTER 1: INTRODUCTION**

### **1.1 BEFORE YOU START**

Thank you for choosing our product. Before you start installing the motherboard, please make sure you follow the instructions below:

- Prepare a dry and stable working environment with sufficient lighting.
- Always disconnect the computer from power outlet before operation.
- Before you take the motherboard out from anti-static bag, ground yourself properly by touching any safely grounded appliance, or use grounded wrist strap to remove the static charge.
- Avoid touching the components on motherboard or the rear side of the board unless necessary. Hold the board on the edge, do not try to bend or flex the board.
- Do not leave any unfastened small parts inside the case after installation. Loose parts will cause short circuits which may damage the equipment.
- Keep the computer from dangerous area, such as heat source, humid air and water.
- The operating temperatures of the computer should be 0 to 45 degrees Celsius.

### **1.2 PACKAGE CHECKLIST**

- ✚ Serial ATA Cable X 2
- ✚ Rear I/O Panel for ATX Case X 1
- ✚ User's Manual X 1
- ✚ Fully Setup Driver DVD X 1

**Note:** The package contents may be different due to area or your motherboard version.

### 1.3 MOTHERBOARD FEATURES

SPEC		
CPU	Socket 1155 Intel Core i7 / i5 / i3 / Pentium / Celeron processor	Supports Execute Disable Bit / Enhanced Intel SpeedStep® / Intel Architecture-64 / Extended Memory 64 Technology / Virtualization Technology / Hyper Threading
Chipset	Intel H77	
Super I/O	IT8728 Provides the most commonly used legacy Super I/O functionality. Low Pin Count Interface	Environment Control initiatives, Hardware Monitor Controller Fan Speed Controller ITE's "Smart Guardian" function
Main Memory	DDR3 DIMM Slots x 4 Max Memory Capacity 32GB Each DIMM supports 512MB/ 1GB/2GB/4GB/8GB DDR3	Dual Channel Mode DDR3 memory module Supports DDR3 1066 / 1333 Supports DDR3 1600 (depending on CPU) Registered DIMM and ECC DIMM is not supported
SATA 2 & 3	Integrated Serial ATA Controller	Data transfer rates up to 3.0 Gb/s / 6.0 Gb/s. SATA Version 2.0 / 3.0 specification compliant RAID 0,1,5,10, SRT support
LAN	Realtek RTL 8111E	10 / 100 Mb/s / 1Gb/s auto negotiation Half / Full duplex capability
Sound Codec	ALC662	5.1 channels audio out High Definition Audio
USB3.0	H77	Data transfer rates up to 600 MB/s
Slots	PCI Express Gen3 x 16 slot (Depending on CPU) x1 PCI Express Gen2 x 16 slot(x4) x1 PCI Express Gen2 x 1 slot x2	Supports PCI-E Gen3 x16 expansion card Supports PCI-E Gen2 x16 expansion card Supports PCI-E Gen2 x1 expansion cards

## H77MU3

On Board Connectors	SATA3 Connector	x2	Each connector supports 1 SATA3 devices
	SATA2 Connector	x4	Each connector supports 1 SATA2 devices
	Front Panel Connector	x1	Supports front panel facilities
	Front Audio Connector	x1	Supports front panel audio function
	CPU Fan Header	x1	CPU Fan power supply (with Smart Fan function)
	System Fan Header	x1	System Fan Power supply
	Clear CMOS Header	x1	Restore CMOS data to factory default
	USB2.0 Connector	x2	Each connector supports 2 front panel USB2.0 ports
	USB3.0 Connector	x1	Each connector supports 2 front panel USB3.0 ports
	Consumer IR Connector	x1	Supports infrared function
	Printer Port Connector	x1	Each connector supports 1 Printer port
	Serial Port Connector	x1	Connects to RS-232 Port
	Power Connector (24pin)	x1	Connects to Power supply
	Power Connector (4pin)	x1	Connects to Power supply
Back Panel I/O	PS/2 Keyboard	x1	Connects to PS/2 Keyboard
	HDMI Port	x1	Connects to HDMI cable
	VGA Port	x1	Connect to D-SUB monitor
	DVI Port	x1	Connect to DVI monitor
	LAN port	x1	Connect to RJ-45 ethernet cable
	USB2.0 Port	x2	Connect to USB2.0 devices
	USB3.0 Port	x2	Connect to USB3.0 devices
	Audio Jack	x3	Provide Audio-In/Out and Mic. connection
Board Size	220 (W) x 244 (L) mm	ATX	
OS Support	Windows XP / Vista / 7	Biostar reserves the right to add or remove support for any OS with or without notice	

## 1.4 REAR PANEL CONNECTORS

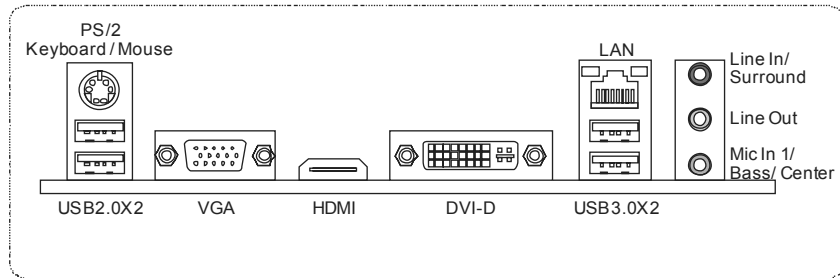

**NOTE:** HDMI, DVI-D & VGA ports only work with an Intel integrated Graphics Processor.

**NOTE:** USB3.0 (only supported by Windows 7) ports are backward compatible with USB2.0/USB1.X devices.

**NOTE:** Maximum resolution:  
 HDMI: 1920 x 1200 @60Hz, compliant with HDMI 1.4a  
 DVI: 1920 x 1200 @60Hz  
 VGA: 2048 x 1536 @75Hz

**NOTE:** This motherboard supports Multiple VGA output:

Display Devices	VGA	DVI-D	HDMI
<b>VGA</b>	X	A	A
<b>DVI-D</b>	A	X	S <sup>1</sup> , C, E
<b>HDMI</b>	A	S <sup>1</sup> , C, E	X

- A = Single Pipe Single Display, Intel® Dual Display Clone (Only 24-bpp), or Extended Desktop Mode
- C = Clone Mode
- E = Extended Desktop Mode
- S<sup>1</sup> = Single Pipe Single Display With One Display Device Disabled
- X = Unsupported / Note Applicable

### 1.5 MOTHERBOARD LAYOUT

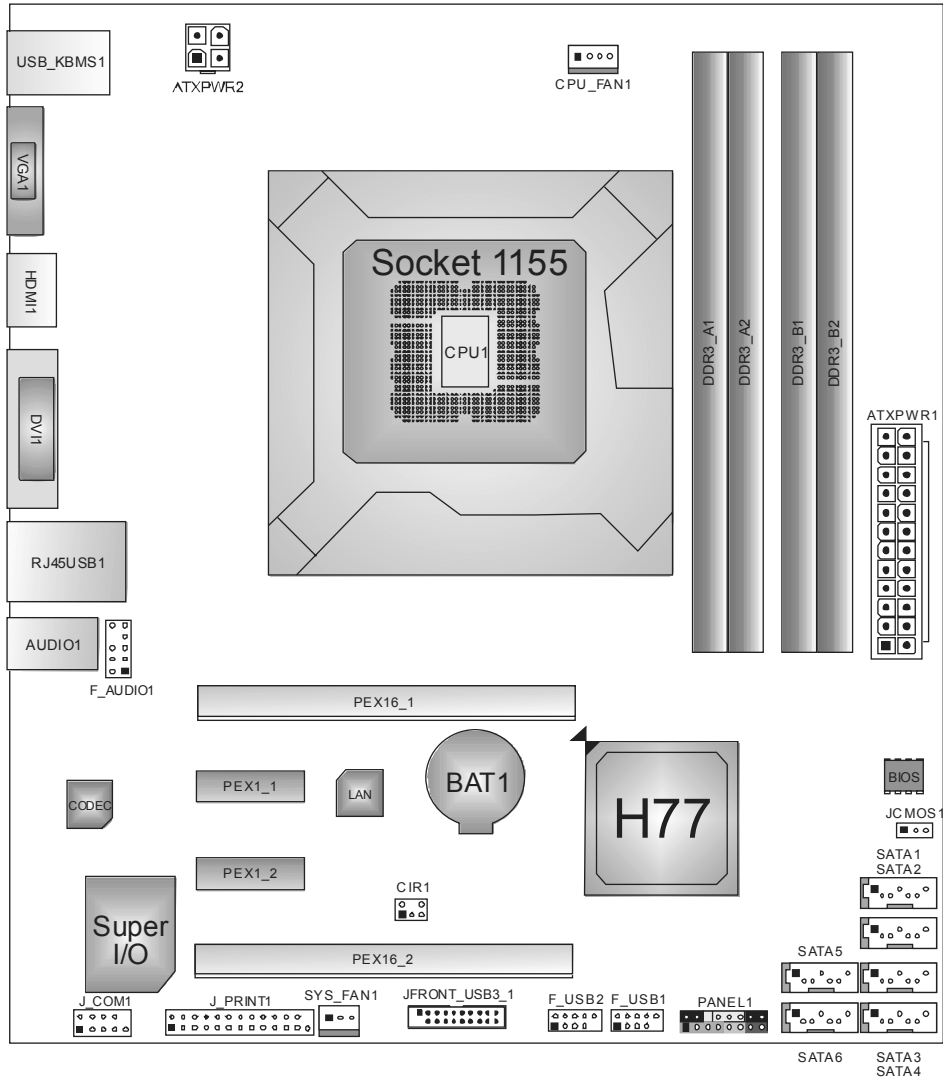

**Note:** ■ represents the 1<sup>st</sup> pin.

## CHAPTER 2: HARDWARE INSTALLATION

### 2.1 INSTALLING CENTRAL PROCESSING UNIT (CPU)

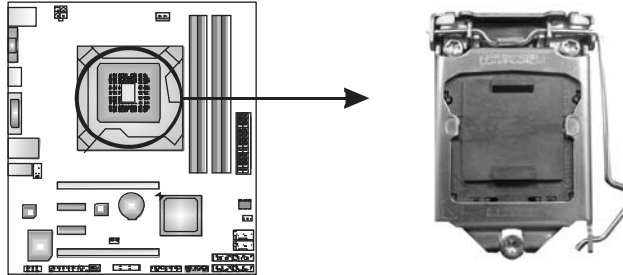

**Notice:**

1. Remove Pin Cap before installation, and make good preservation for future use. When the CPU is removed, cover the Pin Cap on the empty socket to ensure pin legs won't be damaged.
2. The motherboard might equip with two different types of pin cap. Please refer below instruction to remove the pin cap.

**Step 1:** Pull the socket locking lever out from the socket and then raise the lever up.

Type A

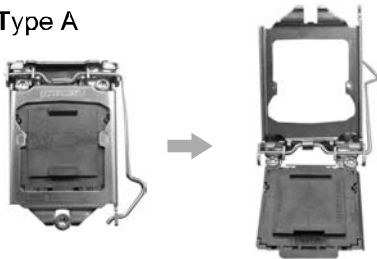

Type B

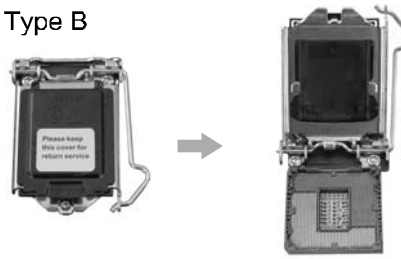

**Step 2:** Remove the Pin Cap.

Type A

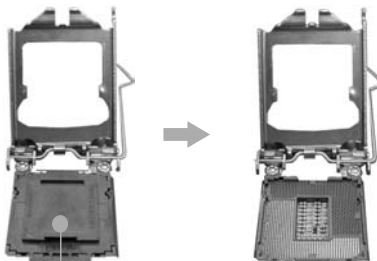

Pin Cap

Type B

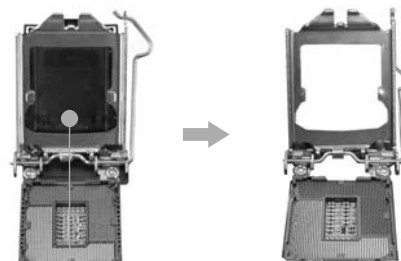

Pin Cap



**Step 3:** Hold processor with your thumb and index fingers, oriented as shown. Align the notches with the socket. Lower the processor straight down without tilting or sliding the processor in the socket.

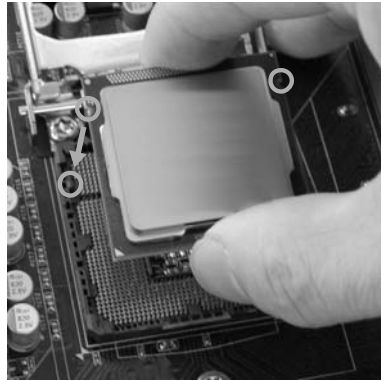

**Step 4:** Hold the CPU down firmly, and then lower the lever to locked position to complete the installation.



**Step 5:** Put the CPU Fan and heatsink assembly on the CPU and buckle it on the retention frame. Connect the CPU FAN power cable into the CPU\_FAN1 to complete the installation.

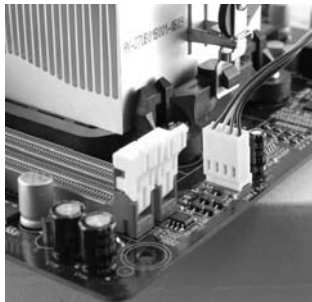

## 2.2 FAN HEADERS

These fan headers support cooling-fans built in the computer. The fan cable and connector may be different according to the fan manufacturer. Connect the fan cable to the connector while matching the black wire to pin#1.

### CPU\_FAN1: CPU Fan Header

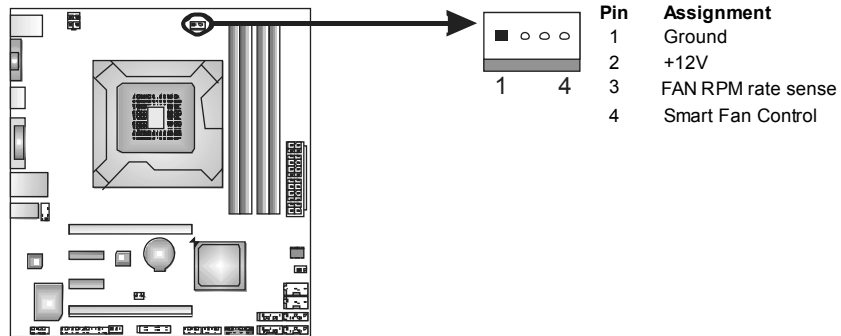

### SYS\_FAN1: System Fan Header

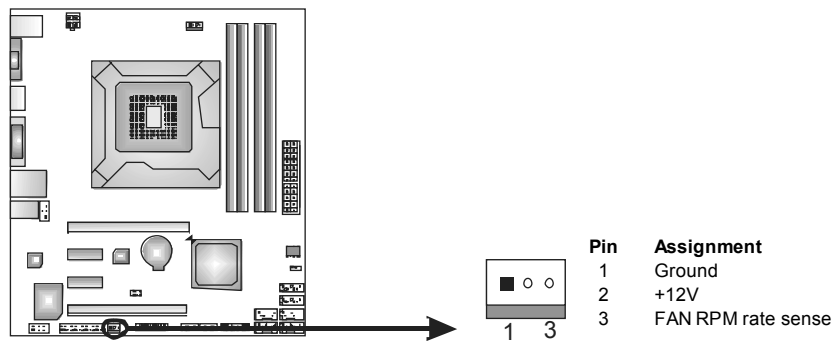

**Note:**

The SYS\_FAN1 supports 3-pin head connector; the CPU\_FAN1 supports 4-pin head connector. When connecting with wires onto connectors, please note that the red wire is the positive and should be connected to pin#2, and the black wire is Ground and should be connected to GND.

## 2.3 INSTALLING SYSTEM MEMORY

### A. Memory Modules

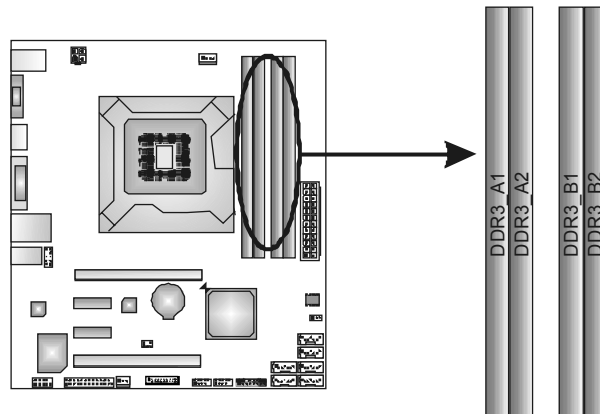

1. Unlock a DIMM slot by pressing the retaining clips outward. Align a DIMM on the slot such that the notch on the DIMM matches the

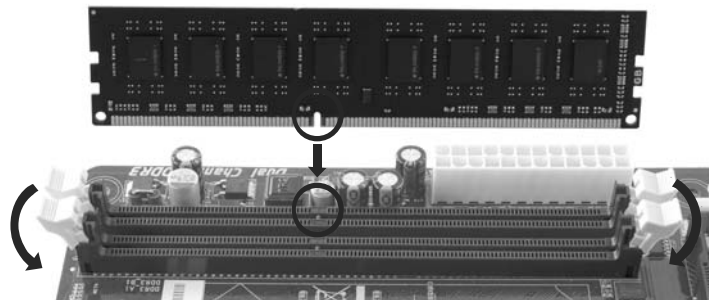

2. Insert the DIMM vertically and firmly into the slot until the retaining chip snap back in place and the DIMM is properly seated.

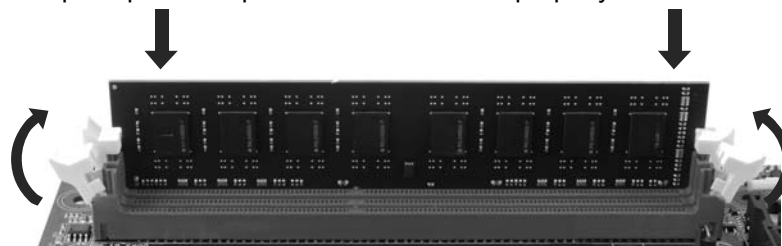

**Note:**

If the DIMM does not go in smoothly, do not force it. Pull it all the way out and try again.

**B. Memory Capacity**

DIMM Socket Location	DDR3 Module	Total Memory Size
DDR3_A1	512MB/1GB/2GB/4GB/8GB	Max is 32GB.
DDR3_A2	512MB/1GB/2GB/4GB/8GB	
DDR3_B1	512MB/1GB/2GB/4GB/8GB	
DDR3_B2	512MB/1GB/2GB/4GB/8GB	

**C. Dual Channel Memory Installation**

Please refer to the following requirements to activate Dual Channel function:

Install memory module of the same density in pairs, shown in the table.

Dual Channel Status	DDR3_A1	DDR3_A2	DDR3_B1	DDR3_B2
Enabled	O	X	O	X
Enabled	X	O	X	O
Enabled	O	O	O	O
Enabled	O	X	X	O
Enabled	X	O	O	X

(O means memory installed, X means memory not installed.)

The DRAM bus width of the memory module must be the same (x8 or x16)

## 2.4 CONNECTORS AND SLOTS

### SATA1/SATA2: Serial ATA3.0 Connectors

The motherboard has a PCI to SATA Controller with 2 channels SATA interface, it satisfies the SATA 3.0 spec and with transfer rate of 6.0Gb/s.

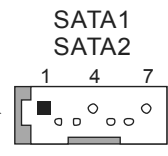
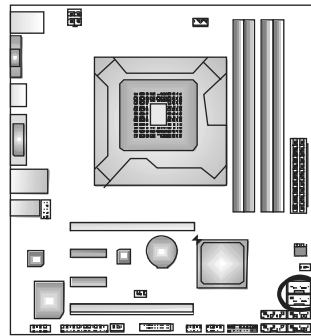

Pin	Assignment
1	Ground
2	TX+
3	TX-
4	Ground
5	RX-
6	RX+
7	Ground

### SATA3 ~ 6: Serial ATA2.0 Connectors

The motherboard has a PCI to SATA Controller with 4 channels SATA2 interface, it satisfies the SATA 2.0 spec and with transfer rate of 3.0Gb/s.

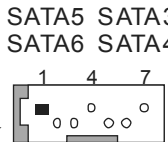
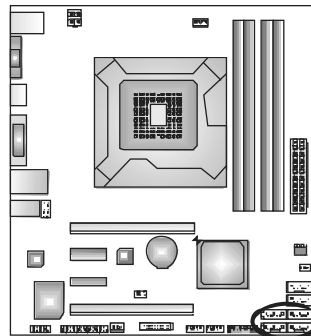

Pin	Assignment
1	Ground
2	TX+
3	TX-
4	Ground
5	RX-
6	RX+
7	Ground

**PEX16\_1: PCI-Express Gen3 x16 Slot**

- PCI-Express 3.0 compliant.
- Maximum theoretical realized bandwidth of 16GB/s simultaneously per direction, for an aggregate of 32GB/s totally.
- PCI-Express Gen3 supports a raw bit-rate of 8.0Gb/s on the data pins.
- PCI-E 3.0 is supported by Core i7-3xxx / i5-3xxx CPU.

**PEX16\_2: PCI-Express Gen2 x4 Slot**

- PCI-Express 2.0 compliant.
- Maximum theoretical realized bandwidth of 2GB/s simultaneously per direction, for an aggregate of 4GB/s totally.

**PEX1\_1/PEX1\_2: PCI-Express Gen2 x1 Slot**

- PCI-Express 2.0 compliant.
- Data transfer bandwidth up to 500MB/s per direction; 1GB/s in total.
- PCI-Express supports a raw bit-rate of 2.5Gb/s on the data pins.
- 2X bandwidth over the traditional PCI architecture.

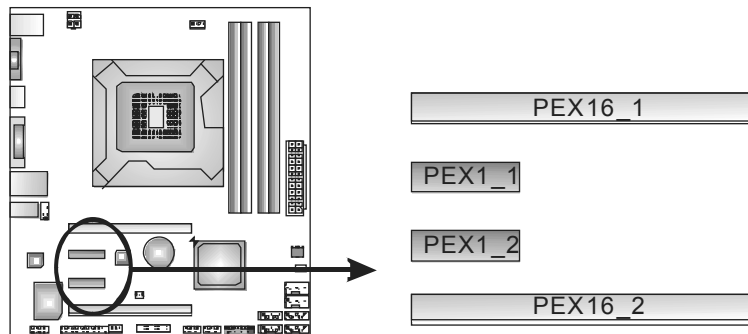

**ATXPWR1: ATX Power Source Connector**

This connector allows user to connect 24-pin power connector on the ATX power supply.

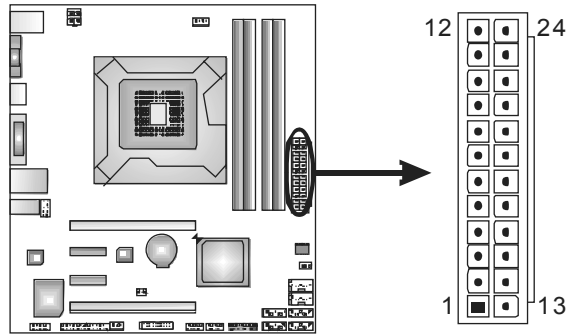

Pin	Assignment	Pin	Assignment
13	+3.3V	1	+3.3V
14	-12V	2	+3.3V
15	Ground	3	Ground
16	PS_ON	4	+5V
17	Ground	5	Ground
18	Ground	6	+5V
19	Ground	7	Ground
20	NC	8	PW_OK
21	+5V	9	Standby Voltage+5V
22	+5V	10	+12V
23	+5V	11	+12V
24	Ground	12	+3.3V

**ATXPWR2: ATX Power Source Connector**

This connector provides +12V to CPU power circuit.

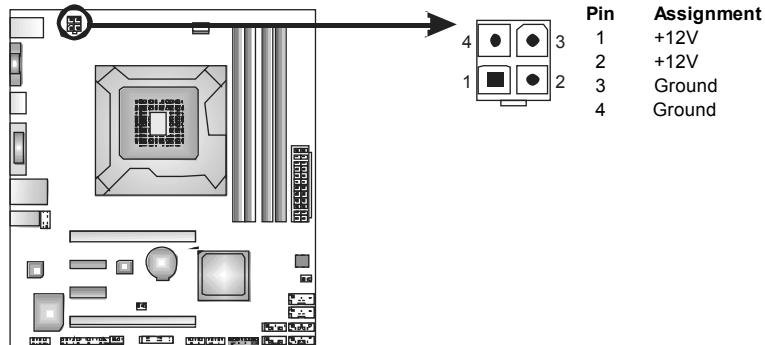

Pin	Assignment
1	+12V
2	+12V
3	Ground
4	Ground

**Note:**

Before you power on the system, please make sure that ATXPWR1 and ATXPWR2 connectors have been well plugged-in.

## CHAPTER 3: HEADERS & JUMPERS SETUP

### 3.1 HOW TO SETUP JUMPERS

The illustration shows how to set up jumpers. When the jumper cap is placed on pins, the jumper is “close”, if not, that means the jumper is “open”.

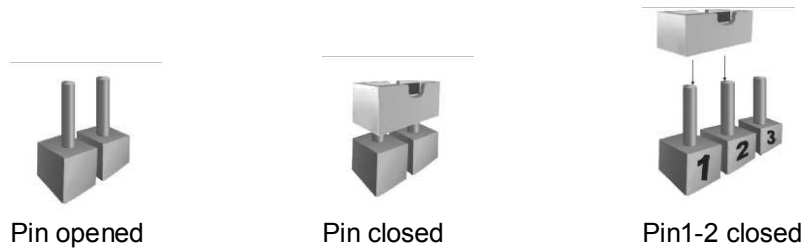

### 3.2 DETAIL SETTINGS

#### PANEL1: Front Panel Header

This 16-pin connector includes Power-on, Reset, HDD LED, Power LED, and speaker connection. It allows user to connect the PC case’s front panel switch functions.

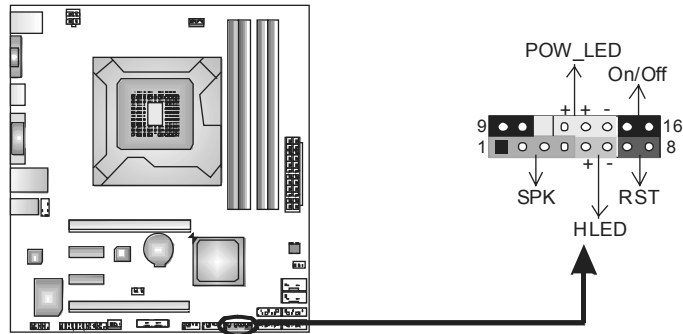

Pin	Assignment	Function	Pin	Assignment	Function
1	+5V	Speaker Connector	9	N/A	Power LED
2	N/A		10	N/A	
3	N/A		11	N/A	
4	Speaker	Hard drive LED	12	Power LED (+)	Power-on button
5	HDD LED (+)		13	Power LED (+)	
6	HDD LED (-)	Reset button	14	Power LED (-)	
7	Ground		15	Power button	
8	Reset control		16	Ground	



**F\_USB1/F\_USB2: Headers for USB 2.0 Ports at Front Panel**

These headers allow user to connect additional USB cable on the PC front panel, and also can be connected with internal USB devices, like USB card reader.

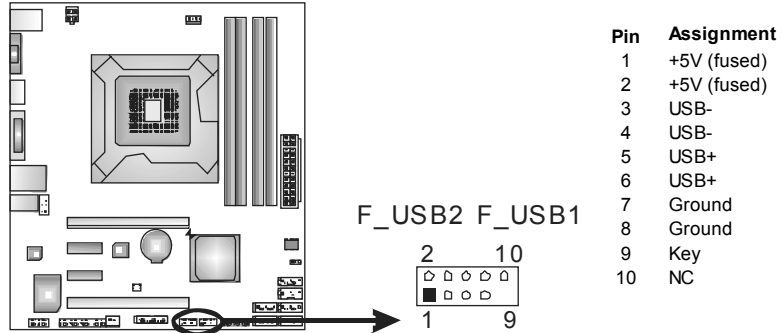

**JFRONT\_USB3\_1: Header for USB 3.0 Ports at Front Panel**

This header allows user to connect additional USB cable on the PC front panel, and also can be connected with internal USB devices, like USB card reader.

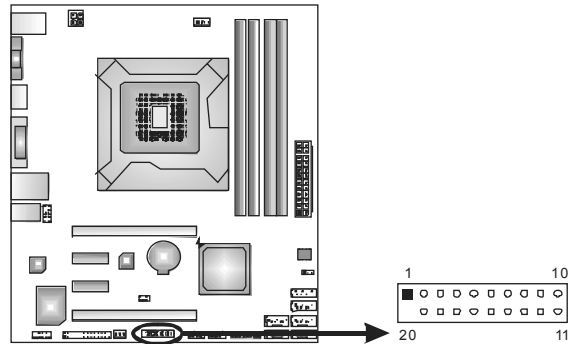

Pin	Assignment	Pin	Assignment
1	VBUS0	11	D2+
2	SSRX1-	12	D2-
3	SSRX1+	13	Ground
4	Ground	14	SSTX2+
5	SSTX1-	15	SSTX2-
6	SSTX1+	16	Ground
7	Ground	17	SSRX2+
8	D1-	18	SSRX2-
9	D1+	19	VBUS1
10	ID	20	Key

**NOTE:** USB3.0 is only supported by Windows 7.

### F\_AUDIO1: Front Panel Audio Header

This header allows user to connect the front audio output cable with the PC front panel. This header supports HD and AC'97 audio front panel connector.

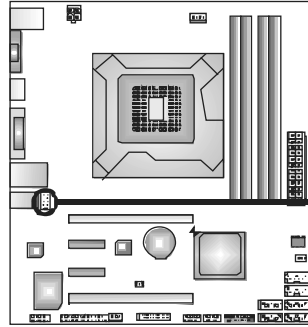

Pin	Assignment
1	Mic Left in
2	Ground
3	Mic Right in
4	GPIO
5	Right line in
6	Jack Sense
7	Front Sense
8	Key
9	Left line in
10	Jack Sense

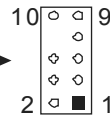

### CIR1: Consumer IR Connector

This header is for infrared remote control and communication.

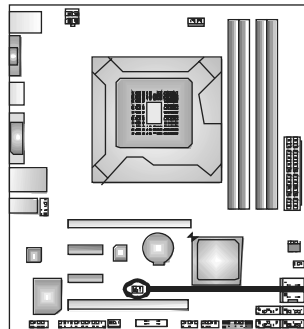

Pin	Assignment
1	IrDA serial input
2	Ground
3	Ground
4	Key
5	IrDA serial output
6	IR Power



**JCMOS1: Clear CMOS Header**

Placing the jumper on pin2-3 allows user to restore the BIOS safe setting and the CMOS data. Please carefully follow the procedures to avoid damaging the motherboard.

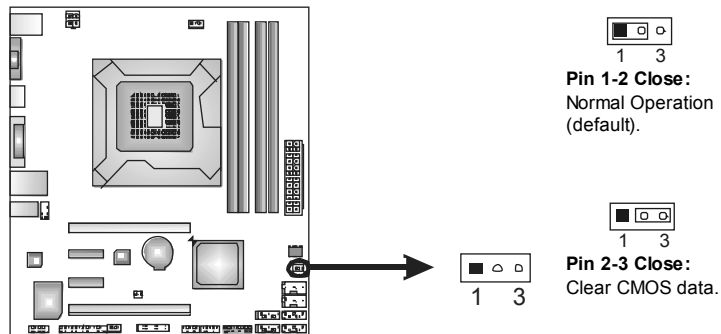

**※ Clear CMOS Procedures:**

1. Remove AC power line.
2. Set the jumper to "Pin 2-3 close".
3. Wait for five seconds.
4. Set the jumper to "Pin 1-2 close".
5. Power on the AC.
6. Reset your desired password or clear the CMOS data.

**J\_COM1: Serial Port Connector**

The motherboard has a Serial Port Connector for connecting RS-232 Port.

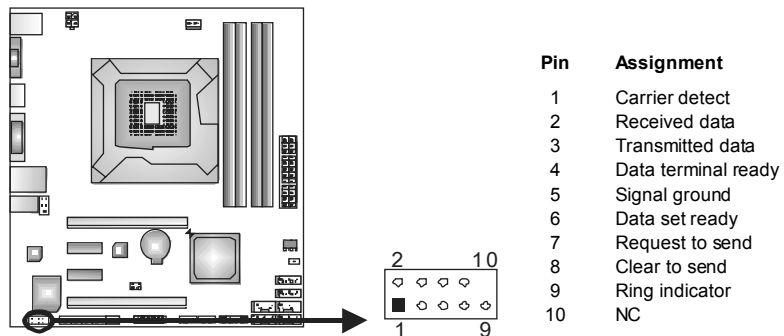

### J\_PRINT1: Printer Port Connector

This header allows you to connector printer on the PC.

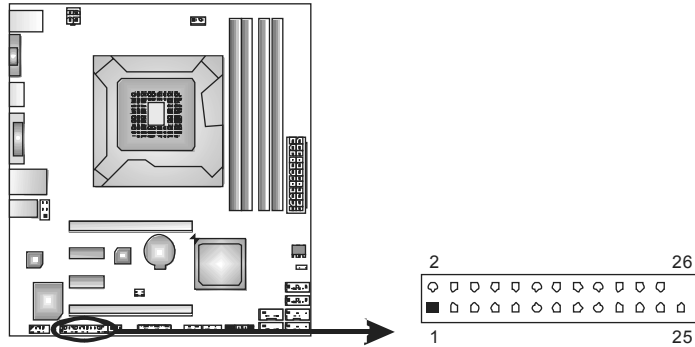

Pin	Assignment	Pin	Assignment
1	-Strobe	14	Ground
2	-ALF	15	Data 6
3	Data 0	16	Ground
4	-Error	17	Data 7
5	Data 1	18	Ground
6	-Init	19	-ACK
7	Data 2	20	Ground
8	-Sctlin	21	Busy
9	Data 3	22	Ground
10	Ground	23	PE
11	Data 4	24	Ground
12	Ground	25	SCLT
13	Data 5	26	Key

---

---

## CHAPTER 4: RAID FUNCTIONS

### 4.1 OPERATING SYSTEM

Supports Windows Vista and Windows 7.

### 4.2 RAID ARRAYS

RAID supports the following types of RAID arrays:

**RAID 0:** RAID 0 defines a disk striping scheme that improves disk read and write times for many applications.

**RAID 1:** RAID 1 defines techniques for mirroring data.

**RAID 10:** RAID 10 combines the techniques used in RAID 0 and RAID 1.

**RAID 5:** RAID 5 provides fault tolerance and better utilization of disk capacity.

### 4.3 How RAID WORKS

#### RAID 0:

The controller “stripes” data across multiple drives in a RAID 0 array system. It breaks up a large file into smaller blocks and performs disk reads and writes across multiple drives in parallel. The size of each block is determined by the stripe size parameter, which you set during the creation of the RAID set based on the system environment. This technique reduces overall disk access time and offers high bandwidth.

#### Features and Benefits

- **Drives:** Minimum 2, and maximum is up to 6 or 8. Depending on the platform.
- **Uses:** Intended for non-critical data requiring high data throughput, or any environment that does not require fault tolerance.
- **Benefits:** provides increased data throughput, especially for large files. No capacity loss penalty for parity.
- **Drawbacks:** Does not deliver any fault tolerance. If any drive in the array fails, all data is lost.
- **Fault Tolerance:** No.

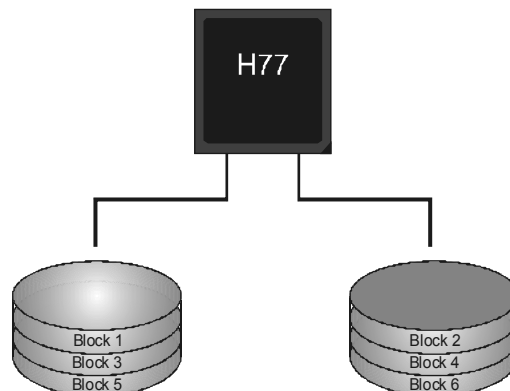

**RAID 1:**

Every read and write is actually carried out in parallel across 2 disk drives in a RAID 1 array system. The mirrored (backup) copy of the data can reside on the same disk or on a second redundant drive in the array. RAID 1 provides a hot-standby copy of data if the active volume or drive is corrupted or becomes unavailable because of a hardware failure. RAID techniques can be applied for high-availability solutions, or as a form of automatic backup that eliminates tedious manual backups to more expensive and less reliable media.

**Features and Benefits**

- **Drives:** Minimum 2, and maximum is 2.
- **Uses:** RAID 1 is ideal for small databases or any other application that requires fault tolerance and minimal capacity.
- **Benefits:** Provides 100% data redundancy. Should one drive fail, the controller switches to the other drive.
- **Drawbacks:** Requires 2 drives for the storage space of one drive. Performance is impaired during drive rebuilds.
- **Fault Tolerance:** Yes.

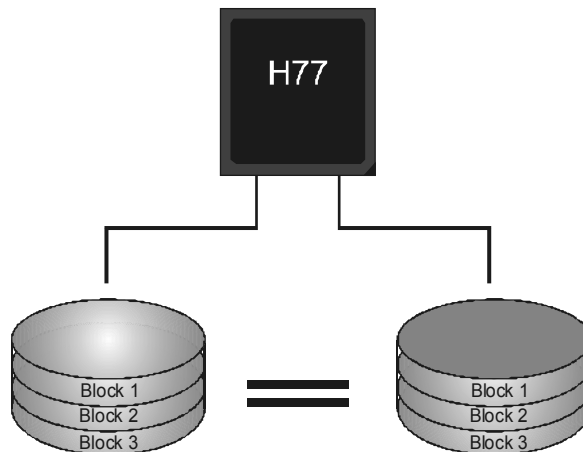

**RAID 10:**

RAID 1 drives can be striped using RAID 0 techniques. Resulting in a RAID 10 solution for improved resiliency, performance and rebuild performance.

**Features and Benefits**

- **Drives:** Minimum 4, and maximum is 6 or 8, depending on the platform.
- **Benefits:** Optimizes for both fault tolerance and performance, allowing for automatic redundancy. May be simultaneously used with other RAID levels in an array, and allows for spare disks.
- **Drawbacks:** Requires twice the available disk space for data redundancy, the same as RAID level 1.
- **Fault Tolerance:** Yes.

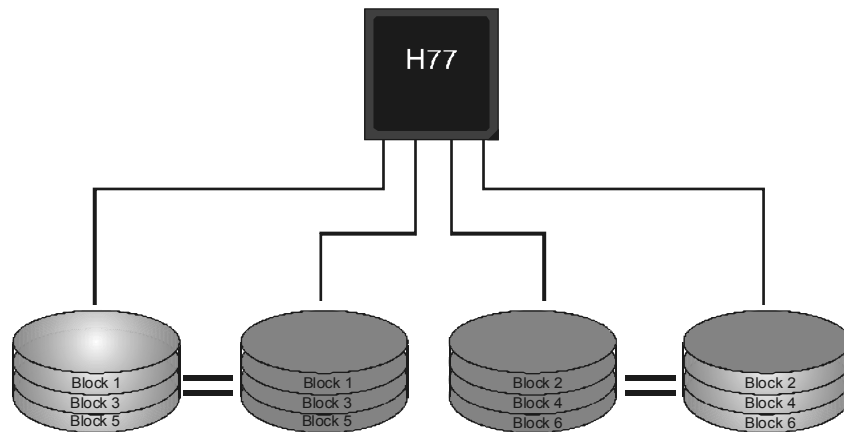

**RAID 5:**

RAID 5 stripes both data and parity information across three or more drives. It writes data and parity blocks across all the drives in the array. Fault tolerance is maintained by ensuring that the parity information for any given block of data is placed on a different drive from those used to store the data itself.

**Features and Benefits**

- **Drives:** Minimum 3.
- **Uses:** RAID 5 is recommended for transaction processing and general purpose service.
- **Benefits:** An ideal combination of good performance, good fault tolerance, and high capacity and storage efficiency.
- **Drawbacks:** Individual block data transfer rate same as a single disk. Write performance can be CPU intensive.
- **Fault Tolerance:** Yes.

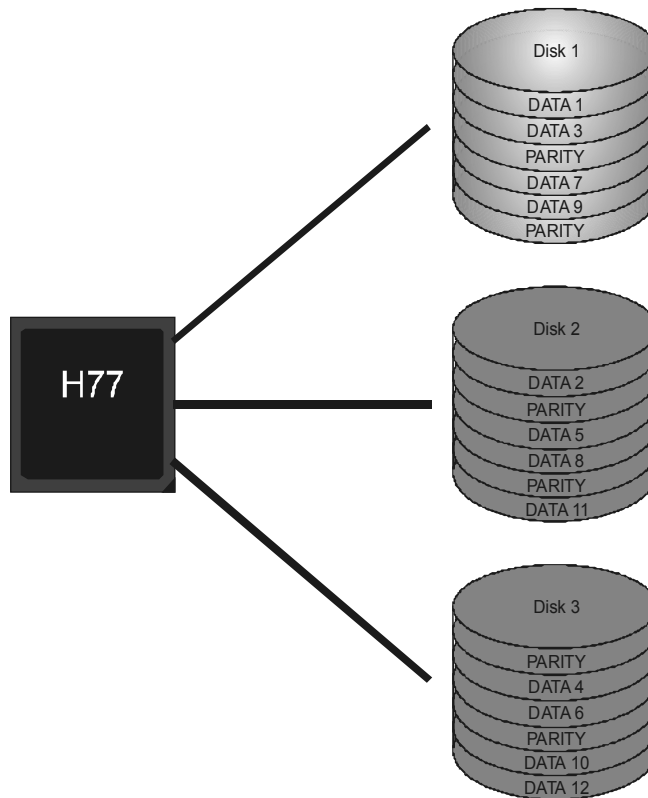



## CHAPTER 5: USEFUL HELP

### 5.1 DRIVER INSTALLATION NOTE

After you installed your operating system, please insert the Fully Setup Driver CD into your optical drive and install the driver for better system performance.

You will see the following window after you insert the CD

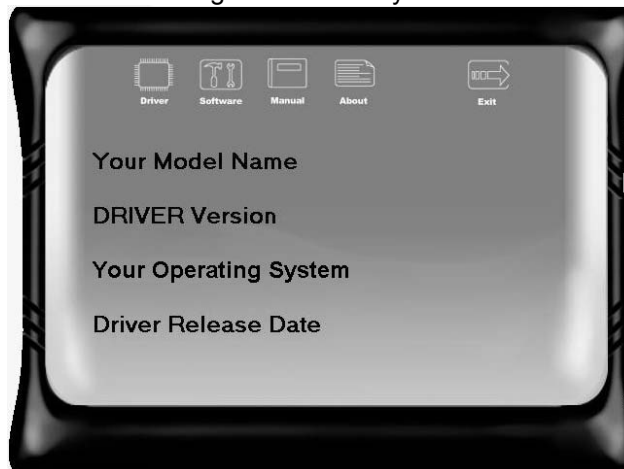

The setup guide will auto detect your motherboard and operating system.

**Note:**

If this window didn't show up after you insert the Driver CD, please use file browser to locate and execute the file **SETUP.EXE** under your optical drive.

#### A. Driver Installation

To install the driver, please click on the Driver icon. The setup guide will list the compatible driver for your motherboard and operating system. Click on each device driver to launch the installation program.

#### B. Software Installation

To install the software, please click on the Software icon. The setup guide will list the software available for your system, click on each software title to launch the installation program.

#### C. Manual

Aside from the paperback manual, we also provide manual in the Driver CD. Click on the Manual icon to browse for available manual.

**Note:**

You will need Acrobat Reader to open the manual file. Please download the latest version of Acrobat Reader software from <http://get.adobe.com/reader/>

## 5.2 SOFTWARE

### Installing Software

1. Insert the Setup CD to the optical drive. The drivers installation program would appear if the Autorun function has been enabled.
2. Select **Software Installation**, and then click on the respective software title.
3. Follow the on-screen instructions to complete the installation.

### Launching Software

After the installation process, you will see the software icon “eHOT Line” / “BIOS Update” appears on the desktop. Double-click the icon to launch the utility.

### eHot-Line (Optional)

eHot-Line is a convenient utility that helps you to contact with our Tech-Support system. This utility will collect the system information which is useful for analyzing the problem you may have encountered, and then send these information to our tech-support department to help you fix the problem.

 Before you use this utility, please set Outlook Express as your default e-mail client application program.

\*represents important information that you must provide. Without this information, you may not be able to send out the mail.

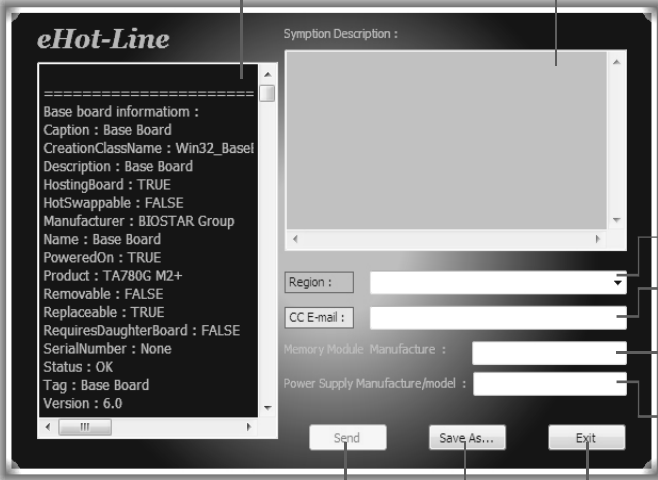

The screenshot shows the eHot-Line utility window. On the left, there is a list of system information under the heading "Base board information :". On the right, there is a "Symptom Description :" text area. Below these are several input fields: "Region :", "CC E-mail :", "Memory Module Manufacture :", and "Power Supply Manufacture/model :". At the bottom, there are three buttons: "Send", "Save As...", and "Exit".

Annotations for the screenshot:

- "This block will show the information which would be collected in the mail." points to the system information list.
- "\*Describe condition of your system." points to the Symptom Description text area.
- "\*Select your area or the area close to you." points to the Region dropdown menu.
- "Provide the e-mail address that you would like to send the copy to." points to the CC E-mail input field.
- "\*Provide the name of the memory module manufacturer." points to the Memory Module Manufacture input field.
- "Provide the name of the power supply manufacturer and the model no." points to the Power Supply Manufacture/model input field.
- "Send the mail out." points to the Send button.
- "Save these information to a .txt file" points to the Save As... button.
- "Exit this dialog." points to the Exit button.

After filling up this information, click **“Send”** to send the mail out. A warning dialog would appear asking for your confirmation; click **“Send”** to confirm or **“Do Not Send”** to cancel.



If you want to save this information to a .txt file, click **“Save As...”** and then you will see a saving dialog appears asking you to enter file name.

Enter the file name and then click **“Save”**. Your system information will be saved to a .txt file.

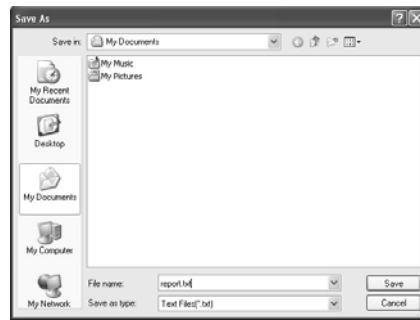

Open the saved .txt file, you will see your system information including motherboard/BIOS/CPU/video/device/OS information. This information is also concluded in the sent mail.



**We will not share customer’s data with any other third parties,** so please feel free to provide your system information while using eHot-Line service.



If you are not using Outlook Express as your default e-mail client application, you may need to save the system information to a .txt file and send the file to our tech support with other e-mail application. Go to the following web <http://www.biostar.com.tw/app/en-us/about/contact.php> for getting our contact information.

## BIOS Update

BIOS Update is a convenient utility which allows you to update your motherboard BIOS under Windows system.

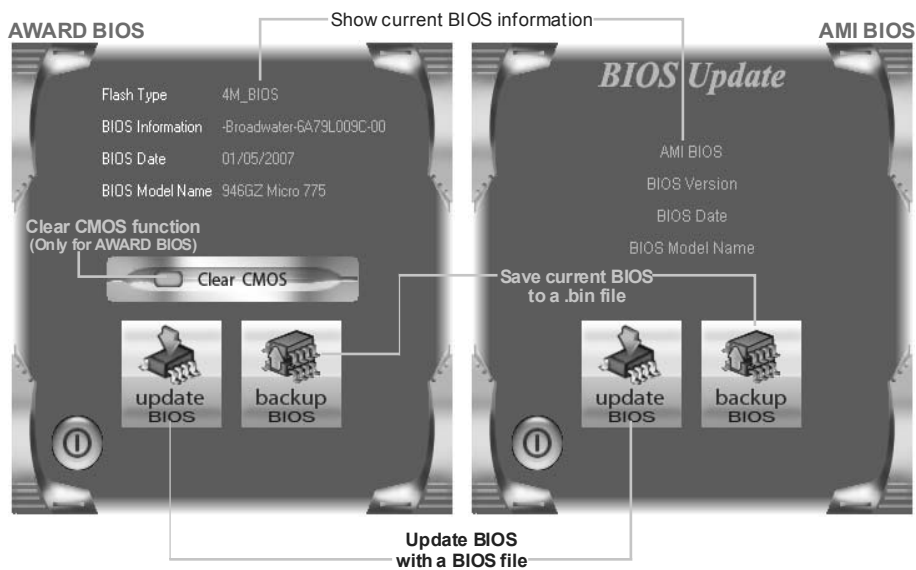

### <Backup BIOS>

Once click on this button, the saving dialog will show. Choose the position to save file and enter file name. (We recommend that the file name should be English/number and no longer than 7 characters.) Then click **Save**.

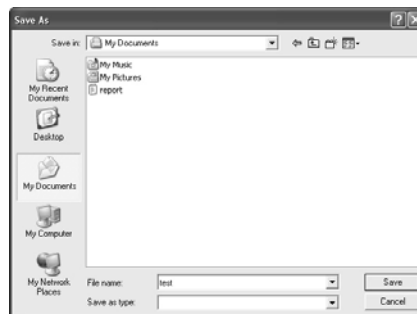

**<Update BIOS>**

Before doing this, please download the proper BIOS file from the website.

For AWARD BIOS, update BIOS procedure should be run with Clear CMOS function, so please check on Clear CMOS first.

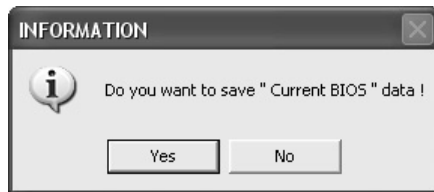

Then click Update BIOS button, a dialog will show for asking you backup current BIOS. Click **Yes** for BIOS backup and refer to the Backup BIOS procedure; or click **No** to skip this procedure.

After the BIOS Backup procedure, the open dialog will show for requesting the BIOS file which is going to be updated. Please choose the proper BIOS file for updating, then click on **Open**.

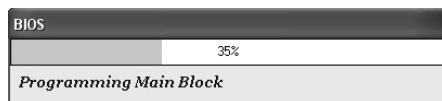
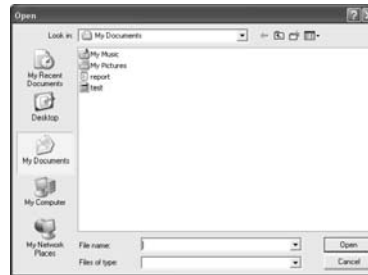

The utility will update BIOS with the proper BIOS file, and this process may take minutes. Please do not open any other applications during this process.

After the BIOS Update process, click on **OK** to restart the system.

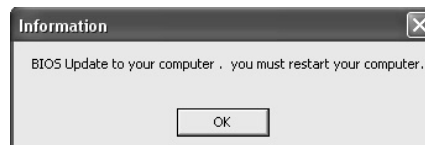

While the system boots up and the full screen logo shows, press <Delete> key to enter BIOS setup.

In the BIOS setup, use the **Load Optimized Defaults** function and then **Save and Exit Setup** to exit BIOS setup. BIOS Update is completed.



All the information and content above about the software are subject to be changed without notice. For better performance, the software is being continuously updated. The information and pictures described above are for your reference only. The actual information and settings on board may be slightly different from this manual.

## 5.3 EXTRA INFORMATION

### ***CPU Overheated***

If the system shuts down automatically after system is powered on for seconds, the phenomenon means the CPU protection function has been activated.

When the CPU is over heated, the motherboard will shutdown automatically to avoid a damage of the CPU, and the system may not power on again.

In this case, please double check:

1. The CPU cooler surface is placed evenly with the CPU surface.
2. CPU fan is rotated normally.
3. CPU fan speed is fulfilling with the CPU speed.

After confirmed, please follow steps below to relief the CPU protection function.

1. Remove the power cord from power supply for seconds.
2. Wait for seconds.
3. Plug in the power cord and boot up the system.

Or you can:

1. Clear the CMOS data.  
(See "Close CMOS Header: JCMOS1" section)
2. Wait for seconds.
3. Power on the system again.

## 5.4 AMI BIOS BEEP CODE

### Boot Block Beep Codes

Number of Beeps	Description
1	No media present. (Insert diskette in floppy drive A:)
2	"AMIBOOT.ROM" file not found in root directory of diskette in A:
3	Insert next diskette if multiple diskettes are used for recovery
4	Flash Programming successful
5	File read error
7	No Flash EPROM detected
10	Flash Erase error
11	Flash Program error
12	"AMIBOOT.ROM" file size error
13	BIOS ROM image mismatch (file layout does not match image present in flash device)

### POST BIOS Beep Codes

Number of Beeps	Description
1	Memory refresh timer error
3	Base memory read/write test error
6	Keyboard controller BAT command failed
7	General exception error (processor exception interrupt error)
8	Display memory error (system video adapter)

### Troubleshooting POST BIOS Beep Codes

Number of Beeps	Troubleshooting Action
1, 3	Reseat the memory, or replace with known good modules.
6, 7	<p>Fatal error indicating a serious problem with the system. Consult your system manufacturer. Before declaring the motherboard beyond all hope, eliminate the possibility of interference by a malfunctioning add-in card. Remove all expansion cards except the video adapter.</p> <ul style="list-style-type: none"> <li>● If beep codes are generated when all other expansion cards are absent, consult your system manufacturer's technical support.</li> <li>● If beep codes are not generated when all other expansion cards are absent, one of the add-in cards is causing the malfunction. Insert the cards back into the system one at a time until the problem happens again. This will reveal the malfunctioning card.</li> </ul>
8	If the system video adapter is an add-in card, replace or reseat the video adapter. If the video adapter is an integrated part of the system board, the board may be faulty.

## 5.5 TROUBLESHOOTING

Probable	Solution
<ol style="list-style-type: none"> <li>1. There is no power in the system. Power LED does not shine; the fan of the power supply does not work</li> <li>2. Indicator light on keyboard does not shine.</li> </ol>	<ol style="list-style-type: none"> <li>1. Make sure power cable is securely plugged in.</li> <li>2. Replace cable.</li> <li>3. Contact technical support.</li> </ol>
<p>System is inoperative. Keyboard lights are on, power indicator lights are lit, and hard drives are running.</p>	<p>Using even pressure on both ends of the DIMM, press down firmly until the module snaps into place.</p>
<p>System does not boot from a hard disk drive, but can be booted from optical drive.</p>	<ol style="list-style-type: none"> <li>1. Check cable running from disk to disk controller board. Make sure both ends are securely plugged in; check the drive type in the standard CMOS setup.</li> <li>2. Backing up the hard drive is extremely important. All hard disks are capable of breaking down at any time.</li> </ol>
<p>System only boots from an optical drive. Hard disks can be read, applications can be used, but system fails to boot from a hard disk.</p>	<ol style="list-style-type: none"> <li>1. Back up data and applications files.</li> <li>2. Reformat the hard drive. Re-install applications and data using backup disks.</li> </ol>
<p>Screen message shows "Invalid Configuration" or "CMOS Failure."</p>	<p>Review system's equipment. Make sure correct information is in setup.</p>
<p>System cannot boot after user installs a second hard drive.</p>	<ol style="list-style-type: none"> <li>1. Set master/slave jumpers correctly.</li> <li>2. Run SETUP program and select correct drive types. Call the drive manufacturers for compatibility with other drives.</li> </ol>



This page is intentionally left blank.

## APPENDIX: SPEC IN OTHER LANGUAGES

### GERMAN

<i>Spezifikationen</i>		
CPU	Socket 1155 Intel Core i7 / i5 / i3 / Pentium / Celeron Prozessoren	Unterstützt Execute Disable Bit / Enhanced Intel SpeedStep® / Intel Architecture-64 / Extended Memory 64 Technology / Virtualization Technology / Hyper Threading
Chipsatz	Intel H77	
Super E/A	IT8728 Bietet die häufig verwendeten alten Super E/A-Funktionen. Low Pin Count-Schnittstelle	Umgebungskontrolle, Hardware-Überwachung Lüfterdrehzahl-Controller/-Überwachung "Smart Guardian"-Funktion von ITE
Arbeitsspeicher	DDR3 DIMM-Steckplätze x 4 Max. 32GB Arbeitsspeicher Jeder DIMM unterstützt 512MB/1GB/2GB/4GB/8GB DDR3.	Dual-Kanal DDR3 Speichermodul Unterstützt DDR3 1066 / 1333 Unterstützt DDR3 1600 (abhängig von CPU) registrierte DIMMs. ECC DIMMs werden nicht unterstützt.
SATA 2 & 3	Integrierter Serial ATA-Controller	Datenübertragungsraten bis zu 3.0Gb/s / 6.0Gb/s. Konform mit der SATA-Spezifikation Version 2.0 / 3.0 Unterstützt RAID 0,1,5,10, SRT
LAN	Realtek RTL 8111E	10 / 100 / 1000 Mb/s Auto-Negotiation Halb- / Vollduplex-Funktion
HD Audio-Unterstützung	ALC662	Unterstützt High-Definition Audio 5.1-Kanal-Audioausgabe
USB3.0	H77	Datenübertragungsraten bis zu 600 MB / s
Steckplätze	PCI Express Gen3 x16 Steckplatz x1 PCI Express Gen2 x16 Steckplatz(x4) x1 PCI Express Gen2 x 1-Steckplatz x2	
Onboard-Anschluss	SATA3-Anschluss x2 SATA2-Anschluss x4 Fronttafelanschluss x1	Jeder Anschluss unterstützt 1 SATA3-Laufwerk Jeder Anschluss unterstützt 1 SATA2-Laufwerk Unterstützt die Fronttafelanforderungen

<b>Spezifikationen</b>			
	Front-Audioanschluss	x1	Unterstützt die Fronttafel-Audioanschlussfunktion
	CPU-Lüfter-Sockel	x1	CPU-Lüfterstromversorgungsanschluss (mit Smart Fan-Funktion)
	System-Lüfter-Sockel	x1	System-Lüfter-Stromversorgungsanschluss
	"CMOS löschen"-Sockel	x1	
	USB2.0-Anschluss	x2	Jeder Anschluss unterstützt 2 Fronttafel-USB2.0-Anschlüsse
	USB3.0-Anschluss	x1	Jeder Anschluss unterstützt 2 Fronttafel-USB3.0-Anschlüsse
	Verbraucher-IR Anschluss	x1	
	Druckeranschluss Anschluss	x1	Jeder Anschluss unterstützt 1 Druckeranschluss
	Serieller Anschluss	x1	
	Stromanschluss (24-polig)	x1	
	Stromanschluss (4-polig)	x1	
Rückseiten-E /A	PS/2-Tastatur	x1	
	HDMI-Anschluss	x1	
	VGA-Anschluss	x1	
	DVI-Anschluss	x1	
	LAN-Anschluss	x1	
	USB2.0-Anschluss	x2	
	USB3.0-Anschluss	x2	
	Audioanschluss	x3	
Platinengröße	220 mm (B) X 244 mm (L)		ATX
OS-Unterstützung	Windows XP / Vista / 7		Biostar behält sich das Recht vor, ohne Ankündigung die Unterstützung für ein Betriebssystem hinzuzufügen oder zu entfernen.

**FRENCH**

SPEC		
UC	Socket 1155 Processeurs Intel Core i7 / i5 / i3 / Pentium / Celeron	Prend en charge les technologies d'exécution de bit de désactivation / Intel SpeedStep® optimisée/ d'architecture Intel 64 / de mémoire étendue 64 / de virtualisation / Hyper Threading
Chipset	Intel H77	
Super E/S	IT8728 Fournit la fonctionnalité de Super E/S patrimoniales la plus utilisée. Interface à faible compte de broches	Initiatives de contrôle environnementales, Moniteur de matériel Contrôleur /moniteur de vitesse de ventilateur Fonction "Gardien intelligent" de l'ITE
Mémoire principale	Fentes DDR3 DIMM x 4 Capacité mémoire maximale de 32 Go Chaque DIMM prend en charge des DDR3 de 512Mo/1Go/2Go/4Go/8Go	Module de mémoire DDR3 à mode à double voie Prend en charge la DDR3 1066 / 1333 Prend en charge la DDR3 1600 (dépend du CPU) Les DIMM à registres et DIMM avec code correcteurs d'erreurs ne sont pas prises en charge
SATA 2 & 3	Contrôleur Serial ATA intégré :	Taux de transfert jusqu'à 3.0Go/s / 6.0Go/s. Conforme à la spécification SATA Version 2.0 / 3.0 Prise en charge RAID 0,1,5,10, SRT
LAN	Realtek RTL 8111E	10 / 100 / 1000 Mb/s négociation automatique Half / Full duplex capability
Prise en charge audio HD	ALC662	Prise en charge de l'audio haute définition Sortie audio à 5.1 voies
USB3.0	H77	Taux de transfert de données jusqu'à 600 Mo / s
Fentes	Fente PCI Express Gen3 x16 x1 Fente PCI Express Gen2 x16(x4) x1 Fente PCI Express Gen2 x1 x2	
Connecteur embarqué	Connecteur SATA3 x2 Connecteur SATA2 x4	Chaque connecteur prend en charge 1 périphérique SATA3 Chaque connecteur prend en charge 1 périphérique SATA2

SPEC			
	Connecteur du panneau avant	x1	Prend en charge les équipements du panneau avant
	Connecteur Audio du panneau avant	x1	Prend en charge la fonction audio du panneau avant
	Embase de ventilateur UC	x1	Alimentation électrique du ventilateur UC (avec fonction de ventilateur intelligent)
	Embase de ventilateur système	x1	Alimentation électrique du ventilateur système
	Embase d'effacement CMOS	x1	
	Connecteur USB2.0	x2	Chaque connecteur prend en charge 2 ports USB2.0 de panneau avant
	Connecteur USB3.0	x1	Chaque connecteur prend en charge 2 ports USB3.0 de panneau avant
	Connecteur de IR du consommateur	x1	
	Connecteur de Port d'imprimante	x1	Chaque connector prend en charge 1 Port d'imprimante
	Port série	x1	
	Connecteur d'alimentation (24 broches)	x1	
	Connecteur d'alimentation (4 broches)	x1	
E/S du panneau arrière	Clavier PS/2	x1	
	Port HDMI	x1	
	Port VGA	x1	
	Port DVI	x1	
	Port LAN	x1	
	Port USB2.0	x2	
	Port USB3.0	x2	
	Fiche audio	x3	
Dimensions de la carte	220 mm (l) X 244 mm (H)		ATX
Support SE	Windows XP / Vista / 7		Biostar se réserve le droit d'ajouter ou de supprimer le support de SE avec ou sans préavis

**ITALIAN**

<b>SPECIFICA</b>		
CPU	Socket 1155 Processore Intel Core i7 / i5 / i3 / Pentium / Celeron	Supporto di Execute Disable Bit / Enhanced Intel SpeedStep® / Architettura Intel 64 / Tecnologia Extended Memory 64 / Tecnologia Virtualization / Hyper Threading
Chipset	Intel H77	
Super I/O	IT8728 Fornisce le funzionalità legacy Super I/O usate più comunemente. Interfaccia LPC (Low Pin Count)	Funzioni di controllo dell'ambiente: Monitoraggio hardware Controller / Monitoraggio velocità ventolina Funzione "Smart Guardian" di ITE
Memoria principale	Alloggi DIMM DDR3 x 4 Capacità massima della memoria 32GB Ciascun DIMM supporta DDR3 512MB/1GB/2GB/4GB/8GB	Modulo di memoria DDR3 a canale doppio Supporto di DDR3 1066 / 1333 Supporto di DDR3 1600 (dipende dalla CPU) DIMM registrati e DIMM ECC non sono supportati
SATA 2 & 3	Controller Serial ATA integrato	Velocità di trasferimento dei dati fino a 3.0Gb/s / 6.0Gb/s. Compatibile specifiche SATA Versione 2.0/3.0 Supporto RAID 0,1,5,10, SRT
LAN	Realtek RTL 8111E	Negoziazione automatica 10 / 100 / 1000 Mb/s Capacità Half / Full Duplex
Supporto audio HD	ALC662	Supporto audio High-Definition (HD) Uscita audio 5.1 canali
USB3.0	H77	Velocità di trasferimento dati fino a 600 MB / s
Alloggi	Alloggio PCI Express Gen3 x16 x1 Alloggio PCI Express Gen2 x16(x4) x1 Alloggio PCI Express Gen2 x1 x2	
Connettori su scheda	Connettore SATA3 x2 Connettore SATA2 x4 Connettore pannello frontale x1 Connettore audio frontale x1	Ciascun connettore supporta 1 unità SATA3 Ciascun connettore supporta 1 unità SATA2 Supporta i servizi del pannello frontale Supporta la funzione audio pannello frontale

<b>SPECIFICA</b>			
	Collettore ventolina CPU	x1	Alimentazione ventolina CPU (con funzione Smart Fan)
	Collettore ventolina sistema	x1	Alimentazione ventolina di sistema
	Collettore cancellazione CMOS	x1	
	Connettore USB2.0	x2	Ciascun connettore supporta 2 porte USB2.0 pannello frontale
	Connettore USB3.0	x1	Ciascun connettore supporta 2 porte USB3.0 pannello frontale
	Connettore IR del consumatore	x1	
	Connettore Porta stampante	x1	Ciascun connettore supporta 1 Porta stampante
	Porta seriale	x1	
	Connettore alimentazione (24 pin)	x1	
	Connettore alimentazione (4 pin)	x1	
I/O pannello posteriore	Tastiera PS/2	x1	
	Porta HDMI	x1	
	Porta VGA	x1	
	Porta DVI	x1	
	Porta LAN	x1	
	Porta USB2.0	x2	
	Porta USB3.0	x2	
	Connettore audio	x3	
Dimensioni scheda	220 mm (larghezza) x 244 mm (altezza)		ATX
Sistemi operativi supportati	Windows XP / Vista / 7		Biostar si riserva il diritto di aggiungere o rimuovere il supporto di qualsiasi sistema operativo senza preavviso.

**SPANISH**

<b>Especificación</b>		
CPU	Socket 1155 Procesador Intel Core i7 / i5 / i3 / Pentium / Celeron	Admite Bit de deshabilitación de ejecución / Intel SpeedStep® Mejorado / Intel Architecture-64 / Tecnología Extended Memory 64 / Tecnología de virtualización / Hyper Threading
Conjunto de chips	Intel H77	
Súper E/S	IT8728 Le ofrece las funcionalidades heredadas de uso más común Súper E/S. Interfaz de cuenta Low Pin	Iniciativas de control de entorno, Monitor hardware Controlador/monitor de velocidad de ventilador Función "Guardia inteligente" de ITE
Memoria principal	Ranuras DIMM DDR3 x 4 Capacidad máxima de memoria de 32GB Cada DIMM admite DDR de 512MB/1GB/2GB/4GB/8GB	Módulo de memoria DDR3 de canal Doble Admite DDR3 de 1066 / 1333 Admite DDR3 de 1600(depense de la CPU) No admite DIMM registrados o DIMM compatibles con ECC
SATA 2 & 3	Controlador ATA Serie Integrado	Tasas de transferencia de hasta 3.0 Gb/s / 6.0 Gb/s. Compatible con la versión SATA 2.0 / 3.0. Admite RAID 0,1,5,10, SRT
Red Local	Realtek RTL 8111E	Negociación de 10 / 100 / 1000 Mb/s Funciones Half / Full dúplex
Soporte de sonido HD	ALC662	Soporte de sonido de Alta Definición Salida de sonido de 5.1 canales
USB3.0	H77	Tasas de transferencia de datos hasta 600 MB / s
Ranuras	Ranura PCI Express Gen3 x16 X1 Ranura PCI Express Gen2 x16(x4) X1 Ranura PCI Express Gen2 x 1 X2	
Conectores en placa	Conector SATA3 X2 Conector SATA2 X4 Conector de panel frontal X1 Conector de sonido frontal X1	Cada conector soporta 1 dispositivos SATA3 Cada conector soporta 1 dispositivos SATA2 Soporta instalaciones en el panel frontal Soporta funciones de sonido en el panel frontal



<b>Especificación</b>			
	Cabecera de ventilador de CPU	X1	Fuente de alimentación de ventilador de CPU (con función Smart Fan)
	Cabecera de ventilador de sistema	X1	Fuente de alimentación de ventilador de sistema
	Cabecera de borrado de CMOS	X1	
	Conector USB2.0	X2	Cada conector soporta 2 puertos USB2.0 frontales
	Conector USB3.0	X1	Cada conector soporta 2 puertos USB3.0 frontales
	Conector de IR del consumidor	X1	
	Conector Puerto de impresora	X1	Cada conector soporta 1 Puerto de impresora
	Puerto serie	X1	
	Conector de alimentación (24 patillas)	X1	
	Conector de alimentación (4 patillas)	X1	
Panel trasero de E/S	Teclado PS/2	X1	
	Puerto HDMI	x1	
	Puerto VGA	X1	
	Puerto DVI	X1	
	Puerto de red local	X1	
	Puerto USB2.0	X2	
	Puerto USB3.0	X2	
	Conector de sonido	X3	
Tamaño de la placa	220 mm. (A) X 244 Mm. (H)		ATX
Soporte de sistema operativo	Windows XP / Vista / 7		Biostar se reserva el derecho de añadir o retirar el soporte de cualquier SO con o sin aviso previo.

**PORTUGUESE**

<b>ESPECIFICAÇÕES</b>		
CPU	Socket 1155 Processador Intel Core i7 / i5 / i3 / Pentium / Celeron	Suporta as tecnologias Execute Disable Bit / Enhanced Intel SpeedStep® / Intel Architecture -64 / Extended Memory 64 / Virtualization / Hyper Threading
Chipset	Intel H77	
Especificação do Super I/O	IT8728 Proporciona as funcionalidades mais utilizadas em termos da especificação Super I/O. Interface LPC (Low Pin Count).	Iniciativas para controlo do ambiente Monitorização do hardware Controlador/Monitor da velocidade da ventoinha Função "Smart Guardian" da ITE
Memória principal	Ranuras DIMM DDR3 x 4 Capacidade máxima de memória: 32 GB Cada módulo DIMM suporta uma memória DDR3 de 512MB/ 1GB/2GB/4GB/8GB	Módulo de memória DDR3 de canal duplo Suporta módulos DDR3 1066 / 1333 Suporta módulos DDR3 1600 (depende de CPU) Os módulos DIMM registados e os DIMM ECC não são suportados
SATA 2 & 3	Controlador Serial ATA integrado	Velocidades de transmissão de dados até 3.0 Gb/s / 6.0 Gb/s. Compatibilidade com a especificação SATA versão 2.0 / 3.0. Suporta as funções RAID 0,1,5,10, SRT
LAN	Realtek RTL 8111E	Auto negociação de 10 / 100 / 1000 Mb/s Capacidade semij/full-duplex
Suporte para áudio de alta definição	ALC662	Suporta a especificação High-Definition Audio Saída de áudio de 5.1 canais
USB3.0	H77	Taxas de transferência de dados até 600 MB / s
Ranuras	Ranura PCI Express Gen3 x16 x1 Ranura PCI Express Gen2 x16(x4) x1 Ranura PCI Express Gen2 x 1 x2	
Conectores	Conector SATA3 x2 Conector SATA2 x4	Cada conector suporta 1 dispositivo SATA3 Cada conector suporta 1 dispositivo SATA2

<b>ESPECIFICAÇÕES</b>			
na placa	Conector do painel frontal	x1	Para suporte de várias funções no painel frontal
	Conector de áudio frontal	x1	Suporta a função de áudio no painel frontal
	Conector da ventoinha da CPU	x1	Alimentação da ventoinha da CPU (com a função Smart Fan)
	Conector da ventoinha do sistema	x1	Alimentação da ventoinha do sistema
	Conector para limpeza do CMOS	x1	
	Conector USB2.0	x2	Cada conector suporta 2 portas USB2.0 no painel frontal
	Conector USB3.0	x1	Cada conector suporta 2 portas USB3.0 no painel frontal
	Conector de IR do consumidor	x1	
	Conector da para impressora	x1	Cada conector suporta 1 Porta para impressora
	Porta série	x1	
	Conector de alimentação (24 pinos)	x1	
	Conector de alimentação (4 pinos)	x1	
Entradas/Saídas no painel traseiro	Teclado PS/2	x1	
	Porta HDMI	x1	
	Porta VGA	x1	
	Porta DVI	x1	
	Porta LAN	x1	
	Porta USB2.0	x2	
	Porta USB3.0	x2	
	Tomada de áudio	x3	
Tamanho da placa	220 mm (L) X 244 mm (A)		ATX
Sistemas operativos suportados	Windows XP / Vista / 7		A Biostar reserva-se o direito de adicionar ou remover suporte para qualquer sistema operativo com ou sem aviso prévio.

**POLISH**

SPEC		
Procesor	Socket 1155 Procesor Intel Core i7 / i5 / i3 / Pentium / Celeron	Obsługa Execute Disable Bit / Enhanced Intel SpeedStep® / Intel Architecture-64 / Extended Memory 64 Technology / Virtualization Technology / Hyper Threading
Chipset	Intel H77	
Pamięć główna	Gniazda DDR3 DIMM x 4 Maks. wielkość pamięci 32GB Każde gniazdo DIMM obsługuje moduły 512MB/1GB/2GB/4GB/8GB DDR3	Moduł pamięci DDR3 z trybem podwójnego kanału Obsługa DDR3 1066 / 1333 Obsługa DDR3 1600 (zależy od CPU) Brak obsługi Registered DIMM oraz ECC DIMM
Super I/O	IT8728 Zapewnia najbardziej powszechne funkcje Super I/O. Interfejs Low Pin Count	Funkcje kontroli warunków pracy, Monitor H/W Kontroler/Monitor prędkości wentylatora Funkcja ITE "Smart Guardian"
SATA 2 & 3	Zintegrowany kontroler Serial ATA	Transfer danych do 3.0 Gb/s / 6.0 Gb/s. Zgodność ze specyfikacją SATA w wersji 2.0 / 3.0. Obsługa RAID 0,1,5,10, SRT
LAN	Realtek RTL 8111E	10 / 100 / 1000 Mb/s z automatyczną negocjacją szybkości Działanie w trybie połowicznego / pełnego duplexu
Obsługa audio HD	ALC662	Obsługa High-Definition Audio 5.1 kanałowe wyjście audio
USB3.0	H77	Cena transferu danych do 600 MB / s
Gniazda	Gniazdo PCI Express Gen3 x16 x1 Gniazdo PCI Express Gen2 x16(x4) x1 Gniazdo PCI Express Gen2 x 1 x2	
Złącza wbudowane	Złącze SATA3 x2 Złącze SATA2 x4 Złącze panela przedniego x1 Przednie złącze audio x1	Każde złącze obsługuje 1 urządzenie SATA3 Każde złącze obsługuje 1 urządzenie SATA2 Obsługa elementów panela przedniego Obsługa funkcji audio na panelu przednim

<b>SPEC</b>		
	Złącze główkowe wentylatora procesora x1	Zasilanie wentylatora procesora (z funkcją Smart Fan)
	Złącze główkowe wentylatora systemowego x1	Zasilanie wentylatora systemowego
	Złącze główkowe kasowania CMOS x1	
	Złącze USB2.0 x2	Każde złącze obsługuje 2 porty USB2.0 na panelu przednim
	Złącze USB3.0 x1	Każde złącze obsługuje 2 porty USB3.0 na panelu przednim
	Złącze Konsument IR x1	
	Złącze Port drukarki x1	Każde złącze obsługuje 1 Port drukarki
	Port szeregowy x1	
	Złącze zasilania (24 pinowe) x1	
	Złącze zasilania (4 pinowe) x1	
Back Panel I/O	Klawiatura PS/2 x1	
	Port HDMI x1	
	Port VGA x1	
	Port DVI x1	
	Port LAN x1	
	Port USB2.0 x2	
	Port USB3.0 x2	
	Gniazdo audio x3	
Wymiary płyty	220 mm (S) X 244 mm (W)	ATX
Obsługa systemu operacyjnego	Windows XP / Vista / 7	Biostar zastrzega sobie prawo dodawania lub odwoływania obsługi dowolnego systemu operacyjnego bez powiadomienia.

**RUSSIAN**

<b>СПЕЦ</b>		
CPU (центральный процессор)	Socket 1155 Процессор Intel Core i7 / i5 / i3 / Pentium / Celeron	Поддержка технологий Execute Disable Bit / Enhanced Intel SpeedStep® / Intel Architecture-64 / Extended Memory 64 Technology / технологии виртуализация / Hyper Threading
Набор микросхем	Intel H77	
Основная память	Слоты DDR3 DIMM x 4 Максимальная ёмкость памяти 32 ГБ Каждый модуль DIMM поддерживает 512МБ/1ГБ/2ГБ/4ГБ/8 ГБ DDR3	Модуль памяти с двухканальным режимом DDR3 Поддержка DDR3 1066 / 1333 Поддержка DDR3 1600(в зависимости от процессора) Не поддерживает зарегистрированные модули DIMM and ECC DIMM
Super I/O	IT8728 Обеспечивает наиболее используемые действующие функциональные возможности Super I/O. Интерфейс с низким количеством выводов	Инициативы по охране окружающей среды, Аппаратный монитор Регулятор скорости вентилятора/ монитор Функция ITE "Smart Guardian" (Интеллектуальная защита)
SATA 2 & 3	Встроенное последовательное устройство управления ATA	скорость передачи данных до 3.0 гигабит/с / 6.0 гигабит/с. Соответствие спецификации SATA версия 2.0/3.0 Поддержка RAID 0,1,5,10, SRT
Локальная сеть	Realtek RTL 8111E	Автоматическое согласование 10 / 100 / 1000 Мб/с Частичная / полная дуплексная способность
Звуковая поддержка жесткого диска	ALC662	Звуковая поддержка High-Definition 5.1канальный звуковой выход
USB3.0	H77	скорости передачи данных до 600 МБ / с
Слоты	Слот PCI Express Gen3 x16 x1 Слот PCI Express Gen2 x16(x4) x1 Слот PCI Express Gen2 x 1 x2	
Встроенный разъём	Разъём SATA3 x2 Разъём SATA2 x4 Разъём на лицевой панели x1 Входной звуковой разъём x1	Каждый разъём поддерживает 1 устройство SATA3 Каждый разъём поддерживает 1 устройство SATA2 Поддержка устройств на лицевой панели Поддержка звуковых функций на лицевой панели

СПЕЦ		
	Контактирующее приспособление вентилятора центрального процессора x1	Источник питания для вентилятора центрального процессора (с функцией интеллектуального вентилятора)
	Контактирующее приспособление вентилятора системы x1	Источник питания для вентилятора системы
	Открытое контактирующее приспособление CMOS x1	
	USB2.0-разъём x2	Каждый разъём поддерживает 2 USB2.0-порта на лицевой панели
	USB3.0-разъём x1	Каждый разъём поддерживает 2 USB3.0-порта на лицевой панели
	Разъём едока ИКБЙ x1	
	Разъём Порт подключения принтера x1	Каждый разъём поддерживает 1 Порт подключения принтера
	Последовательный порт x1	
	Разъем питания (24 вывод) x1	
	Разъем питания (4 вывод) x1	
Задняя панель средств ввода-вывода	Клавиатура PS/2 x1	
	Порт HDMI x1	
	Порт VGA x1	
	Порт DVI x1	
	Порт LAN x1	
	USB2.0-порт x2	
	USB3.0-порт x2	
	Гнездо для подключения наушников x3	
Размер панели	220 мм (Ш) X 244 мм (В)	ATX
Поддержка OS	Windows XP / Vista / 7	Biostar сохраняет за собой право добавлять или удалять средства обеспечения для OS с или без предварительного уведомления.

## ARABIC

المواصفات		
Execute Disable Bit / Enhanced Intel SpeedStep® / Intel Architecture-64 / Extended Memory 64 Technology / Virtualization Technology / Hyper Threading	Socket 1155 Intel Core i7 / i5 / i3 / Pentium / Celeron يتردد يصل إلى	وحدة المعالجة المركزية
	Intel H77	مجموعة الشرائح
عدد4 قحة DDR3 DIMM سعة ذاكرة قصوى 32 جيجا بايت ميجا بايت و 1/512/سعة DDR3 تدعم ذاكرة من نوع DIMM تدعم كل قحة و2/4 و8 جيجا بايت	مزودة لقارة DDR3 وحدة ذاكرة سعت 1333 / 1066 ميجا بايت تدعم الذاكرة من نوع على يعتمد) 1600 سعرات DDR3 نوع من الذاكرة تدعم بايت ميجا (المركزية المعالجة وحدة ECC وتلك التي لا تتوافق مع DIMM لا تدعم رقائق الذاكرة	الذاكرة الرئيسية
وسائل التحكم في البيئة: مراقب لمعرفة حالة الأجهزة مراقب في سرعة المروحة ITE من "Smart Guardian" وظيفة	IT8728 الأكثر استخدامًا. Super I/O يوفر وظيفة Low Pin Count Interface تدعم تقنية	Super I/O
6.0 / ثنائية/جيجا بايت 3.0 إلى صلت بسرعات البيانات نقل ثنائية/جيجا بايت 3.0 / 2.0 الإصدار SATA مطابقة لمواصفات RAID 0,1,5,10, SRT تدعم تقنية	متكامل Serial ATA متحكم SATA 2 & 3	
تفاوض تلقائي 100/10 ميجا بايت / ثنائية و1 جيجا بايت/ثنائية إمكانية النقل المزدوج الكامل/النصفي	Realtek RTL 8111E	شبكة داخلية
تدعم تقنية الصوت عالي التعريف من 5.1 قنوات لخرج الصوت	ALC662	دعم الصوت عالي التعريف
ثنائية / بايت ميغا 600 إلى تصل بيانات نقل معدلات	H77	USB3.0
	عدد1 قحة PCI Express x16 Gen3 عدد1 قحة PCI Express (x4)x16 Gen2 عدد2 قحة PCI Express Gen2 x 1	قحة القحات قحة
يدعم كل منفذ واحد من أجهزة SATA3	عدد2 منفذ SATA3	منفذ
يدعم كل منفذ واحد من أجهزة SATA2	عدد4 منفذ SATA2	المنفذ على سطح
يدعم تجهيزات اللوحة الأممية	عدد1 منفذ اللوحة الأممية	اللوحة
يدعم وظيفة الصوت باللوحة الأممية	عدد1 منفذ الصوت الأممي	منفذ الصوت الأممي



المواصفات		
توصيل الطاقة لمروحة وحدة المعالجة مع وظيفة Smart Fan	عدد 1	وصلة مروحة وحدة المعالجة المركزية
توصيل الطاقة لمروحة النظام	عدد 1	وصلة مروحة النظام
	عدد 1	وصلة مسح CMOS
يدعم كل منفذ قحتي USB2.0 بالوحة الأممية	عدد 2	منفذ USB2.0
يدعم كل منفذ قحتي USB3.0 بالوحة الأممية	عدد 1	منفذ USB3.0
	عدد 1	منفذ الأحمر تحت مستهلكة
	عدد 1	منفذ طايرة
	عدد 1	منفذ تسلسلي
	عدد 1	منفذ توصيل الطاقة (24بيوس)
	عدد 1	منفذ توصيل الطاقة (4بيبيس)
	عدد 1	لوحة مفاتيح PS/2
	عدد 1	منافذ HDMI
	عدد 1	منافذ VGA
	عدد 1	منافذ DVI
	عدد 1	منفذ دخل/خرج
	عدد 1	الوحة الخلفية
	عدد 2	منافذ USB2.0
	عدد 2	منافذ USB3.0
	عدد 3	مقيس صوت
ATX		حجم اللوحة 220 مم (عرض) X 244 مم (ارتفاع)
يحققها في إضافة أو إزالة الدعم لأي نظام تشغيل بإخطار أو بدون Biostar احتفظ بإخطار .	Windows XP / Vista / 7	دعم أنظمة التشغيل

## JAPANESE

仕様		
CPU	Socket 1155 Intel Core i7 / i5 / i3 / Pentium / Celeron プロセッサ	Execute Disable Bit / Enhanced Intel SpeedStep® / Intel Architecture-64 / Extended Memory 64 Technology / Virtualization Technology / Hyper Threadingをサポートします
チップセット	Intel H77	
メインメモリ	DDR3 DIMMスロット x 4 最大メモリ容量32GB 各DIMMは 512MB/1GB/2GB/4GB/8GB DDR3をサポート	デュアルチャンネルモードDDR3メモリモジュール DDR3 1066 / 1333 をサポート DDR3 1600(CPUに依存) をサポート 登録済みDIMMとECC DIMMはサポートされません
Super I/O	IT8728 もっとも一般に使用されるレガシーSuper I/O機能を採用しています。 低ピンカウントインターフェイス	環境コントロールイニシアチブ、 H/Wモニター ファン速度コントローラ/ モニター ITEの「スマートガーディアン」機能
SATA 2 & 3	統合シリアルATAコントローラ	最高3.0 Gb/秒 / 6.0 Gb/秒のデータ転送速度 SATAバージョン2.0 / 3.0仕様に準拠。 RAID 0,1,5,10, SRTのサポート
LAN	Realtek RTL 8111E	10 / 100 / 1000 Mb/秒のオートネゴシエーション 半/全二重機能
HDオーディオのサポート	ALC662 ハイデフィニションオーディオのサポート 5.1チャンネルオーディオアウト	
USB3.0	H77	データ転送速度最大600 MB / 秒の
スロット	PCI Express Gen3 x16スロット x1 PCI Express Gen2 x16スロット x1 PCI Express Gen2 x 1スロット x2	
オンボードコネクタ	SATA3コネクタ x2 SATA2コネクタ x4 フロントパネルコネクタ x1 フロントオーディオコネクタ x1 CPUファンヘッダ x1	各コネクタは1つのSATA3デバイスをサポートします 各コネクタは1つのSATA2デバイスをサポートします フロントパネル機能をサポートします フロントパネルオーディオ機能をサポートします CPUファン電源装置(スマートファン機能を搭載)

仕様			
	システムファンヘッダ	x1	システムファン電源装置
	CMOSクリアヘッダ	x1	
	USB2.0コネクタ	x2	各コネクタは2つのフロントパネルUSB2.0ポートをサポートします
	USB3.0コネクタ	x1	各コネクタは2つのフロントパネルUSB3.0ポートをサポートします
	消費者IRコネクタ	x1	
	プリンタポートコネクタ	x1	各コネクタは1つのプリンタポートをサポートします
	シリアルポート	x1	
	電源コネクタ(24ピン)	x1	
	電源コネクタ(4ピン)	x1	
背面パネル I/O	PS/2キーボード	x1	
	HDMIポート	x1	
	VGAポート	x1	
	DVI-Dポート	x1	
	LANポート	x1	
	USB2.0ポート	x2	
	USB3.0ポート	x2	
	オーディオジャック	x3	
ボードサイズ	220 mm (幅) X 244 mm (高さ)		ATX
OSサポート	Windows XP / Vista / 7		Biostarは事前のサポートなしにOSサポートを追加または削除する権利を留保します。

2012/04/10