

FCC Information and Copyright

This equipment has been tested and found to comply with the limits of a Class B digital device, pursuant to Part 15 of the FCC Rules. These limits are designed to provide reasonable protection against harmful interference in a residential installation. This equipment generates, uses and can radiate radio frequency energy and, if not installed and used in accordance with the instructions, may cause harmful interference to radio communications. There is no guarantee that interference will not occur in a particular installation.

The vendor makes no representations or warranties with respect to the contents here and specially disclaims any implied warranties of merchantability or fitness for any purpose. Further the vendor reserves the right to revise this publication and to make changes to the contents here without obligation to notify any party beforehand.

Duplication of this publication, in part or in whole, is not allowed without first obtaining the vendor's approval in writing.

The content of this user's manual is subject to be changed without notice and we will not be responsible for any mistakes found in this user's manual. All the brand and product names are trademarks of their respective companies.

PACKAGE CHECKLIST

- * FDD Cable x 1
- * HDD Cable x 1
- * User's Manual x 1
- * Serial ATA Cable x 1
- * Serial ATA Power Cable x 1
- * Fully Setup Driver CD x 1
- * Rear I/O Panel for ATX Case x 1
- * SPDIF Cable x 1 (optional)
- * USB 2.0 Cable x 1 (optional)
- * IEEE1394A Cable x 1 (optional)

Table of Contents

PACKAGE CHECKLIST.....	1
CHAPTER 1: INTRODUCTION.....	1
1.1 MOTHERBOARD FEATURES.....	1
1.2 LAYOUT AND COMPONENTS.....	3
CHAPTER 2: HARDWARE INSTALLATION.....	4
2.1 INSTALLING CENTRAL PROCESSING UNIT (CPU).....	4
2.2 SYSTEM MEMORY.....	6
2.3 PERIPHERALS.....	8
CHAPTER 3: NVIDIA RAID FUNCTIONS.....	19
3.1 OPERATION SYSTEM.....	19
3.2 RAID ARRAYS.....	19
3.3 HOW RAID WORKS.....	20
CHAPTER 4: OVERCLOCK QUICK GUIDE.....	23
4.1: T-POWER INTRODUCTION.....	23
4.2: T-POWER BIOS FEATURE.....	24
4.3 T-POWER WINDOWS FEATURE.....	32
CHAPTER 5: USEFUL HELP.....	41
5.1 DRIVER INSTALLATION NOTE.....	41
5.2 AWARD BIOS BEEP CODE.....	42
5.3 EXTRA INFORMATION.....	43
5.4 TROUBLESHOOTING.....	45
GERMAN.....	46
FRENCH.....	48
ITALIAN.....	50
SPANISH.....	52
PORTUGUESE.....	54
POLAND.....	56
RUSSIAN.....	58
ARABIC.....	60
JAPANESE.....	62

CHAPTER 1: INTRODUCTION

1.1 MOTHERBOARD FEATURES

CPU

- Supports Socket 939.
- Supports AMD Athlon 64 FX / Athlon 64 /Athlon 64 X2 processors.
- Supports AMD Sempron processor.
- AMD 64 architecture enables simultaneous 32 and 64 bit computing.
- Supports HyperTransport and AMD Cool'n'Quiet Technology.

Chipset

- NVIDIA nForce4 for TForce4
- NVIDIA nForce4 Ultra for TForce4 Ultra.
- Both support:
 - Supports NVIDIA Firewall.
 - Supports Gigabit Ethernet.
 - Supports NVIDIA nTune Utility.
 - Supports NVIDIA Secure Networking Processor.

Operating Systems

- Supports Windows 2000 and Windows XP.
Note: Does not support Windows 98SE and Windows ME.

Dimensions

- ATX Form Factor: 23.4cm (W) x 29.35cm (L)

Main Memory

- Supports Dual Channel DDR.
- Supports DDR333 and DDR400.
- Maximum memory space is 4GB, supporting 4 DIMM sockets.

Serial ATA

- nForce4 Ultra supports SATA 2.0 specification, with data transfer rates up to 3Gb/s.
- nForce4 supports SATA 1.0 specification, with data transfer rates up to 1.5Gb/s.

Super I/O

- Chip: ITE IT8712F.
- Environment Control initiatives
 - H/W Monitor
 - Fan Speed Controller
 - ITE's "Smart Guardian" function

IDE

- 2 on-board connectors support 4 IDE disk drives.
- Supports PIO mode 0-4, Block Mode and Ultra DMA 33/66/100/133 bus master mode.

AC'97 Audio Sound Codec

- Chip: ALC850, supports 8 channels audio output.

IEEE 1394A Chip

- Chip: VIA VT6307, supports 2 ports with transfer up to 400Mb/s.

Gigabit Ethernet LAN

- NVIDIA Gigabit MAC + VITESSE Gigabit PHY VSC8201.
- Supports ACPI power management.
- Supports NVIDIA StreamThru technology
 - Isochronous controller paired with Hyper Transport results in fastest networking performance.

Security

- NVIDIA Firewall technology
 - Native firewall solution protects the PC from intruders by filtering unauthorized traffic.
- NVIDIA Active Armor (Only for nForce4 Ultra)
 - Enhances network security, and provides users with an environment both fast and secure.

NVIDIA RAID Technology

- RAID 0 disk striping for highest system and application performance
- RAID 1 disk mirroring support for fault tolerance
Support for both SATA and ATA-133 disk controller standards
- RAID 0+1 disk striping and mirroring for highest performance with fault tolerance.

Internal On-board Slots and Connectors

- One PCI-Express X16 slot.
- One Xtreme Graphics slot.
- One SPDIF-Out connector.
- One CD-ROM audio-in connector.
- Two PCI-Express X1 slots.
- Two Ultra DMA 133/100/66/33 IDE connectors.
- Three PCI slots.
- Four SATA ports.

Back Panel I/O Connectors and Ports

- 1 Printer Port.
- 1 RJ-45 LAN jack.
- 1 PS/2 Mouse Port.
- 1 PS/2 Keyboard Port.
- 1 1394A Firewire Port.
- 1 Serial Port. (COM2 is optional.)
- 4 USB 2.0 Ports.
- 6 audio ports support 8 channels audio-out facilities.

1.2 LAYOUT AND COMPONENTS

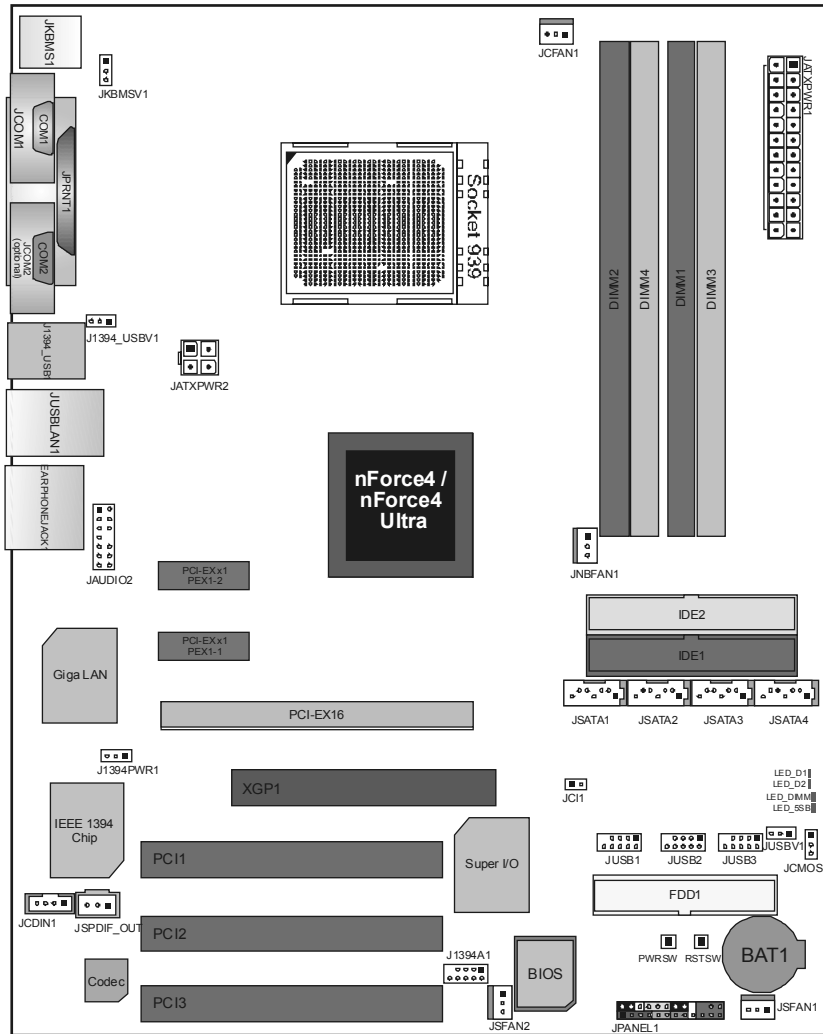

Note: ■ represents the 1st pin.

CHAPTER 2: HARDWARE INSTALLATION

2.1 INSTALLING CENTRAL PROCESSING UNIT (CPU)

A. Central Processing Unit (CPU)

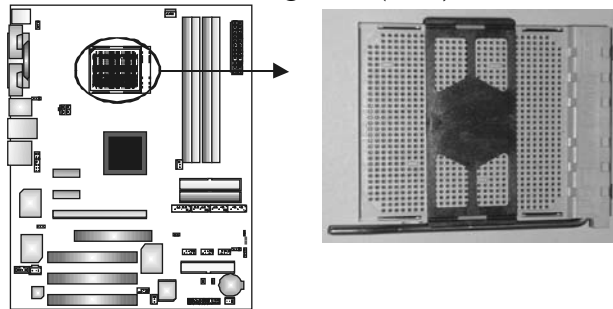

Step 1: Remove the socket protection cap.

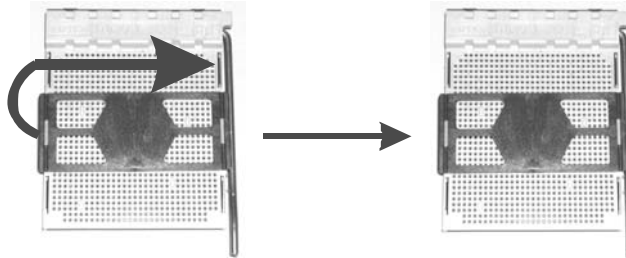

Step 2: Pull the lever toward direction A from the socket and then raise the lever up to a 90-degree angle.

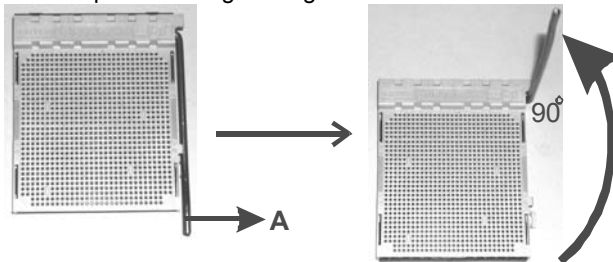

Step 3: Look for the white triangle on socket, and the gold triangle on CPU should point forwards this white triangle. The CPU will fit only in the correct orientation.

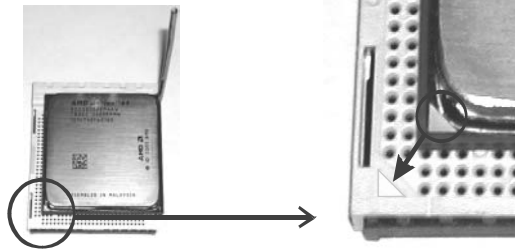

Step 4: Hold the CPU down firmly, and then close the lever toward direct B to complete the installation.

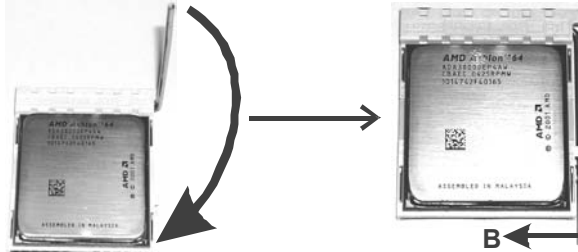

Step 5: Put the CPU Fan on the CPU and buckle it. Connect the CPU FAN power cable to the JCFAN1. This completes the installation.

B. About FAN Headers

CPU FAN Power Header: JCFAN1

System Fan Power Headers: JSFAN1/ JSFAN2

North Bridge Fan Power Header: JNBFAN1

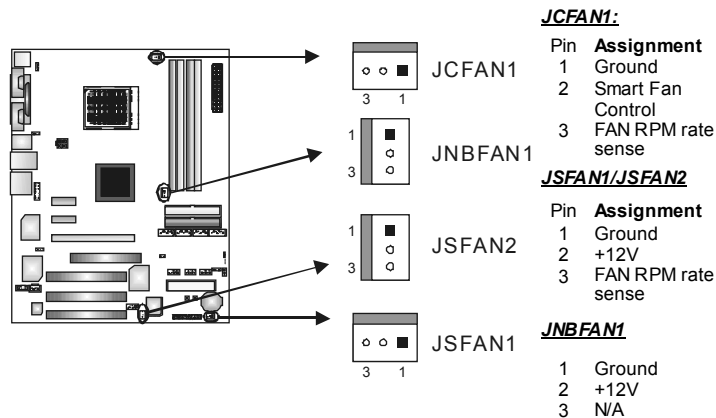

Note:
 JCFAN1、JSFAN1/JSFAN2 and JNBFAN1 reserve system cooling fan with Smart Fan Control utilities. It supports 3 pin head connector. When connecting with wires onto connectors, please note that the red wire is the positive and should be connected to pin#2, and the black wire is Ground and should be connected to GND.

2.2 SYSTEM MEMORY

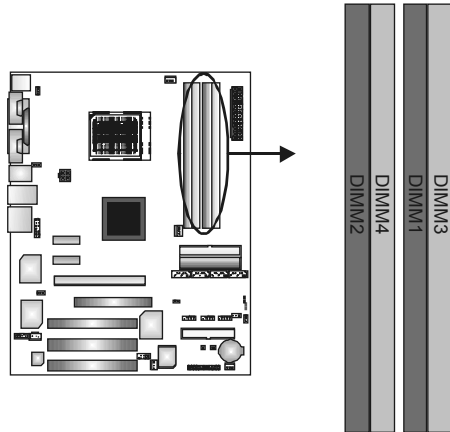

A. Memory Modules

1. Unlock a DIMM slot by pressing the retaining clips outward. Align a DIMM on the slot such that the notch on the DIMM matches the break on the slot.

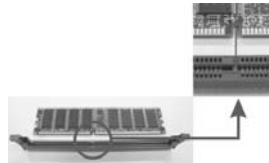

2. Insert the DIMM vertically and firmly into the slot until the retaining chip snaps back in place and the DIMM is properly seated.

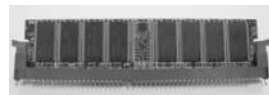

Notes:
 To remove the DDR modules, push the ejector tabs at both sides of the slot outward at the same time, and pull the modules out vertically.

B. Memory Capacity

DIMM Socket Location	DDR Module	Total Memory Size
DIMM1	128MB/256MB/512MB/1GB *1	Max is 4 GB.
DIMM2	128MB/256MB/512MB/1GB *1	
DIMM3	128MB/256MB/512MB/1GB *1	
DIMM4	128MB/256MB/512MB/1GB *1	

C. DDR Installation Notice

- For AMD K8 939 CPU launched before Rev. E, please follow the table below to install your DDR memory module, or the system may not boot up or may not function properly. (Please refer to Table 1 for CPU Revision)
- “SS” represents Single Side DDR memory module.
- “DS” represents Double Side DDR memory module.
- Star sign “*” represents leave the DIMM socket empty.

DIMM1	SS/DS	*	SS/DS	*	SS/DS
DIMM2	*	*	SS/DS	*	SS/DS
DIMM3	*	SS/DS	*	SS/DS	SS/DS
DIMM4	*	*	*	SS/DS	SS/DS

D. Know your CPU version

AMD Athlon™ 64 Processor Ordering Part Number Example
 ADA 3200 A E P 5 AP



Table 1: AMD Athlon™ 64 Processor Part Definition

Part Definition	Revision	Part Definition	Revision
AP	Rev C0	BN	Rev E4
AR	Rev CG	BP	Rev E3
AS	Rev CG	BO	Rev E3
AW	Rev CG	BY	Rev E6
AX	Rev CG	BW	Rev E6
AZ	Rev CG		
BI	Rev D0		

2.3 PERIPHERALS

A. Card and I/O Slots:

Floppy Disk Connector: FDD1

The motherboard provides a standard floppy disk connector that supports 360K, 720K, 1.2M, 1.44M and 2.88M floppy disk types. This connector supports the provided floppy drive ribbon cables.

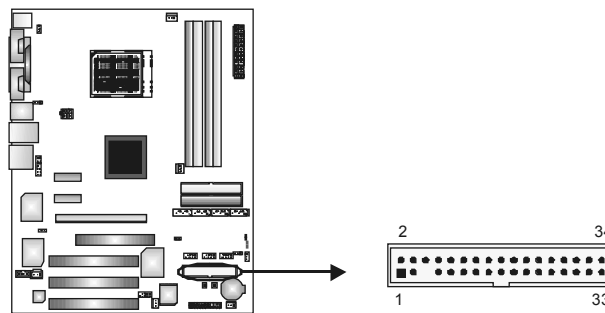

Hard Disk Connectors: IDE1/IDE2

The motherboard has two 32-bit Enhanced PCI IDE Controllers that provide PIO Mode 0~5, Bus Master, and Ultra DMA 33/66/100/133 functionality. It has two HDD connectors IDE1 (primary) and IDE2 (secondary). The IDE connectors can connect a master and a slave drive, so you can connect up to four hard disk drives. The first hard drive should always be connected to IDE1.

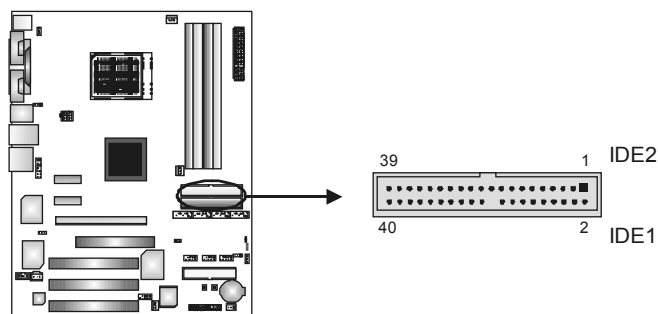

Peripheral Component Interconnect Slots: PCI1~PCI3

This motherboard is equipped with 3 standard PCI slots. PCI stands for Peripheral Component Interconnect, and it is a bus standard for expansion cards. This PCI slot is designated as 32 bits.

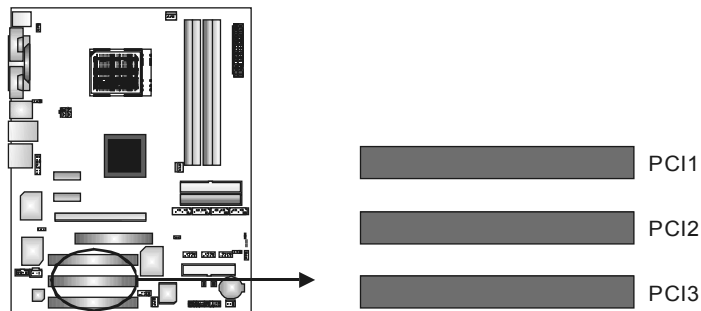

PCI-Express Slots: PCI-EX16/ PEX1_2/ PEX1_1

PCI-EX16:

PCI Express 1.0a compliant.
Maximum bandwidth is up to 4GB/s per direction.

PEX1_2/ PEX1_1:

PCI Express 1.0a compliant.
Maximum bandwidth is up to 250MB/s per direction.

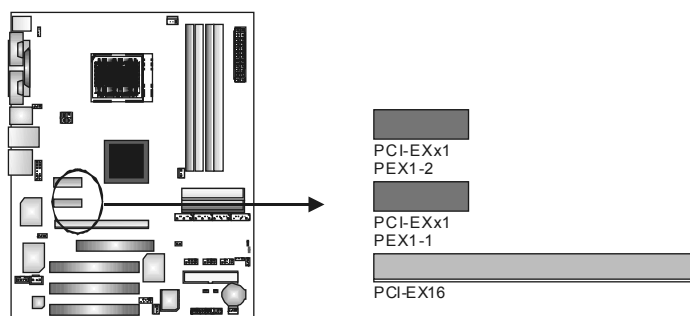

Xtreme Graphics Port Slot: XGP1

This XGP (Extreme Graphics Port) slot is a special design that only supports compatible AGP VGA cards.

To install the system with an add-on AGP VGA card, please make sure to install the driver of add-on AGP VGA card before onboard VGA driver installation. If the onboard VGA driver has already been installed before you install the add-on AGP VGA card, the system will automatically set the onboard VGA as the primary graphics adapter.

For the onboard VGA driver can't be removed completely, and to solve this problem, please follow the steps below,

Disable onboard VGA utility under the operating system, and reboot PC. After PC restarts, the system will automatically set the AGP VGA card as the graphics adapter.

Or, re-install your operating system to ensure the AGP VGA card function can be used.

Note:

Please go to "<http://www.biostar.com.tw>" for more detailed information about XGP compatible AGP cards.

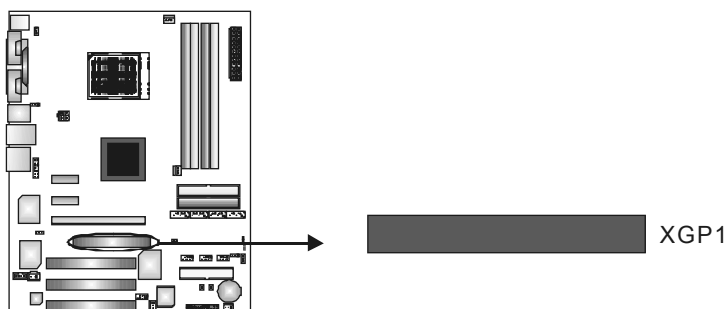

B. Connectors and Headers:

How to setup Jumpers

The illustration shows how to set up jumpers. When the jumper cap is placed on pins, the jumper is “closed”, if not, that means the jumper is “open”.



Pin opened



Pin closed



Pin1-2 closed

ATX Power Source Connector: JATXPWR1

JATXPWR1 allows user to connect 24-pin power connector on the ATX power supply.

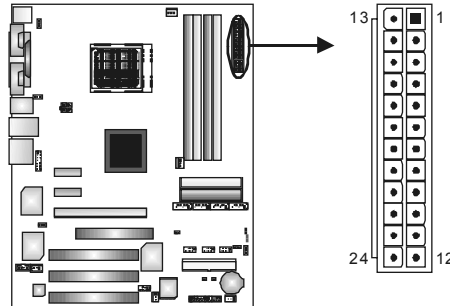

Pin	Assignment	Pin	Assignment
13	+3.3V	1	+3.3V
14	-12V	2	+3.3V
15	Ground	3	Ground
16	PS_ON	4	+5V
17	Ground	5	Ground
18	Ground	6	+5V
19	Ground	7	Ground
20	NC	8	PW_OK
21	+5V	9	Standby Voltage+5V
22	+5V	10	+12V
23	+5V	11	+12V
24	Ground	12	+3.3V

ATX Power Source Connector: JATXPWR2

By connecting JATXPWR2, it will provide +12V to CPU power circuit.

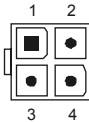
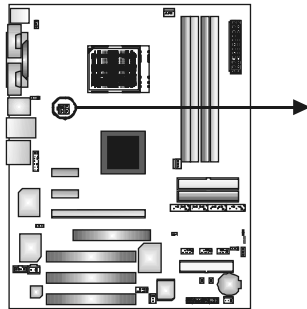

Pin	Assignment
1	+12V
2	+12V
3	Ground
4	Ground

Power Source Header for PS/2 Keyboard/Mouse: JKBMSV1

Pin 1-2 Close: +5V for PS/2 keyboard and mouse.
(Factory default setting)

Pin 2-3 Close: PS/2 keyboard and mouse are powered with +5V standby voltage.

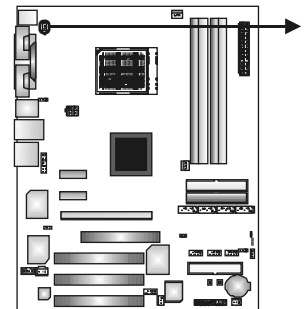

Pin 1-2 close
(Default)



Pin 2-3 close

Note: In order to support this function "Power-on system via keyboard and mouse," JKBMSV1 jumper cap should be placed on Pin 2-3.

Front Panel Audio-out Header: JAUDIO2

This connector will allow user to connect with the front audio output headers on the PC case. It will disable the output on back panel audio connectors.

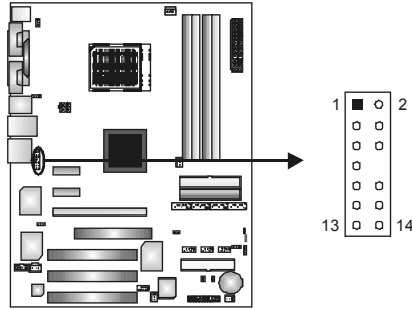

Pin	Assignment	Pin	Assignment
1	Mic in/center	2	Ground
3	Mic power/Bass	4	Audio power
5	Right line out/ Speaker out Right	6	Right line out/ Speaker out Right
7	Reserved	8	Key
9	Left line out/ Speaker out Left	10	Left line out/ Speaker out Left
11	Right line in/ Rear speaker Right	12	Right line in/ Rear speaker Right
13	Left line in/ Rear speaker Left	14	Left line in/ Rear speaker Left

CD-ROM Audio-in Connector: JCDIN1

This connector allows user to connect the audio source from a variety of devices, like CD-ROM, DVD-ROM, PCI sound card, PCI TV tuner card etc.

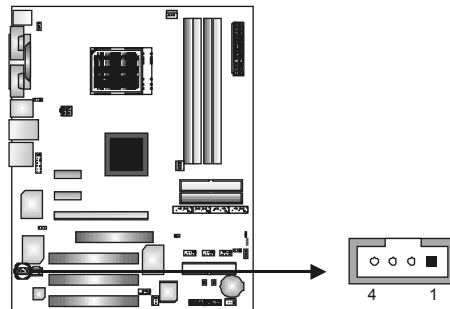

Pin	Assignment
1	Left channel input
2	Ground
3	Ground
4	Right channel input

Headers for USB Ports at Front Panel: JUSB1~JUSB3

This connector allows user to connect additional USB cables at PC front panel, and also can be connected with internal USB devices, like USB card reader.

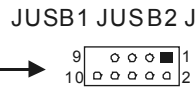
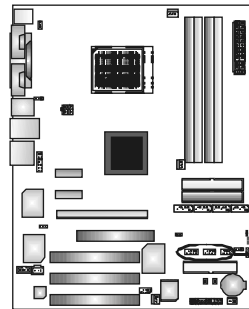

Pin	Assignment
1	+5V (fused)
2	+5V (fused)
3	USB-
4	USB-
5	USB+
6	USB+
7	Ground
8	Ground
9	Key
10	NC

Power Source Headers for USB Ports: J1394_USBV1/JUSBV1

Pin 1-2 Close:

J1394_USBV1: +5V for USB ports at J1394_USB1 and JUSBLAN1.
 JUSBV1: +5V for front USB headers (JUSB1/JUSB2/JUSB3).

Pin 2-3 Close:

J1394_USBV1: USB ports at J1394_USB1 and JUSBLAN1 are powered with +5V standby voltage.
 JUSBV1: Front USB headers (JUSB1/JUSB2/JUSB3) are powered with +5V standby voltage.

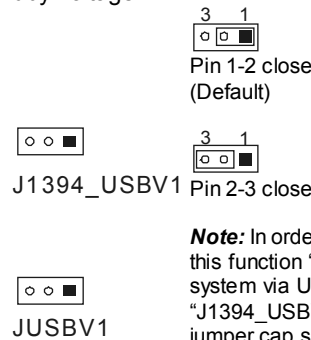
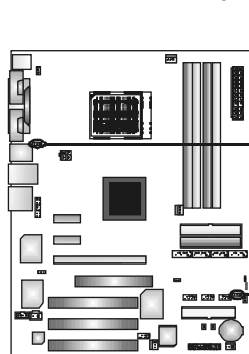

Note: In order to support this function "Power-on system via USB device," "J1394_USBV1/JUSBV1" jumper cap should be placed on Pin 2-3 individually.

Digital Audio-out Connector: JSPDIF_OUT

This connector allows users to connect the PCI bracket SPDIF output header.

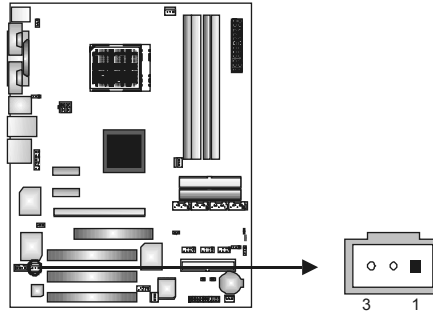

Pin Assignment

- 1 +5V
- 2 SPDIF OUT
- 3 Ground

Serial ATA Connectors: JSATA1~JSATA4

The motherboard has an SATA Controller in nForce4 CK8-04 and CK8-04 Ultra with 4 channels SATA interface, it satisfies the SATA 1.0 with transfer rate of 1.5 Gb/s and SATA 2.0 spec with transfer rate of 3.0 Gb/s.

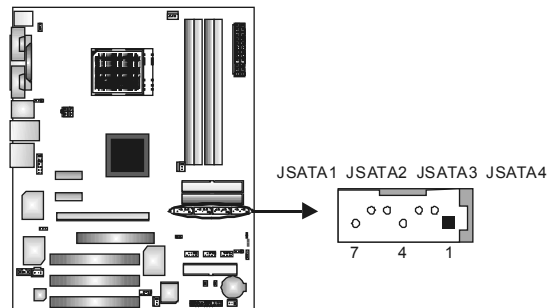

Pin Assignment

- 1 Ground
- 2 TX+
- 3 TX-
- 4 Ground
- 5 RX-
- 6 RX+
- 7 Ground

Case Open Header: JCI1

This connector allows system to monitor PC case open status. If the signal has been triggered, it will record to the CMOS and show the message on next boot-up.

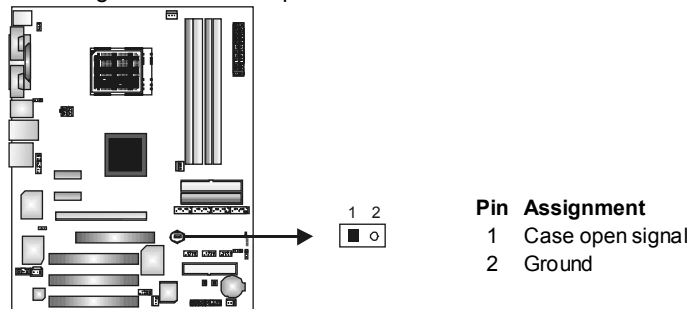
**Clear CMOS Header: JCMOS1**

By placing the jumper on pin 2-3, it allows user to restore the BIOS safe setting and the CMOS data, please carefully follow the procedures to avoid damaging the motherboard.

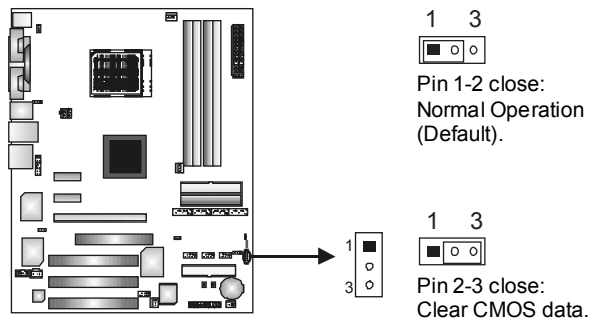
**※ Clear CMOS Procedures:**

1. Remove AC power line.
2. Set the jumper to "Pin 2-3 close".
3. Wait for five seconds.
4. Set the jumper to "Pin 1-2 close".
5. Power on the AC.
6. Reset your desired password or clear the CMOS data.

J1394A1: Header for 1394 Firewire Port at Front Panel

This header allows user to connect the digital image device, like DV, D8, or V8, etc.

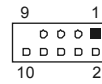
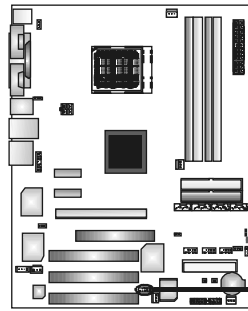

Pin Assignment

- 1 A+
- 2 A-
- 3 Ground
- 4 Ground
- 5 B+
- 6 B-
- 7 +12V
- 8 +12V
- 9 Key
- 10 Ground

J1394PWR1: Power Source for 1394 Firewire Port

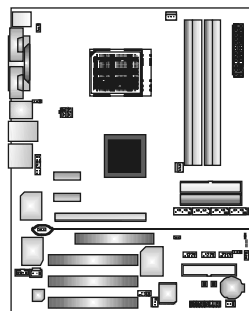

Pin 1-2 close
+3.3V for 1394 chipset (Default).



Pin 2-3 close
+3.3V SB for 1394 chipset.

On-Board LED Indicators

There are 2 LED indicators on the motherboard to show system status.

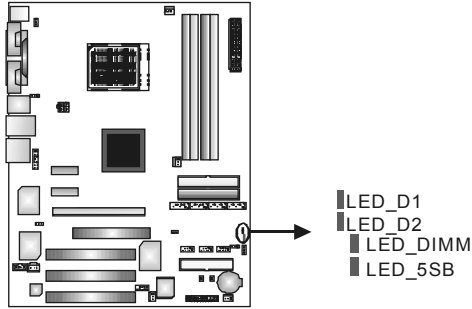

LED_D1 and LED_D2:

These 2 LED indicate system power on diagnostics. Please refer to the table below for different messages:

LED_D1	LED_D2	Message
ON	ON	Normal
ON	OFF	Memory Error
OFF	ON	VGA Error
OFF	OFF	Abnormal: CPU / Chipset error.

LED_DIMM:

This LED indicates the voltage of memory is activated normally.

LED_5SB:

This LED indicates the system is ready for Power-on.

On-Board Buttons

There are 2 on-board buttons.

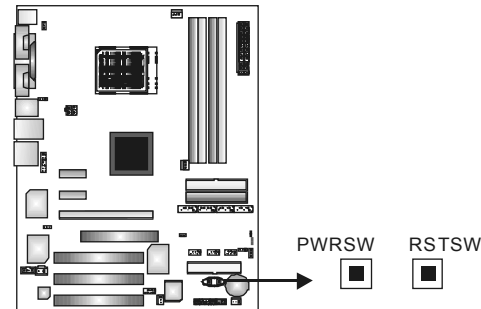

PWRSW:

This is an on-board Power Switch button.

RSTSW:

This is an on-board Reset button.

CHAPTER 3: NVIDIA RAID FUNCTIONS

3.1 OPERATION SYSTEM

Supports Windows XP Home/Professional Edition, and Windows 2000 Professional.

3.2 RAID ARRAYS

NVRAID supports the following types of RAID arrays:

RAID 0: RAID 0 defines a disk striping scheme that improves disk read and write times for many applications.

RAID 1: RAID 1 defines techniques for mirroring data.

RAID 0+1: RAID 0+1 combines the techniques used in RAID 0 and RAID 1.

Spanning (JBOD): JBOD provides a method for combining drives of different sizes in to one large disk.

3.3 HOW RAID WORKS

RAID 0:

The controller “stripes” data across multiple drives in a RAID 0 array system. It breaks up a large file into smaller blocks and performs disk reads and writes across multiple drives in parallel. The size of each block is determined by the stripe size parameter, which you set during the creation of the RAID set based on the system environment. This technique reduces overall disk access time and offers high bandwidth.

Features and Benefits

- **Drives:** Minimum 1, and maximum is up to 6 or 8. Depending on the platform.
- **Uses:** Intended for non-critical data requiring high data throughput, or any environment that does not require fault tolerance.
- **Benefits:** provides increased data throughput, especially for large files. No capacity loss penalty for parity.
- **Drawbacks:** Does not deliver any fault tolerance. If any drive in the array fails, all data is lost.
- **Fault Tolerance:** No.

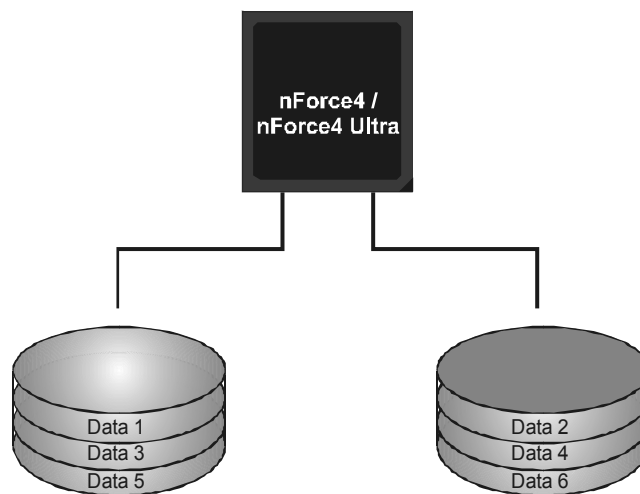

RAID 1:

Every read and write is actually carried out in parallel across 2 disk drives in a RAID 1 array system. The mirrored (backup) copy of the data can reside on the same disk or on a second redundant drive in the array. RAID 1 provides a hot-standby copy of data if the active volume or drive is corrupted or becomes unavailable because of a hardware failure. RAID techniques can be applied for high-availability solutions, or as a form of automatic backup that eliminates tedious manual backups to more expensive and less reliable media.

Features and Benefits

- **Drives:** Minimum 2, and maximum is 2.
- **Uses:** RAID 1 is ideal for small databases or any other application that requires fault tolerance and minimal capacity.
- **Benefits:** Provides 100% data redundancy. Should one drive fail, the controller switches to the other drive.
- **Drawbacks:** Requires 2 drives for the storage space of one drive. Performance is impaired during drive rebuilds.
- **Fault Tolerance:** Yes.

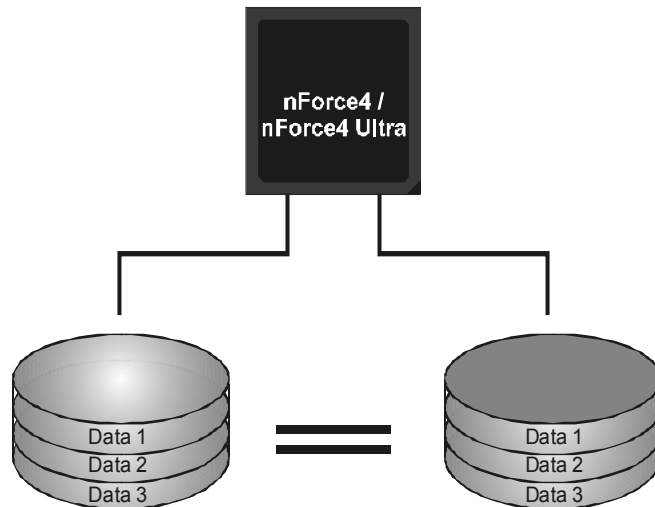

RAID 0+1:

RAID 0 drives can be mirrored using RAID 1 techniques. Resulting in a RAID 0+1 solution for improved performance plus resiliency.

Features and Benefits

- **Drives:** Minimum 4, and maximum is 6 or 8, depending on the platform.
- **Benefits:** Optimizes for both fault tolerance and performance, allowing for automatic redundancy. May be simultaneously used with other RAID levels in an array, and allows for spare disks.
- **Drawbacks:** Requires twice the available disk space for data redundancy, the same as RAID level 1.
- **Fault Tolerance:** Yes.

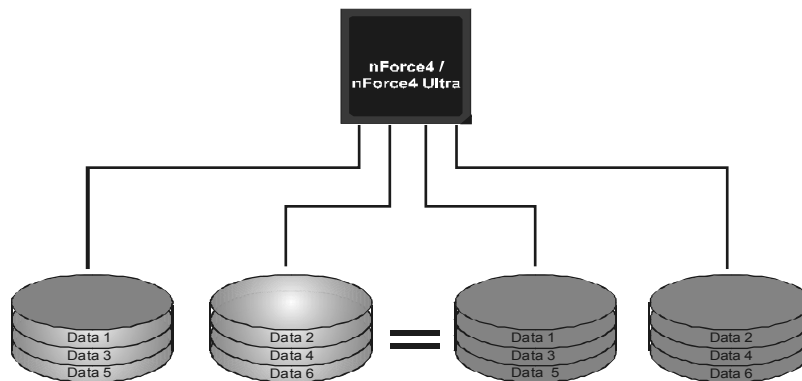

※ For more detailed setup information, please refer to the Driver CD, or go to http://www.nvidia.com/page/pg_20011106217193.html to download NVIDIA nForce Tutorial Flash.

CHAPTER 4: OVERCLOCK QUICK GUIDE

4.1: T-POWER INTRODUCTION

Biostar T-Power is a whole new utility that is designed for overclock users.

Based on many precise tests, *Biostar Engineering Team* (BET) has developed this ultimate overclock engine to raise system performance.

No matter whether under BIOS or Windows interface, *T-Power* is able to present the best system state according to users' overclock setting.

T-Power BIOS Features:

- Overclocking Navigator Engine (O.N.E.)
- CMOS Reloading Program (C.R.P.)
- Memory Integration Test (M.I.T., under Overclock Navigator Engine)
- Integrated Flash Program (I.F.P.)
- Smart Fan Function (under PC Health Status)
- Self Recovery System (S.R.S)

T-Power Windows Feature:

- Hardware Monitor
- Overclock Engine
- Smart Fan Function
- Life Update

4.2: T-POWER BIOS FEATURE

A. Overclocking Navigator Engine (O.N.E.):

ONE provides two powerful overclocking engines: MOS and AOS for both Elite and Casual overclockers.

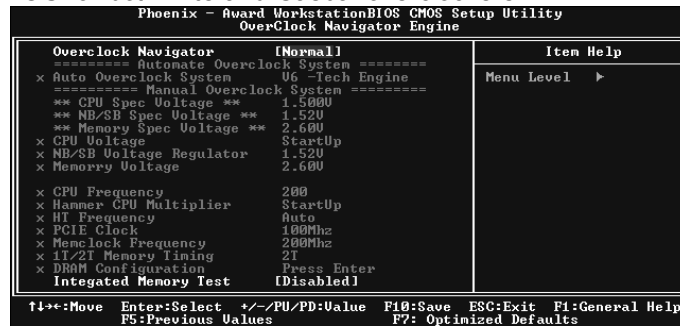

Manual Overclock System (M.O.S.)

MOS is designed for experienced overclock users.

It allows users to customize personal overclock settings.



CPU Overclock Setting:**CPU Voltage:**

This function will increase CPU stability when overclocking. However, the CPU temperature will increase when CPU voltage is increased.

Choices: The range is from 1.2V to 1.725V, with an interval of 0.0.25V.

CPU Frequency:

CPU Frequency is directly in proportion to system performance. To maintain the system stability, CPU voltage needs to be increased also when raising CPU frequency.

Choices: This range is from 200 to 450, with an interval of 1MHz.

Hammer CPU Multiplier:

The MOS allows users to downgrade the CPU ratio when overclocking.

Choices: The lower limit is x4 (800MHz). The upper limit is decided by different CPU type. With an x1 (200MHz) interval.

Memory Overclock Setting:**Memory Voltage:**

This function will increase memory stability when overclocking.

Choices: The range is from 2.6V to 2.9V, with an interval of 0.1V.

Memclock Frequency:

To get better system performance, sometimes downgrading the memory frequency is necessary when CPU frequency is adjusted over the upper limit.

Choices: 100, 133, 166, 200, 216, 233, 250 (MHz).

PCI-Express Overclock Setting:**PCI-E Clock:**

It helps to increase VGA card performance.

Choices: The range is from 100 to 145, with an interval of 1MHz.

Chipset Overclock Setting:**NB/SB Voltage Regulator:**

This function will increase chipset stability when overclocking.

Choices: 1.52V, 1.60V, 1.68V, 1.76V.

HT Frequency:

We recommend users to set this item at "x4" when overclocking.

Choices: x1, x2, x3, x4, x5, Auto.

Notice: According to tests that have been done; AMD Athlon XP 3000+ CPU is the best CPU type for overclock function.

Automatic Overclock System (A.O.S.)

For beginners in overclock field, BET had developed an easy, fast, and powerful feature to increase the system performance, named A.O.S.

Based on many tests and experiments, A.O.S. provides 3 ideal overclock configurations that are able to raise the system performance in a single step.



V6 Tech Engine:

This setting will raise about 10%~15% of whole system performance.



V8 Tech Engine:

This setting will raise about 15%~25% of whole system performance.

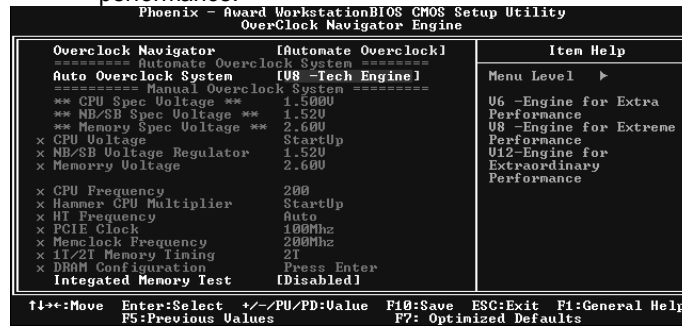

V12 Tech Engine:

This setting will raise about 25%~30% of whole system performance.



Notices:

1. Not all types of AMD CPU perform above overclock setting ideally; the difference will be based on the selected CPU model.
2. From BET experiments, the Atholon64 FX CPU is not suitable for this A.O.S. feature.

B. CMOS Reloading Program (C.R.P.):

It allows users to save different CMOS settings into BIOS-ROM. Users are able to reload any saved CMOS setting for customizing system configurations. Moreover, users are able to save an ideal overclock setting during overclock operation. There are 50 sets of record addresses in total, and users are able to name the CMOS data according to personal preference.

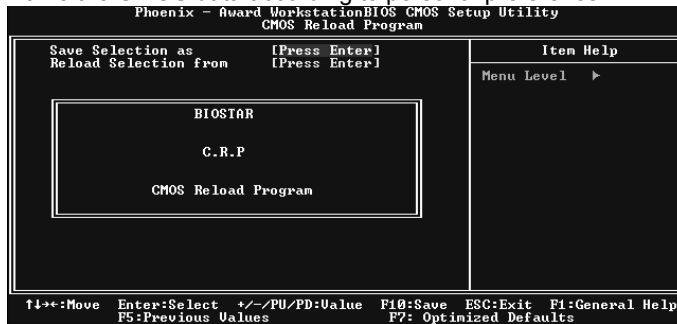

C. Memory Integration Test (M.I.T.):

This function is under “Overclocking Navigator Engine” item. MIT allows users to test memory compatibilities, and no extra devices or software are needed.

Step 1:

The default setting under this item is “Disabled”; the condition parameter should be changed to “Enable” to proceed this test.

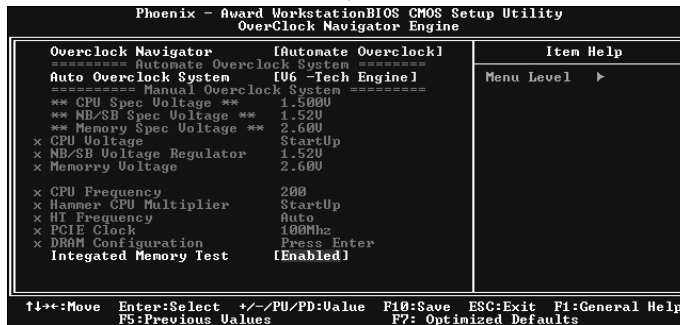
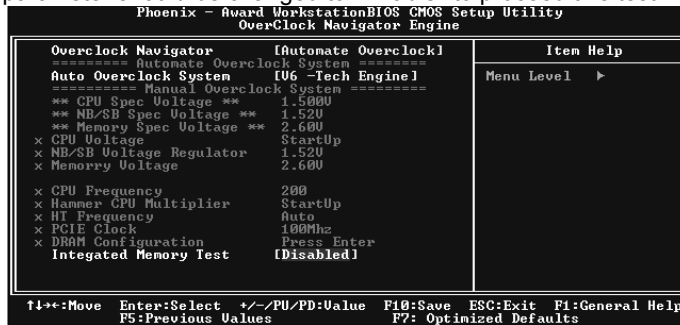

Step 2:

Save and Exit from CMOS setup and reboot the system to activate this test.

Run this test for 5 minutes (minimum) to ensure the memory stability.

Step 3:

When the process is done, change the setting back from “Enable” to “Disable” to complete the test.

D. Self Recovery System (S.R.S.):

This function can't be seen under T-Power BIOS setup; and is always on whenever the system starts up.

However, it can prevent system hang-up due to inappropriate overclock actions.

When the system hangs up, S.R.S. will automatically log in the default BIOS setting, and all overclock settings will be re-configured.

E. Integrated Flash Program (I.F.P.):

IFP is a safe and quick way to upgrade BIOS.

By pressing "Enter" key three times, and the upgrading process will be completed easily.

F. Smart Fan Function:

Smart Fan Function is under "PC Health Status".

This is a brilliant feature to control CPU Temperature vs. Fan speed.

When enabling Smart Fan function, Fan speed is controlled automatically by CPU temperature.

This function will protect CPU from overheat problem and maintain the system temperature at a safe level.

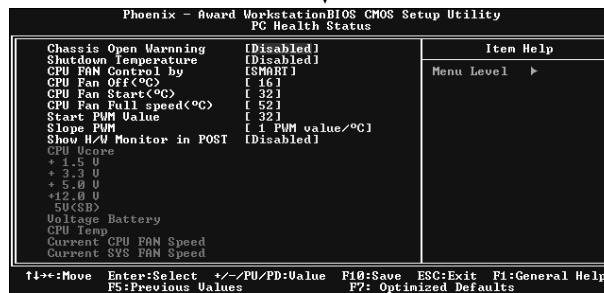
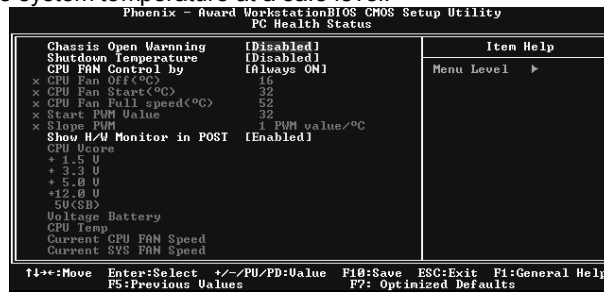

CPU Fan Off $^{\circ}\text{C}$:

If the CPU temperature is lower than the set value, the CPU fan will turn off. The range is from 0°C ~ 127°C , with an interval of 1°C .

Choices: 16°C (default).

CPU Fan Start <°C>

The CPU fan starts to work when CPU temperature arrives to this set value. The range is from 0°C~127°C, with an interval of 1°C.

Choices: 32°C (default).

CPU Fan Full speed <°C>

When CPU temperature arrives to the set value, the CPU fan will work under Full Speed. The range is from 0°C~127°C, with an interval of 1°C.

Choices: 52°C (default).

Start PWM Value

When CPU temperature arrives to the set value, the CPU fan will work under Smart Fan Function mode. The range is from 0~127, with an interval of 1.

Choices: 32 (default).

Slope PWM

Choices: 1 PWM Value/°C (default), 2 PWM Value/°C, 4 PWM Value/°C, 8 PWM Value/°C, 16 PWM Value/°C, 32 PWM Value/°C, 64PWM Value/°C.

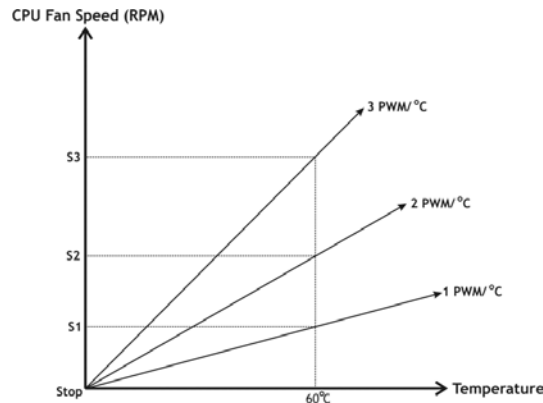

S1: CPU temperature is 60°C, and PWM value is 1 PWM/°C.

S2: CPU temperature is 60°C, and PWM value is 2 PWM/°C.

S3: CPU temperature is 60°C, and PWM value is 3 PWM/°C.

Increasing the value of slope PWM will raise the speed of CPU fan.

As in above diagram, when the CPU temperature reaches 60°C, the CPU fan speed for 3 PWM/°C is higher than 1 PWM/°C (S1<S2<S3).

4.3 T-POWER WINDOWS FEATURE

A. Hardware Monitor:

T-Power Hardware monitor allows users to monitor system voltage, temperature and fan speed accordingly. Additionally, a rescue action will be taken by the program automatically while the system faces an abnormal condition. The program will trigger an alarm or shut down the system when unpredictable errors occur. All the monitoring items are illustrated by a waveform diagram.

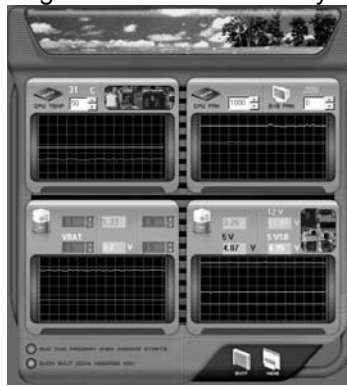

Hardware Monitor Toolbar



i. Start-up Setting

Click on this item to run Hardware Monitor Program when the Windows starts-up.

ii. Dialogue-Box Setting

Click on this item to pop-up warning dialogue-box when PC system is abnormal.

iii. Exit

Click on this item to exit Hardware Monitor Program.

iv. Hide

Click on this item to hide this program in system tray. When hiding the program, there will be a check icon in the system tray.



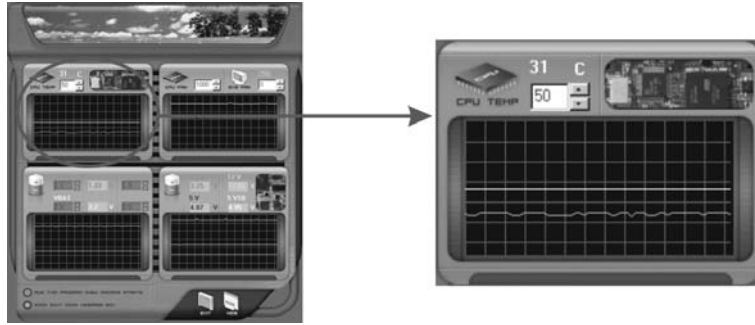

CPU Temperature

This column configures the CPU temperature. There is a waveform to represent the status of CPU temperature.





By adjusting , users can easily configure the upper limit of CPU temperature for system operating.

In this diagram, the white line represents the upper limit which user-set for CPU temperature and the green line shows present CPU temperature.

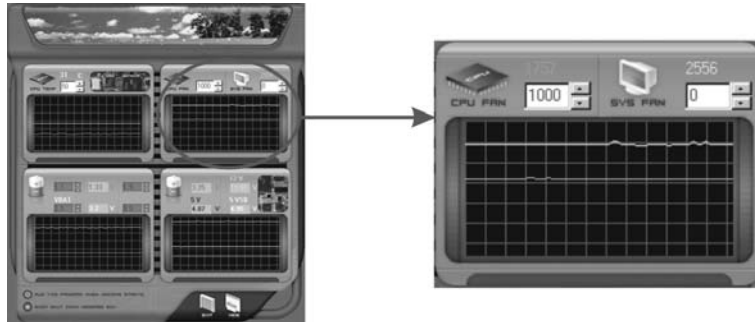

If the CPU temperature is higher than the upper limit, the status line color will change from green to red, and a warning sound will alert you. Also, the system tray icon  would change to .

FAN Speed



By adjusting , users can easily configure the lower limit of the fan speed.

In this diagram, the green line shows present CPU Fan speed, and the yellow line shows System Fan speed (if any).

If any one of the fans speeds is lower than the set value, the status line will change into a red warning line, and the program will trigger an alarm system automatically. Also, the system tray icon  would change to .

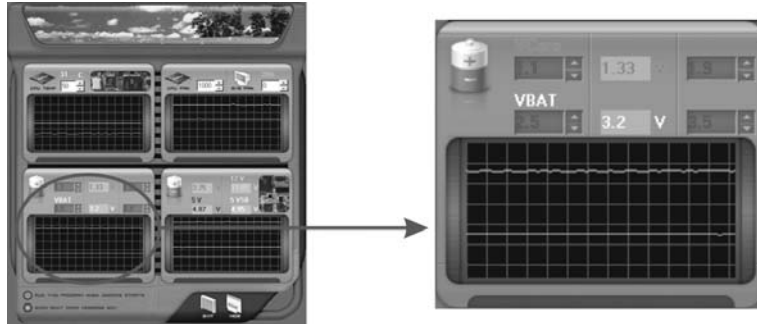

CPU/Battery Voltage



i. VCore

This item displays the CPU voltage, represented by a light blue line.



Users can set the upper and lower limit by adjusting  to monitor the CPU operating voltage.

If CPU voltage is higher or lower than the set value, the status line will change into a red warning line, and a warning sound will alert you. Also, the system tray icon  will change to .

ii. VBAT

This item displays the CMOS battery voltage, represented by a light green line.

Users can set the upper and lower limit by adjusting  to monitor the status of battery voltage.

If battery voltage is higher or lower than the set value, the status line will change to a red warning line, and a warning sound will alert you. Also, the system tray icon  will change to .

Reference data

This column represents the status of power supply voltage and cannot be adjusted, it is only for present status reference.

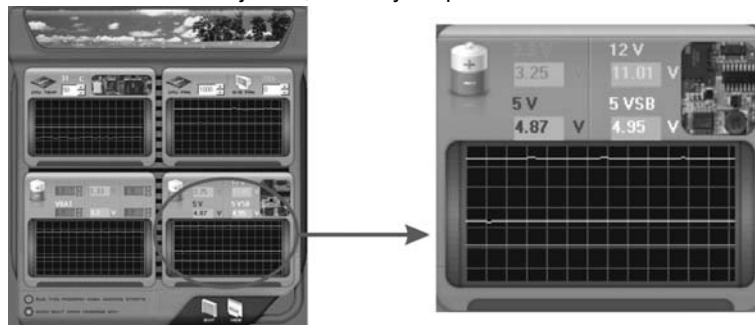

B. Overclocking Configurations

This diagram is designed for T-series Overclocking utility. Friendly interface and solid overclock features are the major concept of this utility.

Graphic 1 will appear when activating this utility.



Graphic 1

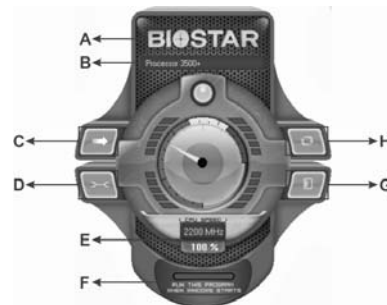

Graphic 2

- A. Clicking on "Biostar" will lead you to the Biostar Homepage.
- B. This column shows the CPU speed information.
- C. Click on this button and the utility will pop-up 4 sub-screens (Please refers to Graphic 3).
- D. Click on this button to minimize this program to taskbar.
- E. This column shows present CPU speed and overclocking percentage.
- F. Clicking on this button will make the program start up as soon as the Windows starts up.
- G. Click on this button to exit this overclock utility.
- H. Click on this button to reset all the overclock features to default setting.

By adjusting the overclocking features in 4 sub-screens, users can tune the system performance to an optimal level.

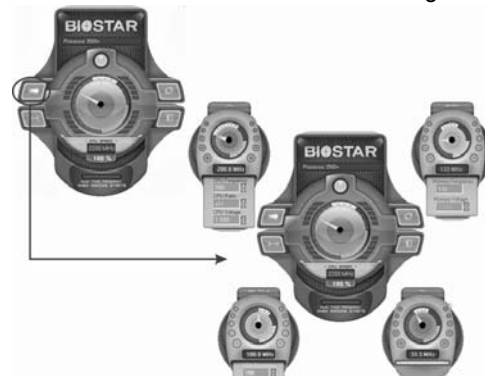

Graphic 3

CPU Overclocking Settings:

By adjusting  can configure three items for CPU overclocking.

A. CPU Frequency

Range: 133MHz~450MHz.
Interval: 1MHz.

B. CPU Ratio

Range: 4~25.
Interval: 1.

C. CPU Voltage

Range: 1.175V~1.725V.
Interval: 0.025V.

Memory Overclocking Settings:

By adjusting  can configure two items for Memory overclocking.

A. Memory Clock Frequency

Choices: 100, 133, 166, 200, 233, 250.

B. Memory Voltage

Range: 2.5V~2.8V.
Interval: 0.1V.

AGP/PCI-Express Overclocking Setting:

By adjusting  can configure VGA card overclocking. And this function helps to increase VGA card performance.

Range: 100MHz~150MHz.
Interval: 1MHz.

PCI Overclocking Setting:



This diagram shows present PCI working status and helps to monitor PCI peripherals working status.
This item cannot be adjusted.

C. Smart Fan Function

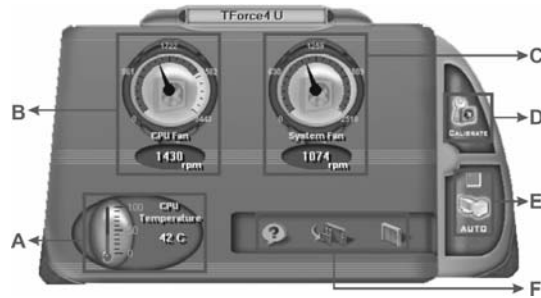

When Smart Fan Function is activated, screens will pop-up to illustrate the fan speed information.

i. CPU Temperature:

Show current CPU temperature.

ii. CPU Fan speed:

Show current CPU Fan speed.

iii. System Fan speed:

Show current system Fan speed.

iv. Calibrate:

When changing CPU Fan or System Fan, click on this button to re-calibrate the Fan speed.

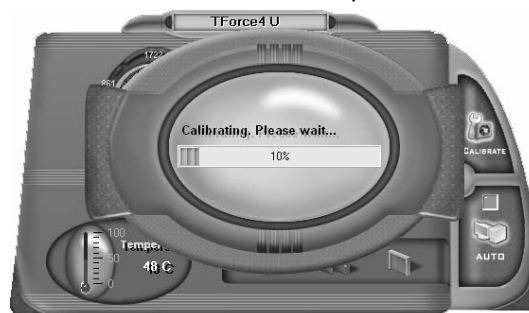

Note:

1. When Smart Fan Function activates for the first time, this calibrate function would auto-run to get upper and lower limitation of CPU Fan and System Fan.
2. When calibrating process is done, the calibrating window will auto-close, and the main screen will show new fan speed data.



v. Auto:

If the green indicator is lit up, the Smart Fan Function is “On” (Default Setting).

Click on this button again to close Smart Fan Function, and a screen as below would pop-up.

There will be pulling-meter besides the CPU Fan and System Fan, the CPU Fan and the System Fan speed can be adjusted by adjusting the Cursor Up or Down.

**vi. Program Tool Bar:**

-  **About:**
Click on this button to get program-related information.
-  **Minimize:**
Click on this button to minimize the program to system tray
-  **Exit:**
Click on this button to exit this program.

D. Live Update

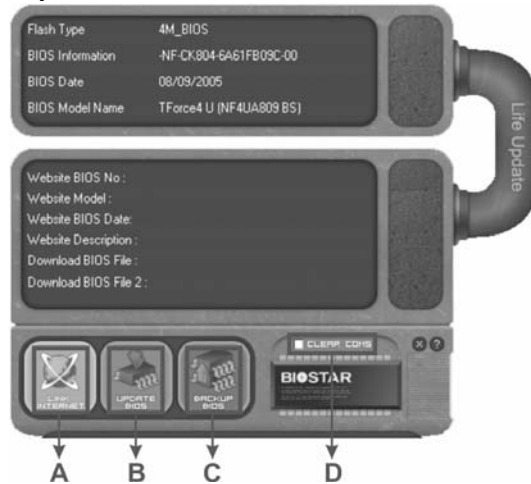

When Live Update program is activated, a screen will pop up to illustrate BIOS related information.

i. Link to Internet:

Click on this button will link to Biostar website and BIOS file will be downloaded.

ii. Update BIOS:

Click on this button to run BIOS flashing process, and it's easy and safe.

iii. Backup BIOS:

Click on this button, and BIOS file will be saved into the user-selected folder.

iv. Clear CMOS:

Click on this item will clear the CMOS Data. When carrying this job, the previous CMOS data would be cleared and returned to default setting.

CHAPTER 5: USEFUL HELP

5.1 DRIVER INSTALLATION NOTE

After you installed your operating system, please insert the Fully Setup Driver CD into your optical drive and install the driver for better system performance.

You will see the following window after you insert the CD

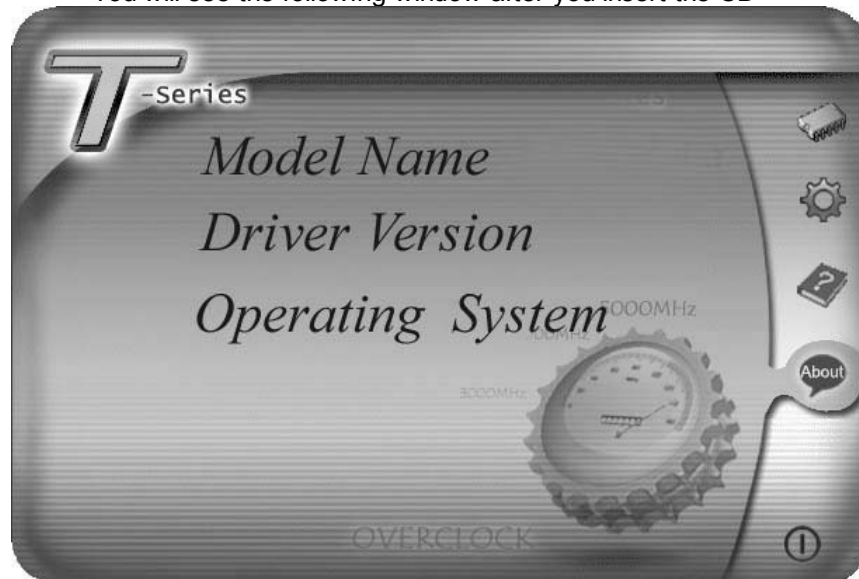

The setup guide will auto detect your motherboard and operating system.

Note:

If this window didn't show up after you insert the Driver CD, please use file browser to locate and execute the file **SETUP.EXE** under your optical drive.



Driver Installation

To install the driver, please click on the Driver icon. The setup guide will list the compatible driver for your motherboard and operating system. Click on each device driver to launch the installation program.



Software Installation

To install the software, please click on the Software icon. The setup guide will list the software available for your system, click on each software title to launch the installation program.

**Manual**

Aside from the paperback manual, we also provide manual in the Driver CD. Click on the Manual icon to browse for available manual.

Note:

You will need Acrobat Reader to open the manual file. Please download the latest version of Acrobat Reader software from <http://www.adobe.com/products/acrobat/readstep2.html>

5.2 AWARD BIOS BEEP CODE

Beep Sound	Meaning
One long beep followed by two short beeps	Video card not found or video card memory bad
High-low siren sound	CPU overheated System will shut down automatically
One Short beep when system boots-up	No error found during POST
Long beeps every other second	No DRAM detected or installed

5.3 EXTRA INFORMATION

A. BIOS Update

After you fail to update BIOS or BIOS is invaded by a virus, the Boot-Block function will help to restore BIOS. If the following message is shown after boot-up of the system, it means the BIOS contents are corrupted.

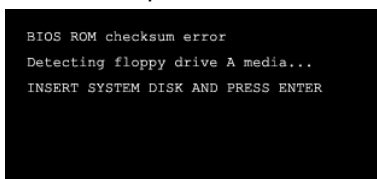

In this case, please follow the procedure below to restore the BIOS:

1. Make a bootable floppy disk.
2. Download the Flash Utility "AWDFLASH.exe" from the Biostar website: www.biostar.com.tw
3. Confirm motherboard model and download the respective BIOS from Biostar website.
4. Copy "AWDFLASH.exe" and respective BIOS onto floppy disk.
5. Insert the bootable disk into floppy drive and press Enter.
6. System will boot-up to DOS prompt.
7. Type "Awdflash xxxx.bf/sn/py/r" in DOS prompt.
8. System will update BIOS automatically and restart.
9. The BIOS has been recovered and will work properly.

B. CPU Overheated

If the system shuts down automatically after power on of system for a few seconds that means the CPU protection function has been activated.

When the CPU is overheated, the motherboard will shutdown automatically to avoid damaging the CPU, and the system will not power on again.

In this case, please double check:

1. The CPU cooler surface is placed evenly with the CPU surface.
2. CPU fan is rotating normally.
3. CPU fan speed is fulfilling the CPU speed.

After confirmation, please follow the steps below to relieve the CPU protection function.

1. Remove the power cord from power supply for a few seconds.
2. Wait for a few seconds.
3. Plug in the power cord and boot up the system.

Or you can:

1. Clear the CMOS data.
(See "JCMOS1: Clear CMOS Header" section)
2. Wait for a few seconds.
3. Power on the system again.

5.4 TROUBLESHOOTING

Problem	Solution
1. No power to the system at all Power light don't illuminate, fan inside power supply does not turn on. 2. Indicator light on keyboard does not turn on.	1. Make sure power cable is securely plugged in. 2. Replace cable. 3. Contact technical support.
System inoperative. Keyboard lights are on, power indicator lights are lit, and hard drive is spinning.	Using even pressure on both ends of the DIMM, press down firmly until the module snaps into place.
System does not boot from hard disk drive, can be booted from optical drive.	1. Check cable running from disk to disk controller board. Make sure both ends are securely plugged in; check the drive type in the standard CMOS setup. 2. Backing up the hard drive is extremely important. All hard disks are capable of breaking down at any time.
System only boots from optical drive. Hard disk can be read and applications can be used but booting from hard disk is impossible.	1. Back up data and application files. 2. Reformat the hard drive. Re-install applications and data using backup disks.
Screen message says "Invalid Configuration" or "CMOS Failure."	Review system's equipment. Make sure correct information is in setup.
Cannot boot system after installing second hard drive.	1. Set master/slave jumpers correctly. 2. Run SETUP program and select correct drive types. Call the drive manufacturers for compatibility with other drives.

GERMAN

CPU

- Unterstützt Sockel 939.
- Unterstützt AMD Athlon 64 FX- / Athlon 64- / Athlon 64 X2-Prozessoren.
- Unterstützt AMD Sempron -Prozessoren.
- AMD 64-Architektur ermöglicht 32- und 64-Bit-Verarbeitung.
- Unterstützt HyperTransport™- und AMD Cool'n'Quiet™-Technologie.

Chipsatz

- NVIDIA nForce4 (TForce4).
- NVIDIA nForce4 Ultra (TForce4 Ultra).
- Unterstützung:
 - Unterstützt NVIDIA Firewall.
 - Unterstützt Gigabit Ethernet.
 - Unterstützt NVIDIA nTune Utility.
 - Unterstützt NVIDIA Secure Networking Processor.

Betriebssystemunterstützung

- Unterstützt Windows 2000 und Windows XP.
Hinweis: Windows 98SE und Windows ME werden nicht unterstützt.

Abmessungen

- ATX-Formfaktor: 29.35cm (L) x 23.4cm (B).

Systemspeicher

- Unterstützt Dual-Kanal DDR.
- Unterstützt DDR333 / DDR400.
- Unterstützt die Speichergröße von maximal 4GB mit 4 DIMM-Steckplätze.

Serial ATA

- nForce4 Ultra unterstützt die Serial ATA 2.0-Spezifikation, datentransferrate von bis zu 3GB/s
- nForce4 unterstützt die Serial ATA 2.0-Spezifikation, datentransferrate von bis zu 1.5GB/s

Super E/A

- Chip: ITE IT8712F.
- Systemumgebungskontrolle:
 - Hardwareüberwachung
 - Lüfterdrehzahl-Controller
 - "Smart Guardian"-Funktion von ITE

IDE

- Zwei integrierte Anschlüsse für 4 Geräte.
- Unterstützt PIO-Modus 0~4, Blockmodus und Ultra DMA 33/66/100/133 Bus-Mastermodus.

AC'97 Sound-Codec

- Chip: ALC850, unterstützt 8 Kanäle.

IEEE 1394A Chip

- Chip: VIA VT6307, unterstützt zwei 1394A Firewire-Anschlüsse jeweils mit einer Geschwindigkeit von bis zu 400Mb/s.

Gigabit Ethernet-LAN

- NVIDIA Gigabit MAC + VITESSE Gigabit PHY VSC8201.
- Unterstützt die ACPI-Energieverwaltung.
- Unterstützt NVIDIA StreamThru-Technologie
 - Isochroner Controller gekoppelt mit Hyper Transport garantiert höchste Netzwerkleistung.

Sicherheit

- NVIDIA Firewall-Technologie
 - Native Firewall-Lösung, schützt den PC durch Filtern unautorisierten Datenverkehrs vor Eindringlingen.
- NVIDIA Active Armor (nur für nForce4 Ultra)
 - Verbesserte Netzwerksicherheit bietet sowohl schnellere als auch sicherere Umgebung.

NVIDIA RAID Technologie

- RAID 0 Disk-Striping für die höchste System- und Applikationsleistung.
- RAID 1 Disk-Mirroring zur Erhöhung der Fehlertoleranz, unterstützt die SATA und ATA-133 Disk-Controller-Standards.
- RAID 0+1 Disk-Striping und -Mirroring für die höchste Leistung mit Fehlertoleranz.

Interne integrierte Steckplätze und Anschlüsse

- 1 PCI-Express x16-Steckplatz
- 1 Xtreme Graphics Steckplatz
- 1 CD-ROM-Audioeingang
- 1 S/PDIF-Ausgangsanschluss
- 2 PCI-Express x1-Steckplätze
- 2 Ultra DMA 133/100/66/33 IDE-Anschlüsse
- 3 PCI-Steckplätze
- 4 Serial ATA-Anschlüsse

Rücktafel-E/A-Anschlüsse

- 1 drucker Anschluss
- 1 RJ-45 LAN-Anschluss
- 1 PS/2-Mausanschluss
- 1 PS/2-Tastaturanschluss
- 1 1394A Firewire-Anschluss
- 1 serieller Anschluss (COM2 optional)
- 4 USB 2.0-Anschlüsse
- 6 Audioanschlüsse für 8-Kanal-Audioausgabefunktionen.

FRENCH

Processeur

- Supporte le socket 939.
- Supporte les processeurs AMD Athlon 64 FX / Athlon 64 / Athlon 64 X2.
- Prise en charge des processeurs AMD Sempron.
- Architecture AMD 64 activant des opérations 32 et 64 bits.
- Supporte les technologies HyperTransport™ et AMD Cool'n'Quiet™.

Chipset

- NVIDIA nForce4 (TForce4).
- NVIDIA nForce4 Ultra (TForce4 Ultra).
- Tous deux prennent en charge:
 - Supporte le firewall NVIDIA.
 - Supporte l'éthernet Gigabit.
 - Supporte l'utilitaire NVIDIA "nTune Utility".
 - Supporte le processeur NVIDIA de réseau sécuritaire (Secure Networking).

Systèmes d'exploitation pris en charge

- Prise en charge de Windows 2000 et Windows XP.
Note: Windows 98SE et Windows ME ne sont pas pris en charge.

Dimensions

- Facteur de forme ATX: 29.35cm (Long) x 23.4cm (Larg)

Mémoire système

- Prise en charge des DDR double canal.
- Prise en charge de DDR333 / DDR400.
- Espace mémoire maximum de 16GB, prenant en charge 4 barrettes DIMM.

ATA Série

- nForce4 Ultra prise en charge des spécifications ATA 2.0 Série, débit de transfert des données jusqu'à 3 Go/s.
- nForce4 prise en charge des spécifications ATA 2.0 Série, débit de transfert des données jusqu'à 1.5 Go/s.

E/S disque

- Chip : ITE IT8712F.
- Initiatives Contrôle d'environnement,
 - Moniteur matériel
 - Contrôleur de vitesse de ventilateur
 - Fonction "Smart Guardian" d'ITE

IDE

- Deux connecteurs sur carte permettant la prise en charge de 4 périphériques.
- Prise en charge PIO mode 0~4, Block Mode et mode bus maître Ultra DMA 33/66/100/133.

Codec audio AC'97

- Chip: ALC850, prise en charge 8 canaux.

Chip IEEE 1394

- Chip: VIA VT6307, prise en charge de deux ports 1394A Firewire jusqu'à 400Mo/s par port.

LAN Ethernet Gigabit

- NVIDIA Gigabit MAC + VITESSE Gigabit PHY VSC8201.
- Prise en charge Gestion de l'alimentation ACPI.
- Prise en charge de la technologie NVIDIA StreamThru
 - Contrôleur isochrone couple l'Hyper Transport donnant des performances réseau plus rapides.

Sécurité

- Technologie de Firewall NVIDIA
 - Solution de firewall natif, protégeant le PC des intrusions extérieures en filtrant le trafic non autorisé.
- NVIDIA Active Armor (Seulement pour nForce4 Ultra)
 - Améliore la sécurité réseau et fournit à l'utilisateur un environnement à la fois rapide et sûr.

Technologie de NVIDIA RAID

- Striping de disque RAID 0 pour des performances système et applications optimales.
- Prise en charge mirroring RAID 1 pour tolérance d'erreurs, prise en charge pour les normes contrôleurs de disque SATA et ATA-133.
- Disques RAID 0+1 en miroir ou en striping pour des performances plus élevées et une plus grande résistance aux pannes.

Emplacements et connecteurs sur carte internes

- 1 emplacement PCI-Express x16
- 1 emplacement Xtreme Graphics
- 1 connecteur S/PDIF-out
- 1 connecteur d'entrée CD-ROM audio-in
- 2 emplacements PCI-Express x1
- 2 connecteurs IDE Ultra DMA 133/100/66/33
- 3 emplacements PCI
- 4 ports série ATA

Connecteurs E/S panneau arrière

- 1 port imprimieur
- 1 prise LAN RJ-45
- 1 port souris PS/2
- 1 port clavier PS/2
- 1 port 1394A Firewire
- 1 port série (COM2 en option)
- 4 ports USB 2.0
- 6 ports audio prenant en charge les équipements de sortie audio 8 voies.

ITALIAN

CPU

- Supporto di Socket 939.
- Supporto di processori AMD Athlon 64 FX / Athlon 64 / Athlon 64 X2.
- Supporto processore AMD Sempron.
- L'architettura AMD 64 abilita la computazione simultanea 32 e 64 bit.
- Supporto delle tecnologie HyperTransport™ e AMD Cool'n'Quiet™.

Chipset

- NVIDIA nForce4 (TForce4).
- NVIDIA nForce4 Ultra (TForce4 Ultra).
- Entrambi supportano:
 - Supporto di NVIDIA Firewall.
 - Supporto di Gigabit Ethernet.
 - Supporto di NVIDIA nTune Utility.
 - Supporto del processore NVIDIA Secure Networking.

Portati

- Supporto di Windows 2000 e Windows XP.
Nota: Non supporta Windows 98SE e Windows ME.

Dimensioni

- Fattore di forma ATX: 29.35cm (L) x 23.4 cm (P)

Memoria di sistema

- Supporto di moduli DDR a doppio canale.
- Supporto di DDR333 /DDR400.
- Lo spazio massimo di memoria è 16GB e supporta 4 prese DIMM.

Serial ATA

- nForce4 Ultra supporto specifiche Serial ATA 2.0, velocità di trasferimento dei dati fino 3GB/s.
- nForce4 supporto specifiche Serial ATA 2.0, velocità di trasferimento dei dati fino 1.5GB/s.

Super I/O

- Chip: ITE IT8712F.
- Funzioni di controllo dell'ambiente:
 - Monitoraggio hardware
 - Controller velocità ventolina
 - Funzione "Smart Guardian" di ITE

IDE

- Due connettori integrati supportano 4 dispositivi.
- Modalità: PIO 0-4, bus master Block e Ultra DMA 33/66/100/133.

Audio Codec AC'97

- Chip: ALC850, supporto di 8 canali.

Chip IEEE 1394A

- Chip: VIA VT6307, supporto di due porte Firewire 1394A con capacità massima individuale di 400Mb/s.

Gigabit Ethernet LAN

- NVIDIA Gigabit MAC + VITESSE Gigabit PHY VSC8201.
- Supporto gestione energetica ACPI.
- Supporto della tecnologia NVIDIA StreamThru
 - Il controller isocrono accoppiato con Hyper Transport produce le più veloci prestazioni di rete.

Protezione

- Tecnologia Firewall NVIDIA
 - Soluzione Firewall Native protegge il PC da intrusioni filtrando il traffico non autorizzato.
- NVIDIA Active Armor (solo per nForce4 Ultra)
 - Migliore la protezione di rete e fornisce agli utenti un ambiente sia rapido sia protetto.

Tecnologia NVIDIA RAID

- Striping del disco RAID 0 per prestazioni superiori del sistema e delle applicazioni.
- Supporto mirroring del disco RAID 1 per la tolleranza errori, supporto di entrambi gli standard controller disco SATA e ATA-133.
- Striping e mirroring disco RAID 0+1 per le massime prestazioni con tolleranza agli errori.

Connettori e alloggiamenti interni integrato

- 1 alloggiamento PCI-Express x16
- 1 alloggiamento Xtreme Graphics
- 1 connettore S/PDIF-out
- 1 connettore ingresso audio CD-ROM
- 2 alloggiamenti PCI-Express x1
- 2 connettori Ultra DMA 133/100/66/33 IDE
- 3 alloggiamenti PCI
- 4 porte Serial ATA

Connettori I/O del pannello posteriore

- 1 porta stampatore
- 1 connettore LAN RJ-45
- 1 porta mouse PS/2
- 1 porta tastiera PS/2
- 1 porta Firewire 1394A
- 1 porta seriale (COM2 optional)
- 4 porte USB 2.0
- 6 porte audio supportano 8 canali di servizio rendimento audio.

SPANISH

Procesador

- Soporta el Socket 939.
- Soporta los procesadores AMD Athlon 64 FX / Athlon 64 /Athlon 64 X2.
- Compatible con el procesador AMD Sempron.
- La arquitectura AMD 64 permite computación de 32 bits y 64 bits de manera simultánea.
- Soporta las tecnologías HyperTransport™ y AMD Cool'n'Quiet™.

Conjunto de chips

- NVIDIA nForce4 (TForce4).
- NVIDIA nForce4 Ultra (TForce4 Ultra).
- Ambos admiten:
 - Soporta el Firewall NVIDIA.
 - Soporta Gigabit Ethernet.
 - Soporta la Utilidad NVIDIA nTune.
 - Soporta el Procesador para Seguridad en Redes NVIDIA.

Sistemas operativos compatibles

- Compatible con Windows 2000 y Windows XP.
Nota: no compatible con Windows 98SE ni Windows ME.

Dimensiones

- Formato ATX: 29.35 cm (LA) x 23.4 cm (AN)

Memoria del sistema

- Compatible con admite DDR de canal dual.
- Compatible con admite DDR266/333/400.
- Espacio máximo de memoria de 4 GB, que admite 4 zócalos DIMM.

Serial ATA

- nForce4 Ultra compatible con la especificación Serial ATA 2.0, tasa de transferencia de datos de hasta 3 GB/s.
- nForce4 compatible con la especificación Serial ATA 2.0, tasa de transferencia de datos de hasta 1.5 GB/s.

Súper E/S

- Procesador: ITE IT8712F.
- Iniciativas de control medioambiental:
 - Supervisor H/W
 - Controlador de la velocidad del ventilador
 - Función "Guardián inteligente" de ITE

IDE

- Dos conectores integrados que admiten 4 dispositivos.
- Admite el modo PIO 0-4, el modo de bloque y el modo de bus maestro Ultra DMA 33/66/100/133.

Códec de audio AC'97

- Procesador: ALC850, admite 8 canales.

Procesador IEEE 1394

- Procesador: VIA VT6307, admite dos puertos 1394A Firewire de hasta 400 Mb/s individualmente.

LAN Ethernet Gigabit

- NVIDIA Gigabit MAC + VITESSE Gigabit PHY VSC8201.
- Admite administración de energía ACPI.
- Admite la tecnología NVIDIA StreamThru
 - Controlador isócrono asociado con Hyper Transport proporciona el mayor rendimiento para interconexión en red.

Seguridad

- Tecnología de Firewall NVIDIA
 - Solución de firewall nativa, protege el computador personal de intrusos al filtrar el tráfico no autorizado.
- NVIDIA Active Armor (solamente para nForce4 Ultra)
 - Mejora la seguridad de la red y proporciona a los usuarios un entorno rápido y seguro.

Tecnología NVIDIA RAID

- Intercalación de disco RAID 0 disk para conseguir el mejor rendimiento del sistema y de las aplicaciones.
- Admite simetría de disco RAID 1 para tolerancia de errores, compatible con las normas de controlador de discos SATA y ATA-133.
- Doble escritura y grabación en disco RAID 0+1 para obtener un mayor rendimiento con tolerancia a fallos.

Conectores y ranuras de E/S integrados e internos

- 1 ranura 16X PCI-Express
- 1 ranura Xtreme Graphics
- 1 conector de salida S/PDIF
- 1 conector de entrada de audio en CD-ROM
- 2 ranuras 1X PCI-Express
- 2 conectores Ultra DMA 133/100/66/33 IDE
- 3 ranuras PCI
- 4 puertos Serial ATA

Back Conectores de E/S del panel posterior

- 1 puerto impresora
- 1 conector de red LAN RJ-45
- 1 puerto para ratón PS/2
- 1 puerto para teclado PS/2
- 1 puerto 1394A Firewire
- 1 puerto serie (COM2 opcional)
- 4 puertos USB 2.0
- 6 puertos de audio que admiten 8 conexiones de salida de audio de 8 canales.

PORTUGUESE

CPU

- Suporta o socket 939.
- Suporta processadores AMD Athlon 64 FX / Athlon 64 / Athlon 64 X2.
- Suporta um processador AMD Sempron.
- A arquitectura AMD 64 permite uma computação de 32 e 64 bits em simultâneo.
- Suporta a tecnologia HyperTransport™ e AMD Cool'n'Quiet™.

Chipset

- NVIDIA nForce4 (TForce4).
- NVIDIA nForce4 Ultra (TForce4 Ultra).
- Suporte:
 - Suporta a firewall NVIDIA.
 - Suporta a Ethernet Gigabit.
 - Suporta o utilitário NVIDIA nTune.
 - Suporta o processador NVIDIA Secure Networking.

Sistemas operativos suportados:

- Suporta o Windows 2000 e o Windows XP.
Nota: Não suporta o Windows 98SE e o Windows ME.

Dimensões

- Factor de forma ATX: 29.35 cm (C) x 23.4 cm (L)

Memória do sistema

- Suporta DDR de duplo canal.
- Suporta módulos DDR333 / DDR400.
- Capacidade máxima da memória: 4GB, suportando 4 sockets DIMM.

Serial ATA

- nForce4 Ultra suporta a especificação Serial ATA 2.0, velocidade de transferência de dados até 3 GB/s.
- nForce4 suporta a especificação Serial ATA 2.0, velocidade de transferência de dados até 1.5 GB/s.

Especificação Super I/O

- Chip: ITE IT8712F.
- Iniciativas para controlo do ambiente,
 - Monitorização do hardware
 - Controlador da velocidade da ventoinha
 - Função "Smart Guardian" da ITE

IDE

- Dois conectores na placa para 4 dispositivos.
- Suporta o modo PIO 0-4, o modo Block e o modo bus master Ultra DMA 33/66/100/133.

Codec de som AC'97

- Chip: ALC850, suporta 8 canais.

Chip IEEE 1394A

- Chip: VIA VT6307, suporta duas portas Firewire 1394A até 400 Mb/s para cada uma

LAN Ethernet Gigabit

- NVIDIA Gigabit MAC + VITESSE Gigabit PHY VSC8201.
- Suporta a gestão de energia ACPI.
- Suporta a tecnologia NVIDIA StreamThru
 - Controlador isócrono combinado com a arquitectura Hyper Transport para um desempenho mais rápido ao nível da rede.

Segurança

- Tecnologia de firewall NVIDIA
 - Firewall nativa, para protecção do PC contra intrusos através da filtragem de tráfego não autorizado.
- NVIDIA Active Armor (apenas para os modelos nForce4 Ultra)
 - Melhora a segurança da rede e proporciona aos utilizadores um ambiente rápido e seguro.

Tecnologia NVIDIA RAID

- RAID 0 função "disk striping" para um melhor desempenho por parte do sistema e das aplicações.
- RAID 1 suporta a função "disk mirroring" para tolerância de falhas, suporta as normas SATA e ATA-133 ao nível do controlador do disco.
- Suporta as funções RAID 0+1 "disk striping" e "mirroring" para um desempenho superior com tolerância de falhas.

Conectores e ranhuras internos na placa

- 1 ranhura PCI Express x16
- 1 ranhura Xtreme Graphics
- 1 conector S/PDIF-Out
- 1 conector CD-ROM para entrada de áudio
- 2 ranhuras PCI Express x1
- 2 conectores Ultra DMA 133/100/66/33 IDE
- 3 ranhuras PCI
- 4 portas Serial ATA

Conectores I/O do painel traseiro

- 1 porta impressora
- 1 tomada LAN RJ-45
- 1 porta para rato PS/2
- 1 porta para teclado PS/2
- 1 porta Firewire 1394A
- 1 porta série (COM2 opcional)
- 4 portas USB 2.0
- 6 portas de áudio para saída de 8 canais de áudio.

POLAND

PROCESOR

- Obsługa gniazd Socket 939.
- Obsługa procesorów AMD Athlon 64 FX / Athlon 64 / Athlon 64 X2.
- Obsługa procesorów AMD Sempron
- Architektura AMD 64 umożliwiająca jednoczesne przetwarzanie 32 i 64 bitowe.
- Obsługa technologii HyperTransport™ oraz AMD Cool'n'Quiet™.

Chipset

- NVIDIA nForce4 (TForce4).
- NVIDIA nForce4 Ultra (TForce4 Ultra).
- Obsługa:
 - Obsługa firewalla NVIDIA.
 - Obsługa Gigabit Ethernet.
 - Obsługa programu narzędziowego NVIDIA nTune.
 - Obsługa procesora NVIDIA Secure Networking.

Obsługiwane systemy operacyjne

- Obsługa Windows 2000 oraz Windows XP.
- Uwaga:** *Brak obsługi Windows 98SE oraz Windows ME.*

Wymiary

- Obudowa ATX: 29.35cm (D) x 23.4cm (S)

Pamięć systemowa

- Obsługa DDR dual channel.
- Obsługa DDR333 / DDR400.
- Maksymalna wielkość pamięci wynosi 16GB z obsługą 4 gniazd DIMM.

Serial ATA

- nForce4 Ultra obsługa specyfikacji Serial ATA 2.0, transfer danych do 3GB/s.
- nForce4 obsługa specyfikacji Serial ATA 1.0, transfer danych do 1.5GB/s.

Super I/O

- Chip: ITE IT8712F
- Inicjatywy kontroli środowiska,
 - Monitor H/W
 - Kontroler prędkości wentylatora
 - Funkcja ITE "Smart Guardian"

IDE

- Dwa wbudowane złącza z możliwością obsługi 4 urządzeń.
- Obsługa trybu PIO 0-4, Block Mode (tryb Blok) oraz tryb magistrali głównej Ultra DMA 33/66/100/133.

Kodek dźwięku AC'97

- Chip: ALC850, obsługa 8 kanałów.

Chip IEEE 1394

- Chip: VIA VT6307, obsługa dwóch portów 1394A Firewire o indywidualnej szybkości do 400Mb/s.

Sieć LAN Gigabit Ethernet

- NVIDIA Gigabit MAC + VITESSE Gigabit PHY VSC8201.
- Obsługa zarządzania zasilaniem ACPI.
- Obsługa technologii NVIDIA StreamThru
 - Izochroniczny kontroler sparowany z Hyper Transport, zapewnia najszybsze działanie sieci.

Bezpieczeństwo

- Technologia NVIDIA Firewall
 - Własny firewall, zabezpieczający komputer przed intruzami poprzez filtrowanie nieautoryzowanego ruchu.
- NVIDIA Active Armor (wyłącznie dla nForce4 Ultra)
 - Zwiększa zabezpieczenia sieci i udostępnia użytkownikom szybkie i bezpieczne środowisko.

Technologii NVIDIA RAID

- RAID 0 striping dysku (paskowanie danych) w celu uzyskania najwyższej wydajności systemu i aplikacji.
- Obsługa RAID 1 mirroring dysku (lustrzane odbicie) dla zapewnienia tolerancji błędów, obsługa standardów kontrolera dysków SATA oraz ATA-133.
- RAID 0+1 z paskowaniem danych i mirroringiem celu zapewnienia najwyższej wydajności z tolerancją błędów.

Wewnętrzne, wbudowane gniazda oraz złącza

- 1 gniazdo PCI-Express x16
- 1 gniazdo Xtreme Graphics
- 1 złącze wyjścia S/PDIF
- 1 złącze wejścia audio CD-ROM
- 2 gniazda PCI-Express x1
- 2 złącza Ultra DMA 133/100/66/33 IDE
- 3 gniazda PCI
- 4 porty Serial ATA

Złącza I/O na panelu tylnym

- 1 port drukarki
- 1 gniazdo LAN RJ-45
- 1 port myszy PS/2
- 1 port klawiatury PS/2
- 1 port Firewire 1394A
- 1 port szeregowy (COM2 opcjonalny)
- 4 porty USB 2.0
- 6 portów audio obsługujące 8 kanałów wyjścia audio.

RUSSIAN

Процессор

- Поддерживает гнездо 939..
- Поддерживает процессоры AMD Athlon 64 FX, Athlon 64, Athlon 64 X2
- Поддерживает процессоры AMD Sempron.
- Архитектура AMD 64 допускает одновременную работу в 32-разрядном и 64-разрядном режимах.
- Поддерживает технологии HyperTransport™ и AMD Cool'n'Quiet™

Набор микросхем

- NVIDIA nForce4 (TForce4).
- NVIDIA nForce4 Ultra (TForce4 Ultra).
- Поддерживают оба:
 - Поддерживает брандмауэр NVIDIA.
 - Поддерживает сетевой интерфейс Gigabit Ethernet.
 - Поддерживает программу NVIDIA nTune.
 - Поддерживает процессор NVIDIA Secure Networking Processor.

Поддерживаемые операционные системы

- Поддерживает Windows 2000 и Windows XP.
- Примечание: не поддерживает Windows 98SE и Windows ME.*

Размеры

- Форм-фактор ATX: 29.35cm (L) x 23.4cm (W)

Системная память

- Поддержка двухканальной памяти DDR.
- Поддерживает DDR333 / DDR400.
- Максимальный объем памяти 16 Гб в 4 гнездах DIMM.

Serial ATA

- nForce4 Ultra поддерживает спецификацию Serial ATA 2.0, скорость передачи данных до или 3 Гб/с.
- nForce4 поддерживает спецификацию Serial ATA 2.0, скорость передачи данных до или 1.5 Гб/с.

Супер ввод-вывод

- Контроллер: ITE IT8712F.
- Функции управления режимом эксплуатации,
 - Монитор состояния оборудования
 - Контроллер скорости вентиляторов
 - Функция «Smart Guardian» компании ITE

IDE

- Два встроенных разъема поддерживают подключение четырех жестких дисков IDE.
- Поддержка режимов PIO 0~4, Block Mode и Ultra DMA 33/66/100/133.

Звуковой кодек AC'97

- Контроллер::ALC850, поддерживает 8-канальный звук.

Контроллер IEEE 1394A

- Контроллер: VIA VT6307, поддерживает два порта 1394A Firewire со скоростью каждого порта до 400 Мбит/с.

Гигабитный интерфейс Ethernet

- NVIDIA Gigabit MAC + VITESSE Gigabit PHY VSC8201.
- Поддерживает управление питанием ACPI.
- Поддержка технологии NVIDIA StreamThru
 - Изохронный контроллер, объединенный с шиной HyperTransport для обеспечения повышенной производительности в сети.

Безопасность

- Технология брандмауэра NVIDIA
 - Встроены брандмауэр защищает ПК от взломщиков, отфильтровывая неразрешенный трафик.
- Межсетевой экран NVIDIA Active Armor (только для nForce4 Ultra)
 - Обеспечивает безопасность и скорость сетевых подключений.

Технологии NVIDIA RAID

- Чередование дисков RAID 0 обеспечивает самую высокую производительность системы и приложений.
- Зеркалирование дисков RAID 1 обеспечивает отказоустойчивость для дисков с интерфейсом SATA и ATA-133.
- Чередующиеся и зеркальные дисковые массивы RAID 0+1 обеспечивают максимальную производительность и отказоустойчивость.

Встроенные разъемы ввода-вывода

- 1 слот PCI Express x16
- 1 слот Xtreme Graphics
- 1 разъем S/PDIF-выхода
- 1 Один входной разъем звукового сигнала с привода для компакт-дисков
- 2 слота PCI Express x1
- 2 разъем Ultra DMA 133/100/66/33 IDE
- 3 слота PCI
- 4 порта Serial ATA

Разъемы ввода-вывода на задней панели

- 1 порт принтер
- 1 гнездо RJ-45 ЛВС
- 1 порт мыши PS/2
- 1 порт клавиатуры PS/2
- 1 порт 1394A Firewire
- 1 последовательный порт
- 4 порта USB 2.0
- 6 звуковых портов поддерживают подключение 8 каналов аудиовыхода.

ARABIC

وحدة المعالجة المركزية (CPU)

- تدعم قاعدة توصيل 939.
- تدعم معالجات Athlon 64 X2 / Athlon 64 / AMD Athlon 64 FX.
- تدعم معالجات AMD Sempron processor.
- تدعم بنية AMD 64 الحساب المتزامن 32 و 64 بت.
- تدعم تقنية AMD Cool'n'Quiet™ و HyperTransport™.

مجموعة الشرائح

- NVIDIA nForce4 (TForce4).
- NVIDIA nForce4 Ultra (TForce4 Ultra).
- كلا منهما يدعم:
- تدعم حائط الحماية عبر الإنترنت "NVIDIA".
- تدعم Gigabit Ethernet.
- تدعم أداة المساعدة "NVIDIA nTune".
- تدعم معالج الشبكات المؤمنة "NVIDIA".

نظم التشغيل المدعومة

- يدعم Windows XP و Windows 2000.
- ملاحظة: لا يوجد دعم لنظامي تشغيل Windows ME و Windows 98SE.

الأبعاد

عامل نموذج ATX: 29.35 سم (الطول) × 23.4 سم (العرض)

ذاكرة النظام

- دعم الذاكرة DDR ثنائية القناة.
- تدعم 333/400 DDR.
- أقصى مساحة للذاكرة 4 جيجابايت، مع دعم 4 منافذ DIMM.

سلسلة ATA

- يتوافق nForce4Ultra مع مواصفات SATA 2.0 وذلك بخصوص معدل نقل بيانات الذي يصل إلى 3 جيجا في الثانية.
- يتوافق nForce4 مع مواصفات SATA 2.0 وذلك بخصوص معدل نقل بيانات الذي يصل إلى 1.5 جيجا في الثانية.

دخل/خرج فائق

- الشريحة: ITE IT8712F.
- مبادرات التحكم في البيئة،
- مراقبة H/W
- وحدة تحكم في سرعة المروحة
- ITE وظيفته "الواقي الذكي" من

IDE

- موصلان على اللوحة يدعمان أربعة أجهزة.
- دعم وضع الدخل/الخرج المبرمج (PIO) 0-4، ووضع القفل والأوضاع الرئيسية للنقل من خلال الوصول الفائق للذاكرة مباشرة (Ultra DMA 33/66/100/133).

شفرة صوت AC'97

- الشريحة: ALC850، يدعم ثنائي قنوات.

شريحة IEEE 1394 (اختياري)

- VI الشريحة: VIA VT6307, تدعم منفذ 1394A Firewire تصل قدرة كل منهما إلى 400 ميجا بايت/الثانية.

الشبكة المحلية

- VSC PHY Gigabit EESSVIT8201 +MAC Gigabit NVIDIA
- ودعم إدارة الطاقة من خلال ACPI.
- دعم تقنية NVIDIA StreamThru
- وحدة تحكم تزامنية مقترنة بتقنية Hyper Transport مما يوفر أسرع معدل لإداء الشبكات.

التأمين

- دعم تقنية NVIDIA Firewall
- حل حائط الحماية الأصلي والتي تحمي الحاسب الشخصي من الدخلاء من خلال تصفية المرور غير المصرح.
- تقنية NVIDIA Active Armor (في nForce4 Ultra فقط)
- تحسين مستوى سرية الشبكات مع توفير معدلات أعلى من السرعة والسرية للمستخدم.

دعم تقنية NVIDIA RAID

- تقسيم قرص 0 ل RAID إلى شرائط لتحقيق أفضل أداء للنظام والتطبيق
- دعم عمل نسخة مطابقة من القرص 1 ل RAID لدعم التسامح مع الخطأ بالنسبة لكل من معايير جهاز التحكم في الأقراص SATA وATA-133.
- RAID 0+1 تخطيط وعكس الأقراص مع نسبة تسامح في وجود أخطاء.

منافذ توصيل وفتحات اللوحة الداخلية

- 1 فتحة PCI-Express 1 ×
- 1 فتحة PCI-Express 16 ×
- 1 منفذ توصيل خرج SPDIF-Out واحد
- 1 منفذ توصيل دخل صوت CD-ROM واحد
- 2 منفذا توصيل IDE Ultra DMA 133/100/66/33
- 3 فتحتان PCI
- 4 منفذان SATA II

موصلات المدخلات/المخرجات باللوحة الخلفية

- 1 منفذ طباعة
- 1 قابس RJ-45 LAN
- 1 منفذ ماوس PS/2
- 1 منفذ لوحة مفاتيح PS/2
- 1 منفذ 1394A Firewire
- 1 منفذ تسلسلي (COM2 اختياري)
- 4 منافذ USB 2.0
- 6 منافذ صوتية تدعم تسهيلات خرج صوت 8 قنوات.

JAPANESE

CPU

- Socket 939 をサポート。
- AMD Athlon 64 FX / Athlon 64 / Athlon 64 X2 プロセッサをサポート。
- AMD Sempron プロセッサをサポート。
- AMD 64 アーキテクチャにより 32 ビットと 64 ビットの同時コンピューティングが可能。
- HyperTransport™ および AMD Cool'n'Quiet™ テクノロジーをサポート。

チップセット

- NVIDIA nForce4 (TForce4).
- 下記に両方とも対応:
 - NVIDIA ファイアウォールをサポート。
 - Gigabit イーサネットをサポート。
 - NVIDIA nTune ユーティリティをサポート。
 - NVIDIA セキュアネットワークングプロセッサをサポート。

サポートするオペレーティングシステム

- Windows 2000、Windows XP をサポート。
注: Windows 98SE と Windows ME では対応していません。

サイズ

- ATX フォームファクタ: 29.35cm (長さ) x 23.4cm (幅)

システムメモリ

- デュアルチャンネル DDR をサポート。
- DDR333 / DDR400 をサポート。
- 最大メモリ容量 16GB、4 つの DIMM ソケットをサポート。

シリアル ATA

- nForce4 Ultra シリアル ATA 2.0 仕様をサポート、最大 3GB/秒のデータ転送速度。
- nForce4 シリアル ATA 1.0 仕様をサポート、最大 1.5GB/秒のデータ転送速度。

スーパー I/O

- チップ: ITE IT8712F。
- 環境コントロールイニシアチブ、
 - H/W モニタ
 - ファン速度コントローラ
 - ITE「スマート・ガーディアン」機能

IDE

- 2 つのオンボードコネクタが 4 つのデバイスをサポート。
- PIO モード 0-4、ブロックモード、ウルトラ DMA 33/66/100/133

バス・マスターモードに対応。

AC' 97 オーディオ サウンド・コーデック

- チップ: ALC850, 8 チャンネルをサポート。

IEEE 1394 チップ

- チップ: VIA VT6307, 最大 400Mb/秒の 2 つの 1394A Firewire ポートを個別にサポート。

Gigabit イーサネット LAN

- NVIDIA Gigabit MAC + VITESSE Gigabit PHY VSC8201。
- ACPI 電源管理をサポート。
- NVIDIA StreamThru テクノロジーに対応
 - アイソクロナスコントローラとハイパートランスポートの組み合わせによる、最速のネットワーキング性能。

Security セキュリティ

- NVIDIA ファイアウォールテクノロジー
 - ネーティブなファイアウォールソリューションが、不正トラヒックのフィルタリングによる侵入から PC を保護します。
- NVIDIA Active Armor に対応 (nForce4 Ultra のみ)
 - ネットワークのセキュリティを強化し、ユーザに速くて安全な環境を提供。

NVIDIA RAID テクノロジー

- RAID 0 ディスクストライピングで最高のシステムおよびアプリケーションパフォーマンスを実現。
- RAID 1 ディスクミラーリングがフォールトトレランスをサポート、SATA と ATA-133 ディスクコントローラ標準を共にサポート。
- フォールトトレランスのある最高性能を実現するための RAID 0+1 ディスク ストライピングおよびミラーリング機能。

内部オンボードスロットとコネクタ

- PCI-Express x16 スロット(x1)
- Xtreme Graphics スロット(x1)
- S/PDIF アウトコネクタ(x1)
- CD-ROM オーディオインコネクタ(x1)
- PCI-Express x1 スロット(x2)
- Ultra DMA 133/100/66/33 IDE コネクタ(x2)
- PCI スロット(x3)
- シリアルポート(x4)。

背面パネル I/O コネクタ

- プリンター ポート (x1)
- RJ-45 LAN ジャック(x1)
- PS/2 マウスポート(x1)
- PS/2 キーボードポート(x1)
- 1394A Firewire ポート

- シリアルポート(x1) (COM2 オプション)
- USB 2.0 ポート(x4)
- 6つのオーディオポートが8つのチャンネルオーディオアウト機能をサポート。

04/13, 2006

TForce4 /TForce4 Ultra BIOS Setup

BIOS Setup.....	1
1 Main Menu	3
2 Standard CMOS Features	6
3 Advanced BIOS Features.....	8
4 Advanced Chipset Features.....	12
5 Integrated Peripherals	14
6 Power Management Setup.....	19
7 PnP/PCI Configurations	22
8 PC Health Status.....	24
9 Over Clock Navigator Engine	27
10 CMOS Reload Program(C.R.P.).....	33

BIOS Setup

Introduction

This manual discussed Award™ Setup program built into the ROM BIOS. The Setup program allows users to modify the basic system configuration. This special information is then stored in battery-backed RAM so that it retains the Setup information when the power is turned off.

The Award BIOS™ installed in your computer system's ROM (Read Only Memory) is a custom version of an industry standard BIOS. This means that it supports Intel Pentium® 4 processor input/output system. The BIOS provides critical low-level support for standard devices such as disk drives and serial and parallel ports.

Adding important has customized the Award BIOS™, but nonstandard, features such as virus and password protection as well as special support for detailed fine-tuning of the chipset controlling the entire system.

The rest of this manual is intended to guide you through the process of configuring your system using Setup.

Plug and Play Support

These AWARD BIOS supports the Plug and Play Version 1.0A specification. ESCD (Extended System Configuration Data) write is supported.

EPA Green PC Support

This AWARD BIOS supports Version 1.03 of the EPA Green PC specification.

APM Support

These AWARD BIOS supports Version 1.1&1.2 of the Advanced Power Management (APM) specification. Power management features are implemented via the System Management Interrupt (SMI). Sleep and Suspend power management modes are supported. Power to the hard disk drives and video monitors can be managed by this AWARD BIOS.

ACPI Support

Award ACPI BIOS support Version 1.0 of Advanced Configuration and Power interface specification (ACPI). It provides ASL code for power management and device configuration capabilities as defined in the ACPI specification, developed by Microsoft, Intel and Toshiba.

PCI Bus Support

This AWARD BIOS also supports Version 2.1 of the Intel PCI (Peripheral Component Interconnect) local bus specification.

DRAM Support

DDR SDRAM (Double Data Rate Synchronous DRAM) is supported.

TForce4 / TForce4 Ultra

Supported CPUs

This AWARD BIOS supports the AMD CPU.

Using Setup

In general, you use the arrow keys to highlight items, press <Enter> to select, use the <PgUp> and <PgDn> keys to change entries, press <F1> for help and press <Esc> to quit. The following table provides more detail about how to navigate in the Setup program by using the keyboard.

Keystroke	Function
Up arrow	Move to previous item
Down arrow	Move to next item
Left arrow	Move to the item on the left (menu bar)
Right arrow	Move to the item on the right (menu bar)
Move Enter	Move to the item you desired
PgUp key	Increase the numeric value or make changes
PgDn key	Decrease the numeric value or make changes
+ Key	Increase the numeric value or make changes
- Key	Decrease the numeric value or make changes
Esc key	Main Menu – Quit and not save changes into CMOS Status Page Setup Menu and Option Page Setup Menu – Exit Current page and return to Main Menu
F1 key	General help on Setup navigation keys
F5 key	Load previous values from CMOS
F7 key	Load the optimized defaults
F10 key	Save all the CMOS changes and exit

1 Main Menu

Once you enter Award BIOS™ CMOS Setup Utility, the Main Menu will appear on the screen. The Main Menu allows you to select from several setup functions. Use the arrow keys to select among the items and press <Enter> to accept and enter the sub-menu.

!! WARNING !!

The information about BIOS defaults on manual (**Figure 1,2,3,4,5,6,7,8,9**) is just for reference, please refer to the BIOS installed on board, for update information.

■ **Figure 1. Main Menu**

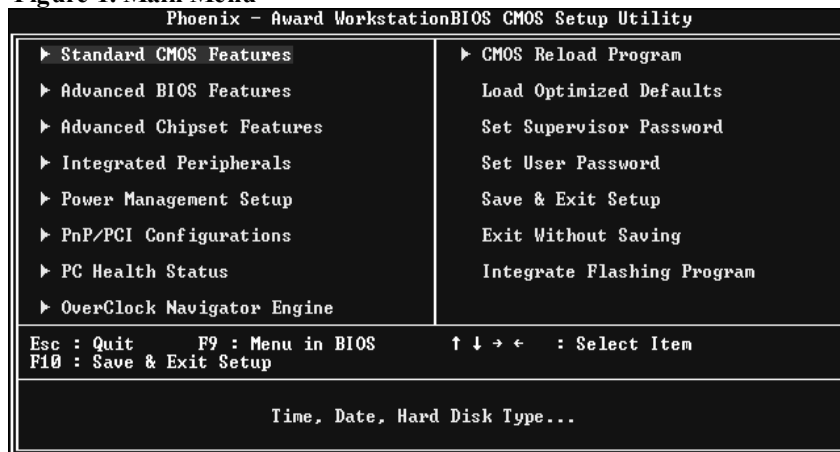

Standard CMOS Features

This submenu contains industry standard configurable options.

Advanced BIOS Features

This submenu allows you to configure enhanced features of the BIOS.

Advanced Chipset Features

This submenu allows you to configure special chipset features.

Integrated Peripherals

This submenu allows you to configure certain IDE hard drive options and Programmed Input/ Output features.

Power Management Setup

This submenu allows you to configure the power management features.

TForce4 / TForce4 Ultra

PnP/PCI Configurations

This submenu allows you to configure certain “Plug and Play” and PCI options.

PC Health Status

This submenu allows you to monitor the hardware of your system.

OverClock Navigator Engine (O.N.E.)

ONE provides two powerful overclock engines, MOS & AOS for both overclock expertises and beginners.

Load Optimized Defaults

This selection allows you to reload the BIOS when the system is having problems particularly with the boot sequence. These configurations are factory settings optimized for this system. A confirmation message will be displayed before defaults are set.

```
Load Optimized Defaults <Y/N>? N
```

Set Supervisor Password

Setting the supervisor password will prohibit everyone except the supervisor from making changes using the CMOS Setup Utility. You will be prompted with to enter a password.

```
Enter Password:
```

Set User Password

If the Supervisor Password is not set, then the User Password will function in the same way as the Supervisor Password. If the Supervisor Password is set and the User Password is set, the “User” will only be able to view configurations but will not be able to change them.

```
Enter Password:
```

Save & Exit Setup

Save all configuration changes to CMOS(memory) and exit setup. Confirmation message will be displayed before proceeding.

```
SAUE to CMOS and EXIT <Y/N>? Y
```

TForce4 / TForce4 Ultra

Exit Without Saving

Abandon all changes made during the current session and exit setup. confirmation message will be displayed before proceeding.

```
Quit Without Saving <Y/N>? N
```

Integrate Flashing Program

This is a very safe way to upgrade BIOS.

By pressing "Enter" key for three times, and the upgrading process will be completed easily.

```
BIOS UPDATE UTILITY <Y/N>? Y
```

2 Standard CMOS Features

The items in Standard CMOS Setup Menu are divided into 10 categories. Each category includes no, one or more than one setup items. Use the arrow keys to highlight the item and then use the <PgUp> or <PgDn> keys to select the value you want in each item.

■ Figure 2. Standard CMOS Setup

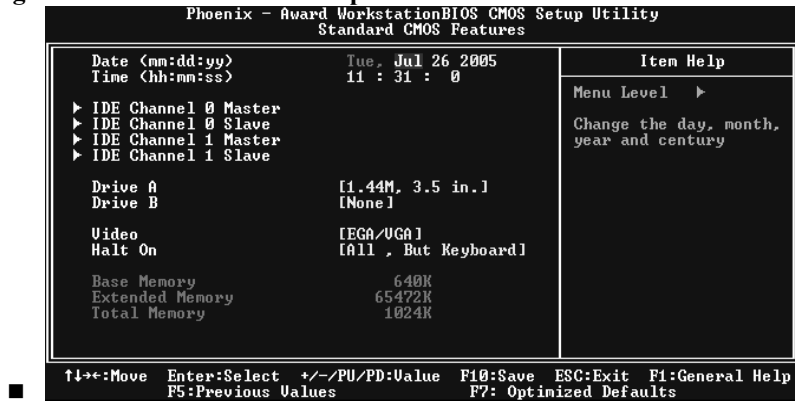

TForce4 / TForce4 Ultra

Main Menu Selections

This table shows the selections that you can make on the Main Menu.

Item	Options	Description
Date	mm : dd : yy	Set the system date. Note that the 'Day' automatically changes when you set the date.
Time	hh : mm : ss	Set the system internal clock.
IDE Primary Master	Options are in its sub menu.	Press <Enter> to enter the sub menu of detailed options
IDE Primary Slave	Options are in its sub menu.	Press <Enter> to enter the sub menu of detailed options.
IDE Secondary Master	Options are in its sub menu.	Press <Enter> to enter the sub menu of detailed options.
IDE Secondary Slave	Options are in its sub menu.	Press <Enter> to enter the sub menu of detailed options.
Drive A Drive B	360K, 5.25 in 1.2M, 5.25 in 720K, 3.5 in 1.44M, 3.5 in 2.88M, 3.5 in None	Select the type of floppy disk drive installed in your system.
Video	EGA/VGA CGA 40 CGA 80 MONO	Select the default video device.
Halt On	All Errors No Errors All, but Keyboard All, but Diskette All, but Disk/ Key	Select the situation in which you want the BIOS to stop the POST process and notify you.
Base Memory	N/A	Displays the amount of conventional memory detected during boot up.
Extended Memory	N/A	Displays the amount of extended memory detected during boot up.
Total Memory	N/A	Displays the total memory available in the system.

3 Advanced BIOS Features

■ Figure 3. Advanced BIOS Setup

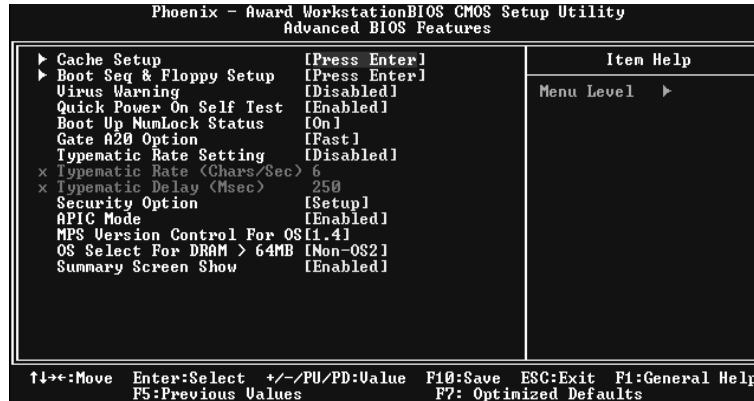

Cache Setup

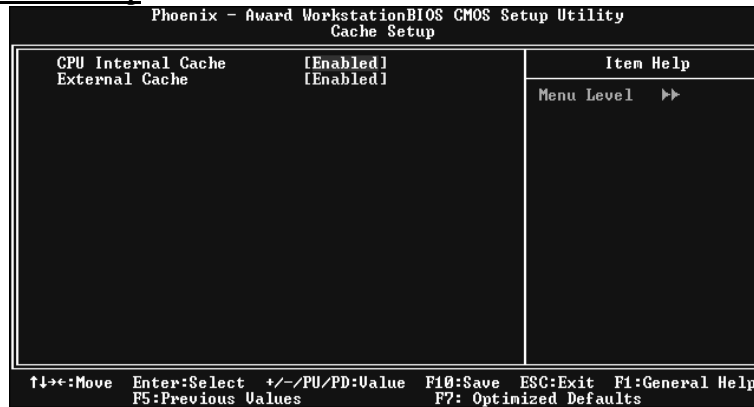

These BIOS attempt to load the operating system from the device in the sequence selected in these items.

CPU Internal Cache

Depending on the CPU/chipset in use, you may be able to increase memory access time with this option.

- Enabled** (default) Enable cache.
- Disabled Disable cache.

External Cache

This option enables or disables “Level 2” secondary cache on the CPU, which may improve performance.

- The Choices:** **Enabled** (default) Enable cache.
- Disabled Disable cache.

TForce4 / TForce4 Ultra

Boot Seq & Floppy Setup

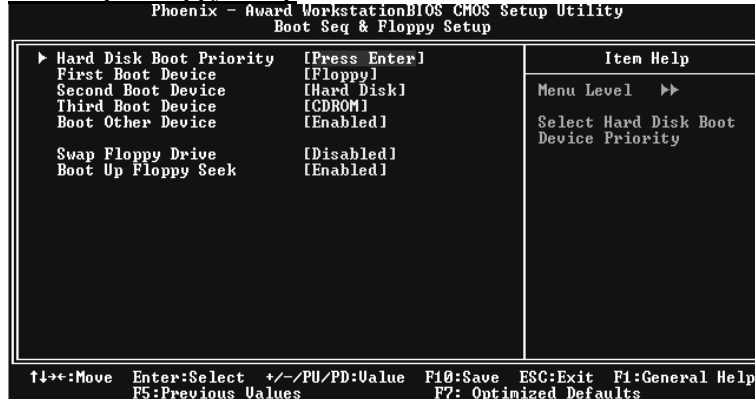

Hard Disk Boot Priority



These BIOS attempt to load the operating system from the device in the sequence selected in these items.

The Choices: Pri. Master, Pri. Slave, Sec. Master, Sec. Slave, USBHDD0, USB HDD1, USB HDD2, and Bootable Add-in Cards.

First/ Second/ Third/ Boot Other Device

These BIOS attempt to load the operating system from the devices in the sequence selected in these items.

The Choices: Floppy, LS120, HDD-0, SCSI, CDROM, HDD-1, HDD-2, HDD-3, ZIP100, LAN, Disabled.

Swap Floppy Drive

For systems with two floppy drives, this option allows you to swap logical drive assignments.

The Choices: Disabled (default), Enabled.

TForce4 / TForce4 Ultra

Boot Up Floppy Seek

Enabling this option will test the floppy drives to determine if they have 40 or 80 tracks. Disabling this option reduces the time it takes to boot-up.

The Choices: **Enabled** (default), Disabled.

Virus Warning

This option allows you to choose the Virus Warning feature that is used to protect the IDE Hard Disk boot sector. If this function is enabled and an attempt is made to write to the boot sector, BIOS will display a warning message on the screen and sound an alarm beep.

Disabled (default) Virus protection is disabled.

Enabled Virus protection is activated.

Quick Power On Self Test

Enabling this option will cause an abridged version of the Power On Self-Test (POST) to execute after you power up the computer.

Enabled (default) Enable quick POST.

Disabled Normal POST.

Boot Up NumLock Status

Selects the NumLock. State after power on.

On (default) Numpad is number keys.

Off Numpad is arrow keys.

Gate A20 Option

Select if chipset or keyboard controller should control Gate A20.

Normal A pin in the keyboard controller controls Gate A20.

Fast (default) Lets chipset control Gate A20.

Typematic Rate Setting

When a key is held down, the keystroke will repeat at a rate determined by the keyboard controller. When enabled, the typematic rate and typematic delay can be configured.

Disabled (default)

Enabled

Typematic Rate (Chars/Sec)

Sets the rate at which a keystroke is repeated when you hold the key down.

The Choices: **6** (default), 8,10,12,15,20,24,30.

Typematic Delay (Msec)

Sets the delay time after the key is held down before it begins to repeat the keystroke.

The Choices: **250** (default), 500,750,1000.

TForce4 / TForce4 Ultra

Security Option

This option will enable only individuals with passwords to bring the system online and/or to use the CMOS Setup Utility.

System A password is required for the system to boot and is also required to access the Setup Utility.

Setup (default) A password is required to access the Setup Utility only.
This will only apply if passwords are set from the Setup main menu.

APIC MODE

Selecting Enabled enables APIC device mode reporting from the BIOS to the operating system.

The Choices: Enabled (default), Disabled.

Note: If the CPU type is AMD 939 Dual Core, this item will be always "Enabled".

MPS Version Control For OS

The BIOS supports version 1.1 and 1.4 of the Intel multiprocessor specification.

Select version supported by the operation system running on this computer.

The Choices: 1.4 (default), 1.1.

OS Select For DRAM > 64MB

A choice other than Non-OS2 is only used for OS2 systems with memory exceeding 64MB.

The Choices: Non-OS2 (default), OS2.

Summary Screen Show

This item allows you to enable/ disable display the Summary Screen Show.

The Choices: Enabled (default), Disabled.

4 Advanced Chipset Features

This submenu allows you to configure the specific features of the chipset installed on your system. This chipset manage bus speeds and access to system memory resources, such as DRAM. It also coordinates communications with the PCI bus. The default settings that came with your system have been optimized and therefore should not be changed unless you are suspicious that the settings have been changed incorrectly.

■ Figure 4. Advanced Chipset Setup

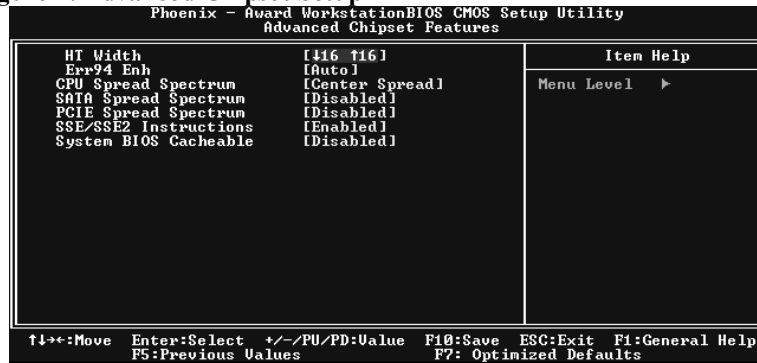

HT Width

This item allows you to control the utilized width of the outgoing side of the HyperTransport link.

Err94 Enh

This item allows you to enable/disable the “sequential Prefetch Feature” of K8 CPU.

The Choices: Auto (default).

CPU Spread Spectrum

The Choices: Center Spread (default).

SATA Spread Spectrum

This item allows you to disable \ enable the SATA spread spectrum function.

The Choices: Disabled (default), enable.

PCIe Spread Spectrum

This item allows you to disable \ enable the SATA spread spectrum function.

The Choices: Disabled (default), enable.

SSE/SSE2 Instructions

The Choices: Enabled (default), Disabled.

TForce4 / TForce4 Ultra

System BIOS Cacheable

Selecting the “Disabled ” option allows caching of the system BIOS ROM at F0000h-FFFFFh which can improve system performance. However, any programs writing to this area of memory will cause conflicts and result in system errors.
The Choices: **Disabled** (default), Enabled.

5 Integrated Peripherals

■ Figure 5. Integrated Peripherals

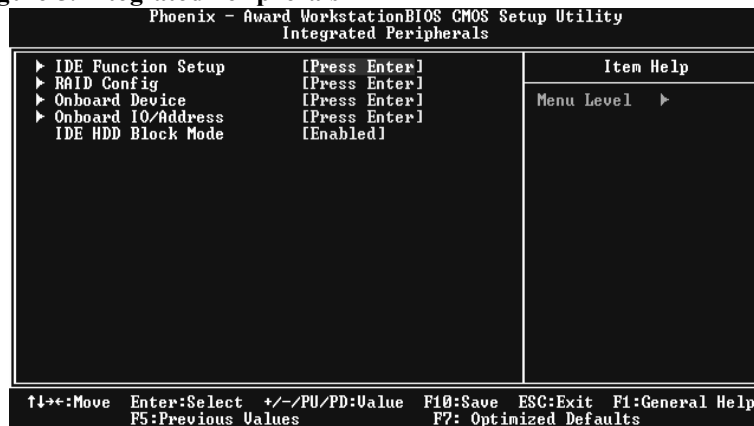

IDE Function Setup

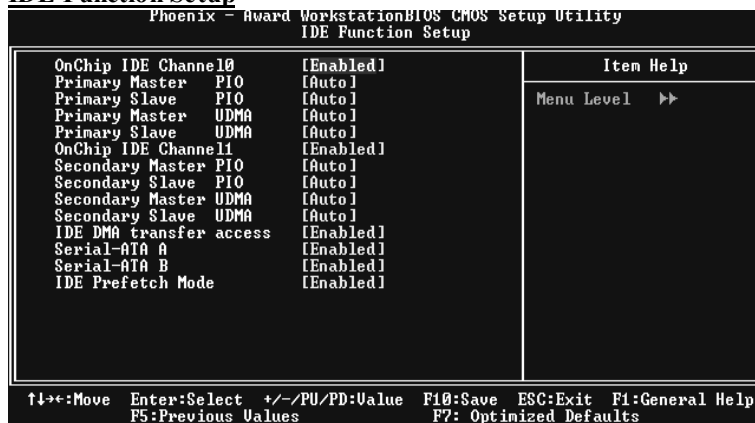

If you highlight the literal “Press Enter” next to the “IDE Function Setup” label and then press the enter key, it will take you a submenu with the following options:

OnChip IDE Channel 0/1

The motherboard chipset contains a PCI IDE interface with support for two IDE channels. Select “Enabled” to activate the first and/or second IDE interface. Select “Disabled” to deactivate an interface if you are going to install a primary and/or secondary add-in IDE interface.

The Choices: Enabled (default), Disabled.

TForce4 / TForce4 Ultra

Primary / Secondary /Master / Slave PIO

The IDE PIO (Programmed Input / Output) fields let you set a PIO mode (0-4) for each of the IDE devices that the onboard IDE interface supports. Modes 0 to 4 will increase performance progressively. In Auto mode, the system automatically determines the best mode for each device.

The Choices: Auto (default), Mode0, Mode1, Mode2, Mode3, Mode4.

Primary / Secondary /Master / Slave UDMA

Ultra DMA/100 functionality can be implemented if it is supported by the IDE hard drives in your system. As well, your operating environment requires a DMA driver (Windows 95 OSR2 or a third party IDE bus master driver). If your hard drive and your system software both support Ultra DMA/100, select Auto to enable BIOS support.

The Choices: Auto (default), Disabled.

IDE DMA Transfer Access

The Choices: Enabled (default), Disabled.

Serial-ATA A

Enables support for Serial-ATA A.

The Choices: Enabled (default), Disabled

Serial-ATA B

Enables support for Serial-ATA B.

The Choices: Enabled (default), Disabled

IDE Prefetch Mode

The Choices: Enabled (default), Disabled.

RAID Config

Phoenix - Award Workstation BIOS CMOS Setup Utility			
RAID Config			
RAID Enable	[Disabled]	Item Help	
x IDE Primary Master	RAID Disabled	Menu Level >>	
x IDE Primary Slave	RAID Disabled		
x IDE Secndry Master	RAID Disabled		
x IDE Secndry Slave	RAID Disabled		
x SATA A Primary	RAID Disabled		
x SATA A Secondary	RAID Disabled		
x SATA B Primary	RAID Disabled		
x SATA B Secondary	RAID Disabled		
↑↓: Move Enter: Select +/-/PU/PD: Uvalue F10: Save ESC: Exit F1: General Help			
F5: Previous Values F7: Optimized Defaults			

RAID Enable

The choices: Disabled (default), Enabled.

TForce4 / TForce4 Ultra

ONBOARD DEVICE

Phoenix - Award WorkstationBIOS CMOS Setup Utility		
Onboard Device		
		Item Help
OnChip USB	[U1_1+U2_0]	
USB Keyboard Support	[Disabled]	
USB Mouse Support	[Disabled]	
AC97 Audio	[Auto]	Menu Level >>
MAC Lan	[Auto]	
Onboard Lan Boot ROM	[Disabled]	
MAC Media Interface	[Pin Strap]	
Onboard 1394	[Enabled]	

↑↓←→:Move Enter:Select +/-/PU/PD:Value F10:Save ESC:Exit F1:General Help
F5:Previous Values F7: Optimized Defaults

OnChip USB

This option should be enabled if your system has a USB installed on the system board. You will need to disable this feature if you add a higher performance controller.

The Choices: V1. 1+V2. 0 (default), Disabled, V1. 1

USB keyboard Support

Enables support for USB attached keyboard.

The Choices: Disabled (default), Enabled

USB Mouse Support

Enables support for USB attached mouse.

The Choices: Disabled (default), Enabled

AC97 Audio

This option allows you to control the onboard AC97 audio.

The Choices: Auto (default), Disabled.

MAC LAN

This option allows you to change the state of the onboard MAC LAN.

The Choices: Auto (Default), Disabled.

Onboard LAN Boot ROM

This item allows you to enable or disable Onboard LAN Boot ROM.

The Choices: Disabled (default), Enabled.

MAC Media Interface

The Choices: Pin Strap (default).

Onboard 1394

This item allows you to enable or disable the Onboard 1394 Controller.

The Choices: Enabled (default), Disabled.

TForce4 / TForce4 Ultra

ONBOARD IO/Address

Phoenix - Award WorkstationBIOS CMOS Setup Utility	
Onboard IO/Address	
	Item Help
Onboard FDC Controller	[Enabled]
Onboard Serial Port 1	[3F8/IRQ4]
Onboard IR Function	[Disabled]
UART Mode Select	[IrDA]
UR2 Duplex Mode	[Half]
Onboard Parallel Port	[378/IRQ7]
Parallel Port Mode	[SPP]
ECP Mode Use DMA	[3]

↑↓←→:Move Enter:Select +/-/PU/PD:Value F10:Save ESC:Exit F1:General Help
F5:Previous Values F7: Optimized Defaults

Onboard FDC Controller

Select Enabled if your system has a floppy disk controller (FDC) installed on the system board and you wish to use it. If install and FDC or the system has no floppy drive, select Disabled in this field.

The Choices: Enabled (default), Disabled.

Onboard Serial Port 1

Select an address and corresponding interrupt for the first and second serial ports.

The Choices: Disabled, 3F8/IRQ4 (default), 2F8/IRQ3, 3E8/IRQ4, 2E8/IRQ3, Auto.

Onboard IR Function

The Choices: Disabled (default), Enabled.

UART Mode Select

This item allows you to determine which Infra Red (IR) function of onboard I/O chip.

The Choices: IrDA (default), AS KIR, Normal.

UR2 Duplex Mode

Select the value required by the IR device connected to the IR port. Full-duplex mode permits simultaneous two-direction transmission. Half-duplex mode permits transmission in one direction only at a time.

The Choices: Half (default), Full.

Onboard Parallel Port

This item allows you to determine access onboard parallel port controller with which I/O Address.

The Choices: 378/IRQ7 (default), 278/IRQ5, 3BC/IRQ7, Disabled.

TForce4 / TForce4 Ultra

Parallel Port Mode

The default value is SPP.

The Choices:

SPP(default) Using Parallel port as Standard Printer Port.
EPP Using Parallel Port as Enhanced Parallel Port.
ECP Using Parallel port as Extended Capabilities Port.
ECP+EPP Using Parallel port as ECP & EPP mode.

ECP Mode Use DMA

Select a DMA Channel for the port.

The Choices: 3 (default), 1.

IDE HDD Block Mode

Block mode is also called block transfer, multiple commands, or multiple sector read / write. If your IDE hard drive supports block mode (most new drives do), select Enabled for automatic detection of the optimal number of block mode (most new drives do), select Enabled for automatic detection of the optimal number of block read / write per sector where the drive can support.

The Choices: Enabled (default), Disabled.

6 Power Management Setup

The Power Management Setup Menu allows you to configure your system to utilize energy conservation and power up/power down features.

■ Figure 6. Power Management Setup

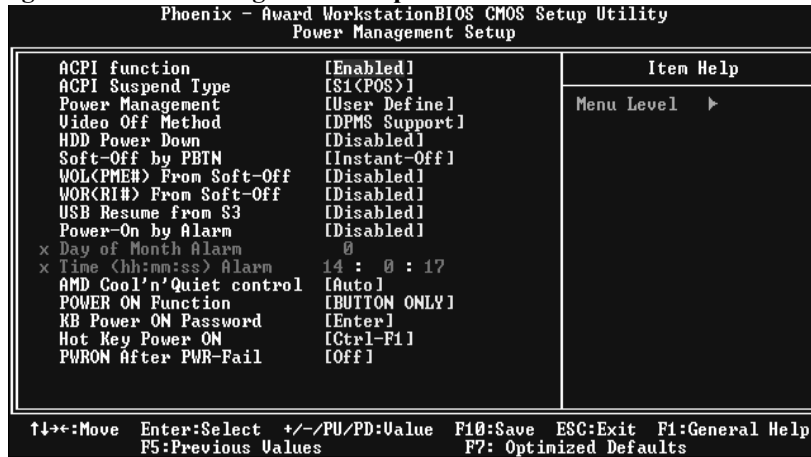

ACPI function

This item displays the status of the Advanced Configuration and Power Management (ACPI).

The Choices: Enabled (default), Disabled.

ACPI Suspend Type

The item allows you to select the suspend type under the ACPI operating system.

The Choices: S1 (POS) (default) Power on Suspend

S3 (STR) Suspend to RAM

S1+S3 POS+STR

Power Management

This category allows you to select the type (or degree) of power saving and is directly related to the following modes:

1. HDD Power Down.

2. Suspend Mode.

There are four options of Power Management, three of which have fixed mode settings

Min. Power Saving

Minimum power management.

Suspend Mode = 1 hr.

HDD Power Down = 15 min

Max. Power Saving

Maximum power management only available for sl CPU's.

Suspend Mode = 1 min.

HDD Power Down = 1 min.

TForce4 / TForce4 Ultra

User Define (default)

Allows you to set each mode individually.

When not disabled, each of the ranges are from 1 min. to 1 hr. except for HDD Power Down which ranges from 1 min. to 15 min. and disable.

Video Off Method

This option determines the manner in which the monitor is goes blank.

V/H SYNC+Blank

This selection will cause the system to turn off the vertical and horizontal synchronization ports and write blanks to the video buffer.

Blank Screen

This option only writes blanks to the video buffer.

DPMS (default)

Initial display power management signaling.

The Choices: Stop Grant, PwrOn Suspend.

HDD Power Down

When enabled, the hard disk drive will power down and after a set time of system inactivity. All other devices remain active.

The Choices: Disabled (default), 1 Min, 2 Min, 3 Min, 4 Min, 5 Min, 6 Min, 7 Min, 8 Min, 9 Min, 10 Min, 11 Min, 12 Min, 13 Min, 14 Min, 15Min.

Soft-Off by PWR-BTTN

Pressing the power button for more than 4 seconds forces the system to enter the Soft-Off state when the system has “hung.”

The Choices: Delay 4 Sec, Instant-Off (default).

WOL (PME#) From Soft-Off

The Choices: Disabled (default), Enabled.

WOR (RI#) From Soft-Off

The Choices: Disabled (default), Enabled.

USB Resume from S3

The Choices: Disabled (default), Enabled.

Power-On by Alarm

When you select Enabled, an alarm returns the system to Full ON state.

The Choices: Disabled (default), Enabled.

AMD K8 Cool'n' Quiet Control

This function supports AMD Cool 'n' Quick function.

The Choices: AUTO(default).

Power on Function

This option allows you to choose the different function to power on the computer.

The Choices: Button Only (default), Password, Mouse Move, Mouse Click, Any Key, Hot Key, Keyboard 98.

TForce4 / TForce4 Ultra

KB Power ON Password

Input password and press Enter to set the Keyboard power on password.

Hot Key Power on

This option allows you to choose a hot key to power on.

The Choices: Ctrl-F1 (default), Ctrl-F2, Ctrl-F3, Ctrl-F4, Ctrl-F5, Ctrl-F6, Ctrl-F7, Ctrl-F8

POWER After PWR-Fail

This setting specifies whether your system will reboot after a power fail or interrupts occurs.

Off Leaves the computer in the power off state.

On Reboots the computer.

Former-Sts Restores the system to the status before power failure or interrupt occurs.

The Choices: **Off** (default), **On**, **Former-Sts**.

7 PnP/PCI Configurations

This section describes configuring the PCI bus system. PCI, or Personal Computer Interconnect, is a system which allows I/O devices to operate at speeds nearing the speed of the CPU itself uses when communicating with its own special components. This section covers some very technical items and it is strongly recommended that only experienced users should make any changes to the default settings.

■ **Figure 7. PnP/PCI Configurations**

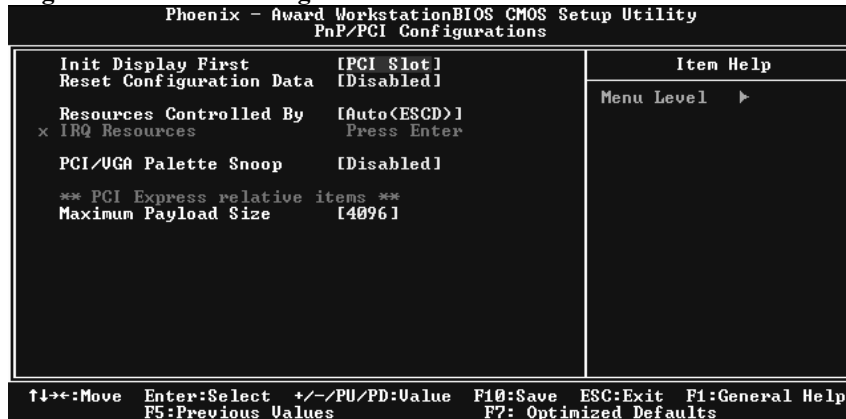

Init Display First

With systems that have multiple video cards, this option determines whether the primary display uses a PCI Slot or an AGP Slot.

The Choices: PCI Slot (default), AGP.

Reset Configuration Data

The system BIOS supports the PnP feature which requires the system to record which resources are assigned and protects resources from conflict. Every peripheral device has a node, which is called ESCD. This node records which resources are assigned to it. The system needs to record and update ESCD to the memory locations. These locations (4K) are reserved in the system BIOS. If the Disabled (default) option is chosen, the system's ESCD will update only when the new configuration varies from the last one. If the Enabled option is chosen, the system is forced to update ESCDs and then is automatically set to the "Disabled" mode.

The above settings will be shown on the screen only if "Manual" is chosen for the resources controlled by function.

Legacy is the term, which signifies that a resource is assigned to the ISA Bus and provides non-PnP ISA add-on cards. PCI / ISA PnP signifies that a resource is assigned to the PCI Bus or provides for ISA PnP add-on cards and peripherals.

The Choices: Disabled (default), Enabled.

TForce4 / TForce4 Ultra

Resources Controlled By

By Choosing “**Auto(ESCD)**” (default), the system BIOS will detect the system resources and automatically assign the relative IRQ and DMA channel for each peripheral. By Choosing “**Manual**”, the user will need to assign IRQ & DMA for add-on cards. Be sure that there are no IRQ/DMA and I/O port conflicts.

IRQ Resources

This submenu will allow you to assign each system interrupt a type, depending on the type of device using the interrupt. When you press the “Press Enter” tag, you will be directed to a submenu that will allow you to configure the system interrupts. This is only configurable when “Resources Controlled By” is set to “Manual”.

IRQ-3 assigned to PCI Device
IRQ-4 assigned to PCI Device
IRQ-5 assigned to PCI Device
IRQ-7 assigned to PCI Device
IRQ-9 assigned to PCI Device
IRQ-10 assigned to PCI Device
IRQ-11 assigned to PCI Device
IRQ-12 assigned to PCI Device
IRQ-14 assigned to PCI Device
IRQ-15 assigned to PCI Device

PCI/ VGA Palette Snoop

Choose Disabled or Enabled. Some graphic controllers which are not VGA compatible take the output from a VGA controller and map it to their display as a way to provide boot information and VGA compatibility.

However, the color information coming from the VGA controller is drawn from the palette table inside the VGA controller to generate the proper colors, and the graphic controller needs to know what is in the palette of the VGA controller. To do this, the non-VGA graphic controller watches for the Write access to the VGA palette and registers the snoop data. In PCI based systems, where the VGA controller is on the PCI bus and a non-VGA graphic controller is on an ISA bus, the Write Access to the palette will not show up on the ISA bus if the PCI VGA controller responds to the Write.

In this case, the PCI VGA controller should not respond to the Write, it should only snoop the data and permit the access to be forwarded to the ISA bus. The non-VGA ISA graphic controller can then snoop the data on the ISA bus. Unless you have the above situation, you should disable this option.

Disabled (default) Disables the function.
Enabled Enables the function.

Maximum Payload Size

Set the maximum payload size for Transaction packets (TLP).

The Choice: 4096 (default.)

8 PC Health Status

A. Figure 8. PC Health Status

Phoenix - Award WorkstationBIOS CMOS Setup Utility		Item Help
PC Health Status		Menu Level ▶
Chassis Open Warning	[Disabled]	
Shutdown Temperature	[Disabled]	
CPU FAN Control by	[Always ON]	
x CPU Fan Off(°C)	16	
x CPU Fan Start(°C)	32	
x CPU Fan Full speed(°C)	64	
x Start PWM Value	32	
x Slope PWM	1 PWM value/°C	
Show H/W Monitor in POST	[Enabled]	
CPU Vcore		
+ 1.5 V		
+ 3.3 V		
+ 5.0 V		
+12.0 V		
5V(SB)		
Voltage Battery		
CPU Temp		
Current CPU FAN Speed		
Current SVS FAN Speed		

↑↓+:-Move Enter:Select +/-PU/PD:Value F10:Save ESC:Exit F1:General Help
F5:Previous Values F7: Optimized Defaults

Chassis Open Warning

This item allows you to enable or disable Chassis Open Warning beep.

The Choices: Disabled (Default), Enabled.

Shutdown Temperature

This item allows you to set up the CPU shutdown Temperature. This item only effective under Windows 98 ACPI mode.

The Choices: Disabled (default), 60°C/140F, 65°C/149F, 70°C/158F, 75°C/167F.

CPU FAN Control by

The Choice “smart” can make your CPU FAN to reduce noise.

The Choices: SMART, Always On(default).

Show H/W Monitor in POST

If your computer contains a monitoring system, it will show PC health status during POST stage. The item offers several delay time for you to choose.

The Choices: Enabled (default), Disabled.

CPU Vcore/ +1.5V+3.3V/ +5.0V/ +12.0V/ 5VSB/ Voltage Battery

Detect the system’s voltage status automatically.

CPU Temperature

This field displays the current temperature of the CPU.

Current CPU FAN Speed

This field displays the current speed of CPU fan.

TForce4 / TForce4 Ultra

Current SYS FAN Speed

This field displays the current speed SYSTEM fan.

B 、 Figure 8. PC Health Status

The screenshot shows the BIOS PC Health Status screen. It lists various system health parameters and their current settings. The parameters include Chassis Open Warning, Shutdown Temperature, CPU FAN Control by, CPU Fan Off, CPU Fan Start, CPU Fan Full speed, Start PWM Value, Slope PWM, Show H/W Monitor in POST, CPU Vcore, Voltage Battery, CPU Temp, Current CPU FAN Speed, and Current SYS FAN Speed. The current values are: Chassis Open Warning [Disabled], Shutdown Temperature [Disabled], CPU FAN Control by [SMART], CPU Fan Off [16], CPU Fan Start [32], CPU Fan Full speed [52], Start PWM Value [32], Slope PWM [1 PWM value/°C], Show H/W Monitor in POST [Disabled], CPU Vcore +1.5 V, +3.3 V, +5.0 V, +12.0 V, Voltage Battery 5V(SB), CPU Temp, Current CPU FAN Speed, and Current SYS FAN Speed. The screen also displays navigation instructions at the bottom: ↑↓←→:Move, Enter:Select, +/-/PU/PD:Value, F10:Save, ESC:Exit, F1:General Help, F5:Previous Values, and F7: Optimized Defaults.

Item	Value	Item Help
Chassis Open Warning	[Disabled]	Menu Level ▶
Shutdown Temperature	[Disabled]	
CPU FAN Control by	[SMART]	
CPU Fan Off($^{\circ}\text{C}$)	[16]	
CPU Fan Start($^{\circ}\text{C}$)	[32]	
CPU Fan Full speed($^{\circ}\text{C}$)	[52]	
Start PWM Value	[32]	
Slope PWM	[1 PWM value/$^{\circ}\text{C}$]	
Show H/W Monitor in POST	[Disabled]	
CPU Vcore	+ 1.5 V	
	+ 3.3 V	
	+ 5.0 V	
	+12.0 V	
Voltage Battery	5V(SB)	
CPU Temp		
Current CPU FAN Speed		
Current SYS FAN Speed		

Chassis Open Warning

This item allows you to enable or disable Chassis Open Warning beep.

The Choices: Disabled (Default), Enabled.

Shutdown Temperature

This item allows you to set up the CPU shutdown Temperature. This item only effective under Windows 98 ACPI mode.

The Choices: Disabled (default), 60°C/140F, 65°C/149F, 70°C/158F, 75°C/167F.

CPU FAN Control by

The Choice “smart” can make your CPU FAN to reduce noise.

The Choices: SMART(default), Always On.

CPU Fan Off$^{\circ}\text{C}$>

If the CPU Temperature is lower than the set value, FAN will turn off.

The Choices: 16 (default).

CPU Fan Start$^{\circ}\text{C}$>

CPU fan starts to work under smart fan function when arrive this set value.

The Choices: 32(default).

CPU Fan Full speed$^{\circ}\text{C}$>

When CPU temperature is arriving the set value, the CPU fan will work under Full Speed.

The Choices: 52(default).

TForce4 / TForce4 Ultra

Start PWM Value

The Choices: 32 (default).

Slope PWM

The Choices: 1 PWM Value/°C (default), 2 PWM Value/°C, 4 PWM Value/°C, 8 PWM Value/°C, 16 PWM Value/°C, 32 PWM Value/°C, 64 PWM Value/°C.

Show H/W Monitor in POST

If your computer contains a monitoring system, it will show PC health status during POST stage. The item offers several delay time for you to choose.

The Choices: Disabled (default), Enabled.

CPU Vcore/ +1.5V+3.3V/ +5.0V/ +12.0V/ 5V<SB>/ Voltage Battery

Detect the system's voltage status automatically.

CPU Temperature

This field displays the current temperature of the CPU.

Current CPU FAN Speed

This field displays the current speed of CPU fan.

Current SYS FAN Speed

This field displays the current speed SYSTEM fan.

9 Over Clock Navigator Engine

```

Phoenix - Award WorkstationBIOS CMOS Setup Utility
OverClock Navigator Engine

Overclock Navigator      [Normal]
===== Automate Overclock System =====
x Auto Overclock System  U6 -Tech Engine
===== Manual Overclock System =====
** CPU Spec Voltage **   1.500U
** NB/SB Spec Voltage ** 1.52U
** Memory Spec Voltage ** 2.60U
x CPU Voltage             StartUp
x NB/SB Voltage Regulator 1.52U
x Memory Voltage          2.60U

x CPU Frequency           200
x Hammer CPU Multiplier  StartUp
x HT Frequency            Auto
x PCIE Clock              100Mhz
x Memclock Frequency      200Mhz
x 1T/2T Memory Timing    2T
x DRAM Configuration      Press Enter
Integrated Memory Test    [Disabled]

Item Help
Menu Level  ▶

↑↓←→:Move  Enter:Select  +/-/PU/PD:Ualue  F10:Save  ESC:Exit  F1:General Help
F5:Previous Values  F7: Optimized Defaults
    
```

Automate Overclock System

```

Phoenix - Award WorkstationBIOS CMOS Setup Utility
OverClock Navigator Engine

Overclock Navigator      [Automate Overclock]
===== Automate Overclock System =====
Auto Overclock System    [U6 -Tech Engine]
===== Manual Overclock System =====
** CPU Spec Voltage **   1.500U
** NB/SB Spec Voltage ** 1.52U
** Memory Spec Voltage ** 2.60U
x CPU Voltage             StartUp
x NB/SB Voltage Regulator 1.52U
x Memory Voltage          2.60U

x CPU Frequency           200
x Hammer CPU Multiplier  StartUp
x HT Frequency            Auto
x PCIE Clock              100Mhz
x Memclock Frequency      200Mhz
x 1T/2T Memory Timing    2T
x DRAM Configuration      Press Enter
Integrated Memory Test    [Disabled]

Item Help
Menu Level  ▶
U6 -Engine for Extra Performance
U8 -Engine for Extreme Performance
U12-Engine for Extraordinary Performance

↑↓←→:Move  Enter:Select  +/-/PU/PD:Ualue  F10:Save  ESC:Exit  F1:General Help
F5:Previous Values  F7: Optimized Defaults
    
```

A.O.S. is designed for beginners in overclock field.

Based on many test and experiments from BET, A.O.S. provide 3 default overclock configurations that are able to raise the system performance

TForce4 / TForce4 Ultra

- **V6 Tech Engine:**

Phoenix - Award WorkstationBIOS CMOS Setup Utility OverClock Navigator Engine		Item Help
Overclock Navigator [Automate Overclock] ===== Automate Overclock System ===== Auto Overclock System [U6 -Tech Engine] ===== Manual Overclock System ===== ** CPU Spec Voltage ** 1.500U ** NB/SB Spec Voltage ** 1.52U ** Memory Spec Voltage ** 2.60U x CPU Voltage StartUp x NB/SB Voltage Regulator 1.52U x Memory Voltage 2.60U x CPU Frequency 200 x Hammer CPU Multiplier StartUp x HT Frequency Auto x PCIE Clock 100Mhz x Memclock Frequency 200Mhz x iT/2T Memory Timing 2T x DRAM Configuration Press Enter Integated Memory Test [Disabled]	Menu Level ▶ U6 -Engine for Extra Performance U8 -Engine for Extreme Performance U12-Engine for Extraordinary Performance	
↑↓←→:Move Enter:Select +/-/PU/PD:Value F10:Save ESC:Exit F1:General Help F5:Previous Values F7: Optimized Defaults		

- **V8 Tech Engine**

Phoenix - Award WorkstationBIOS CMOS Setup Utility OverClock Navigator Engine		Item Help
Overclock Navigator [Automate Overclock] ===== Automate Overclock System ===== Auto Overclock System [U8 -Tech Engine] ===== Manual Overclock System ===== ** CPU Spec Voltage ** 1.500U ** NB/SB Spec Voltage ** 1.52U ** Memory Spec Voltage ** 2.60U x CPU Voltage StartUp x NB/SB Voltage Regulator 1.52U x Memory Voltage 2.60U x CPU Frequency 200 x Hammer CPU Multiplier StartUp x HT Frequency Auto x PCIE Clock 100Mhz x Memclock Frequency 200Mhz x iT/2T Memory Timing 2T x DRAM Configuration Press Enter Integated Memory Test [Disabled]	Menu Level ▶ U6 -Engine for Extra Performance U8 -Engine for Extreme Performance U12-Engine for Extraordinary Performance	
↑↓←→:Move Enter:Select +/-/PU/PD:Value F10:Save ESC:Exit F1:General Help F5:Previous Values F7: Optimized Defaults		

This setting will raise about 15%~25% of whole system performance.

TForce4 / TForce4 Ultra

- **V12 Tech Engine**

Phoenix - Award WorkstationBIOS CMOS Setup Utility OverClock Navigator Engine		Item Help
Overclock Navigator [Automate Overclock] ===== Automate Overclock System ===== Auto Overclock System [U12-Tech Engine] ===== Manual Overclock System ===== ** CPU Spec Voltage ** 1.500U ** NB/SB Spec Voltage ** 1.52U ** Memory Spec Voltage ** 2.60U x CPU Voltage StartUp x NB/SB Voltage Regulator 1.52U x Memory Voltage 2.60U x CPU Frequency 200 x Hammer CPU Multiplier StartUp x HT Frequency Auto x PCIE Clock 100Mhz x Memclock Frequency 200Mhz x 1T/2T Memory Timing 2T x DRAM Configuration Press Enter Integrated Memory Test [Disabled]	Menu Level ▶ U6 -Engine for Extra Performance U8 -Engine for Extreme Performance U12-Engine for Extraordinary Performance	
↑↓←→:Move Enter:Select +/-/PU/PD:Value F10:Save ESC:Exit F1:General Help F5:Previous Values F7: Optimized Defaults		

This setting will raise about 25%~30% of whole system performance.

Cautions:

1. Not all types of AMD CPU perform above overclock setting ideally; the difference will be based on the selected CPU model.
2. From BET experiment, the Athlon64 FX CPU are not suitable for this A.O.S. feature.

Manual Overclock System (M.O.S.)

Phoenix - Award WorkstationBIOS CMOS Setup Utility OverClock Navigator Engine		Item Help
Overclock Navigator [Manual Overclock] ===== Automate Overclock System ===== x Auto Overclock System U6 -Tech Engine ===== Manual Overclock System ===== ** CPU Spec Voltage ** 1.500U ** NB/SB Spec Voltage ** 1.52U ** Memory Spec Voltage ** 2.60U CPU Voltage [StartUp] NB/SB Voltage Regulator [1.52U] Memory Voltage [2.60U] CPU Frequency [200] Hammer CPU Multiplier [StartUp] HT Frequency [Auto] PCIE Clock [100Mhz] Memclock Frequency [200Mhz] 1T/2T Memory Timing [2T] ▶ DRAM Configuration [Press Enter] Integrated Memory Test [Disabled]	Menu Level ▶	
↑↓←→:Move Enter:Select +/-/PU/PD:Value F10:Save ESC:Exit F1:General Help F5:Previous Values F7: Optimized Defaults		

MOS is designed for experienced overclock users.
 It allows users to customize personal overclock setting.

Cautions:

According tests have been done; AMD 3000+ CPU is the best CPU type for overclock function.

CPU Voltage

This item allows you to select CPU Voltage Control.

The Choices: StartUp (default), 1.725V, 1.700V, 1.675V, 1.650V, 1.625V, 1.600V etc.

TForce4 / TForce4 Ultra

NB/SB Voltage Ragurator

The Choices:1.52V(default),1.60V,1.68V,1.76V.

Memorry Voltage

The Choices:2.60V(default),2.70V,2.80V,2.90V.

CPU Frequency

This item allows you to select the CPU Frequency.

The Choices: **200** (default),201,202,203,204,205,206,207,208,209.....450.(Max.is 450)

Hammer CPU Multiplier

The Max. value will be different from the selected CPU types.

The Choices: **StartUp** (default),X4 800MHz, X5 1000MHz, X6 1200MHz, X7 1400MHz, X8 1600MHz, X9 1800MHz, etc.

HT Frequency

This item allows you to select the HT Frequency.

The Choices: **4x** (default),1x,2x,3x,5x.Auto,x4.

PCIE Clock

The Choices:100MHz(default), 101MHz, 102MHz, 103MHz, 104MHz, 105MHz, 106MHz, 107MHz, etc.

Memclock Frequency

The Choices:200MHz(default), 100MHz, 133MHz, 166MHz, 200MHz, 216MHz, 233MHz, 250MHz.

1T/2T Memory Timing

The Choices:2T(default),1T.

RAM Configuration

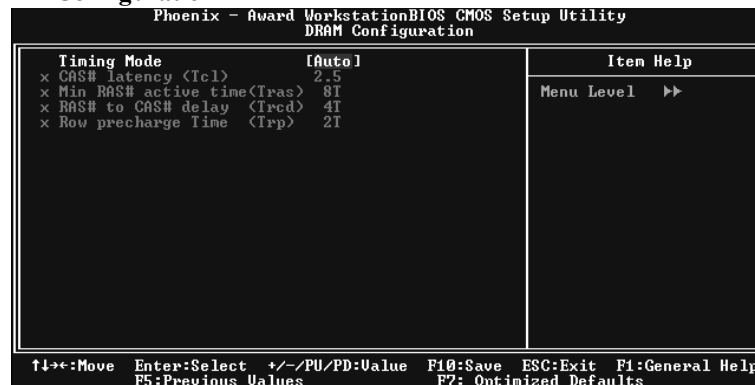

TForce4 / TForce4 Ultra

Timing Mode

DDR Timing Setting by SPD or ITEM.

The Choices: Auto (Default), Manual.

CAS# Latency(Tcl)

This field specify the cas# latency, i.e. cas# to read data valid.

The Choices: CL=2.5(Default), CL=3.0, CL=2.0,

Min RAS# active time (Tras)

This field specifies the minimum RAS# active time. Typically -45-60 Nsec.

The Choices: 8T(Default).

RAS# to CAS# Delay (Tred)

This field specifies the RAS# to CAS# Delay to read/ write command to the same bank. Typically -20 Nsec.

The Choices: 4T(Default).

Row precharge Time (Trp)

This field specifies the Row precharge Time. Precharge to Active or Auto-Refresh of the same bank. Typically 20-24 Nsec.

The Choices: 2T (Default).

Integated Memory Test

Integated Memory Test allows users to test memory compatibilities, and no extra devices or software are needed.

Step 1:

The default setting under this item is “Disable”, the condition should be change into “Enable” to proceed this test.

```

Phoenix - Award WorkstationBIOS CMOS Setup Utility
OverClock Navigator Engine

----- Automate Overclock System -----
x Auto Overclock System      U6 -Tech Engine
----- Manual Overclock System -----
** CPU Spec Voltage **      1.500U
** NB/SB Spec Voltage **    1.52U
** Memory Spec Voltage **   2.60U
x CPU Voltage                StartUp
x NB/SB Voltage Regulator    1.52U
x Memory Voltage             2.60U

x CPU Frequency              200
x Hammer CPU Multiplier     StartUp
x HT Frequency               Auto
x PCIE Clock                 100Mhz
x Memclock Frequency        200Mhz
x 1T/2T Memory Timing       2T
x DRAM Configuration        Press Enter
Integated Memory Test       [Disabled]

Item Help
Menu Level  ▶

↑↓←→:Move  Enter:Select  +/-/PU/PD:Value  F10:Save  ESC:Exit  F1:General Help
F5:Previous Values  F7: Optimized Defaults
  
```

TForce4 / TForce4 Ultra

Step 2:

When the process is done, change the setting back from “Enable” to “Disable” to complete the test.

```
Phoenix - Award WorkstationBIOS CMOS Setup Utility
OverClock Navigator Engine

Overclock Navigator [Normal]
===== Automate Overclock System =====
x Auto Overclock System U6 Tech Engine
===== Manual Overclock System =====
** CPU Spec Voltage ** 1.500U
** NB/SB Spec Voltage ** 1.52U
** Memory Spec Voltage ** 2.60U
x CPU Voltage StartUp
x NB/SB Voltage Regulator 1.52U
x Memory Voltage 2.60U

x CPU Frequency 200
x Hammer CPU Multiplier StartUp
x HT Frequency Auto
x PCIE Clock 100Mhz
x Memclock Frequency 200Mhz
x 1T/2T Memory Timing 2T
x DRAM Configuration Press Enter
Integrated Memory Test [Enabled]

Item Help
Menu Level ▶

↑↓←→:Move Enter:Select +/-/PU/PD:Value F10:Save ESC:Exit F1:General Help
F5:Previous Values F7: Optimized Defaults
```

10 CMOS Reload Program(C.R.P.)

It allows users to save different CMOS settings into BIOS-ROM.

Users are able to reload any saved CMOS setting to change system configurations.

Moreover, users are able to save ideal overclock setting when under overclock operation.

There are 50 sets record addresses in total, and users are able to name the CMOS data according to personal like.

